



USER MANUAL



NA6 SODIUM ANALYZER



Electrical equipment marked with this symbol cannot be disposed of through home or public waste disposal systems. In accordance with local and national regulations (e.g., the Resource Conservation and Recovery Act (RCRA) and state e-waste laws), users must return equipment that is no longer functional or usable to designated e-waste collection centers or recycling facilities.

Note: To return devices at the end of their useful life, including accessories supplied by the manufacturer and all auxiliary items for recycling, contact the manufacturer, the vendor of the device, or your local waste management authority to arrange proper disposal.

INDEX

1 - SAFETY INFORMATION

Before installing and operating the analyzer, read this manual thoroughly. Please pay particular attention to all the labels applied to the analyzer and to all the hazard information indicators in this manual.



This symbol indicates that you must refer to this manual for proper use of the equipment. Only qualified operators, properly trained on the use and maintenance of the analyzer can carry out service activities on the equipment.



This symbol indicates the existence of a risk of electric shock and/or electrocution.

Only operators qualified for these activities can perform maintenance and control operations on the equipment bearing this label, always after unplugging it.

Parts involved:

- input terminal block in the upper box
- xenon lamp and its power wires in the lower liquid section



This symbol indicates the risk of burns and physical damage caused by the presence of hazardous chemical compounds.

Only operators qualified for these activities can handle and perform service operations that may involve the risk of contact with such compounds. Before carrying out any type of service activities on the analyzer, please read the safety data sheets of the different chemicals used and take all precautions specified therein.

Parts involved:

- buffer reagent bottle
- buffer reagent tubing

The manufacturer shall not be held responsible under any circumstances for improper use of the equipment.

The head of department and the machine operator must comply with the following rules and with the provisions of current legislation on the safety and health of workers.

The use, maintenance, and repair of the analyzer are permitted only to persons authorised for such operations. These operators must be physically and mentally capable to perform such activities, which can not be performed under the influence of alcohol and drugs.

When the analyzer is not being used it must be protected from voluntary or involuntary activation, after disconnecting the power supply.

Failure to follow the instructions given and/or failure to pay attention to the hazard indicators may cause serious risks of physical damage to operators and breaks or malfunctioning of the analyzer.

All the components of the analyzer are placed within a panel closed by a door with a special key, supplied only to maintenance operators.

The analyzer must, then, be used under operating conditions with both lower and upper doors closed.

2 - GENERAL INFORMATION

2.1 Technical specification

Measured parameters	Sodium ion, Na ⁺ (ppb, ppm)
Measuring principle	Potentiometric detection with glass electrode and reference (or combined electrode)
Measuring range	Selectable full scale from 10 ppb to 20 ppm
Lower detection limit	0.01 ppb
Accuracy	± 5% of the reading or ± 0.1 ppb at calibration temperature
Analysis Frequency	Continuous operation.
Calibration	Manual or automatic, 1-point or 2-point calibration
Sample	Pressure: Atmospheric Temperature: 5 - 50 °C (41 - 122 °F) Flow Rate: 80 to 500 ml/min Connection: 6 mm (¼-in.)
Drain	Pressure-free, atmospheric drain Connection: 12 mm (½-in.)
N° of streams	Up to 4 sample streams, 2 additional streams for standard solution(s)
Dimensions (H x W x D)	626 x 900 x 246 mm (24.6 x 35.5 x 9.7 in)
Weight	Approx. 30 kg (66 lbs)
Power Supply	Voltage: 100 - 240 VAC 50/60 Hz standard or 24 VDC (option) Power consumption: max. 80 VA
Outputs	4 x 4-20 mA outputs for measured data Modbus RTU RS485
Alarms	4 SPDT programmable potential free relays
Operative Conditions	Temperature: 5 - 55 °C (41 - 131 °F) Humidity: 10 to 90% RH (indoor use only)
Installation	Wall mount (standard), panel mount (options).
Protection Grade	IP54
Maintenance frequency	Refill buffer solution (monthly). Electrode replacement (depending on samples). Pinch valve tubing replacement every 6 month

2.2 Method description

The NA6 is a multi-stream sodium analyzer for online measurement of the sodium content in aqueous solutions.

Potentiometric sodium analysis is a common technique used to measure the concentration of sodium ions in a solution. This method involves using an ion-selective electrode (ISE) that is specific to sodium ions, such as a sodium-sensitive glass electrode, to measure the potential difference between the solution being analyzed and the internal reference.

The potential difference generated by the ISE is proportional to the logarithm of the concentration of sodium ions in the solution, according to the Nernst equation. By measuring the potential difference between the ISE and reference electrode, the concentration of sodium ions in the solution can be determined. It is a relatively simple and quick method for determining the sodium concentration of a solution, with results available within seconds.

2.3 Applications

Low range sodium analysis is needed in ultrapure water production and find application in the food, pharmaceutical, cosmetics and power generation plants.

The NA6 analyzer is particularly suited for the sodium analysis in the ultra low ppb range where conventional sodium electrodes are inaccurate.

The determination in this low range is important for power plants where even traces of sodium can deliver damage to turbines and other equipments.

3 - INSTALLATION

3.1 Opening the package



Caution:
 please take all the precautions required for handling and lifting the box containing the analyzer.
 The instrument weight is approx. 30 kg (66 lbs)

For safety reasons, when removing the packaging of the equipment, please check for any visible defects and, if necessary, inform the supplier.



Content of the package	Code
Sodium analyzer including support panel with bottle rack	NA6-A-B-C-D-E
USB drive with user manual and factory tests	
User Manual	
Key for the instrument's door	
Sodium ISE Combined electrode	A462000100

NOTE: The electrode has to be ordered separately.

These are the codes to identify the different configuration analyzers

NA6-A-B-C-D-E

A. Parameter	
1	Sodium, manual calibration
2	Sodium, auto calibration

B. Range	
A	0.1 ppb - 10 ppm

C. Number of Streams	
1	Single (Select Manual or Automatic)
2	Dual (Automatic calibration)
3	Three (Automatic calibration)
4	Four (Automatic calibration)

D. Fast loop reservoir	
1	Always included

E. Reserved for future use	
0	Reserved

Example:

NA6-2-A-1-1-0

NA6 sodium analyzer (0.1 ppb - 10 ppm), single stream with autocalibration

3.2 Mounting the instrument

The analyzer must be mounted vertically on a wall with suitable screws (not included in the supply) to fasten it via the holes on the back panel. Mount them so as to get the display at eye height (160 cm / 5 feet).

Please consider that the surrounding space must allow easy opening of the doors (upper and lower) and to operate on the sampling rack.

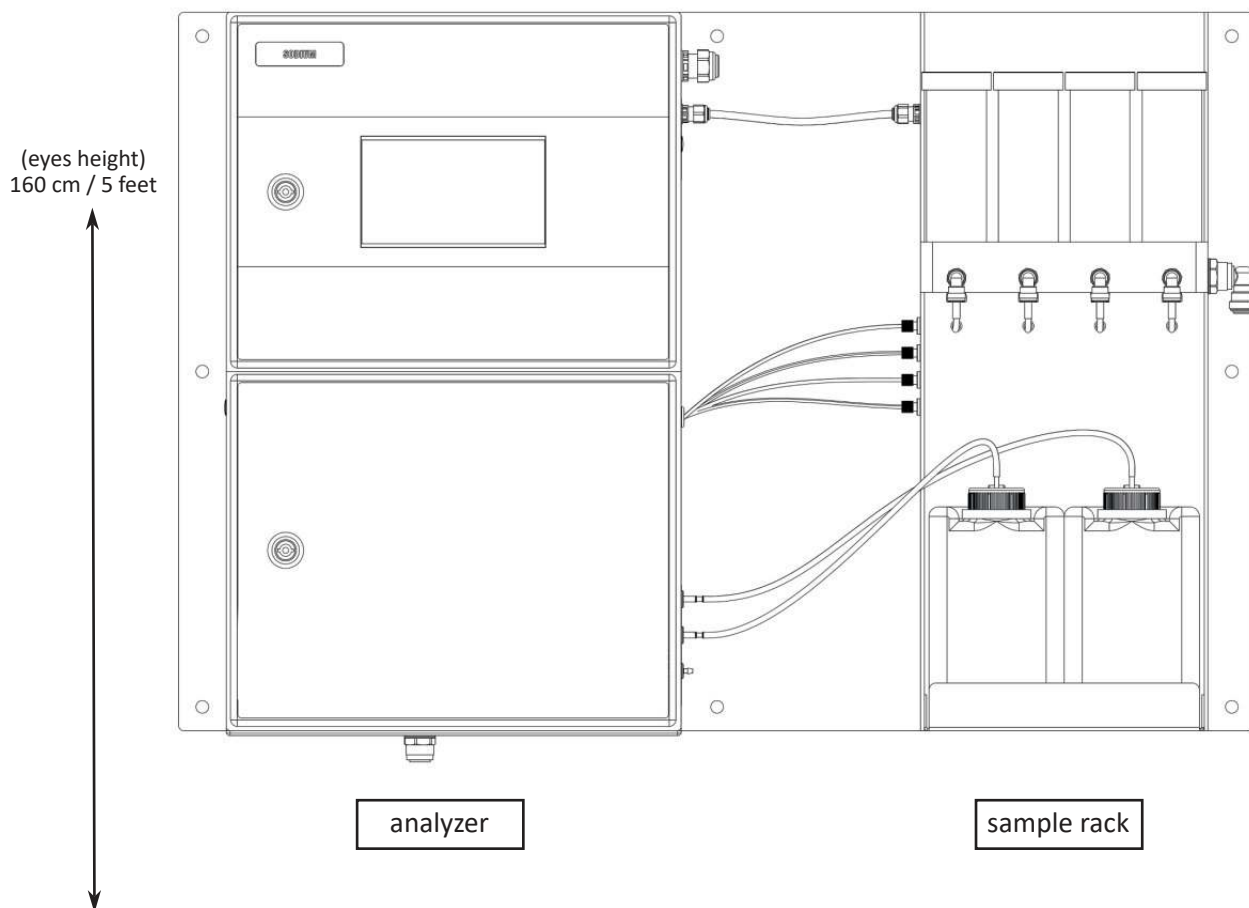

3.3 Wall mounting dimension

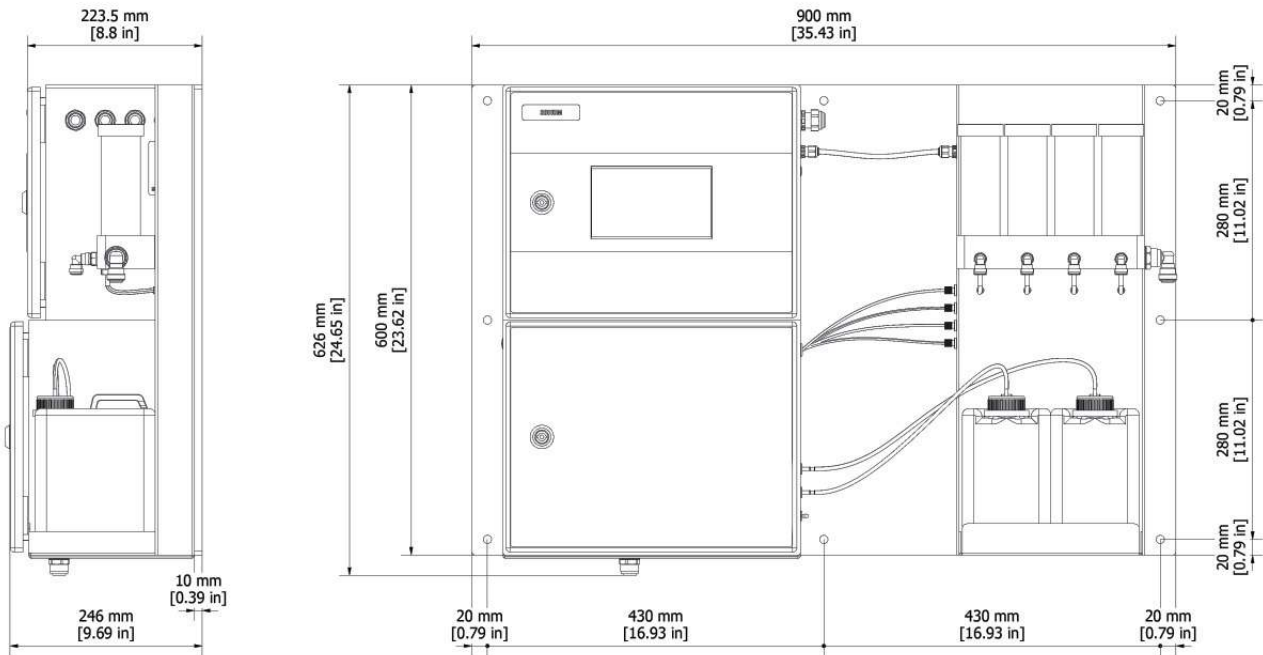

NOTE: all analyzer versions share the same mounting dimensions.

3.4 Power supply connection

The electrical power is supplied by the analyzer's cable with a CEE7/7 SCHUKO Europe plug

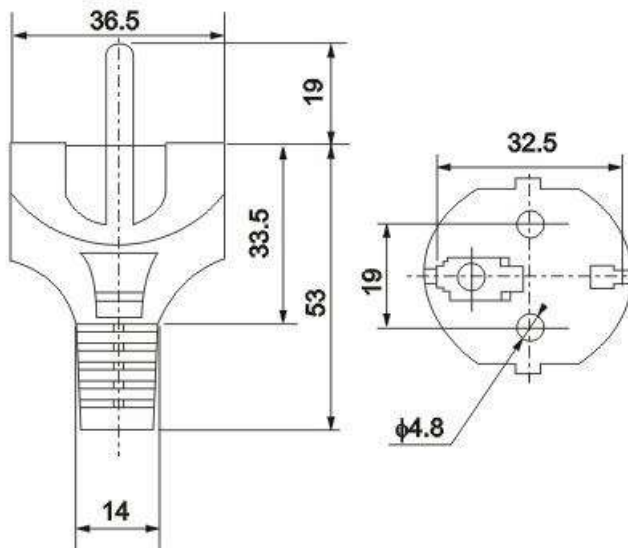

Length: 2.5 m

Color codes

- BROWN Live
- BLUE Neutral
- GREEN/YELLOW - Protective earth/ground

The analyzer, in accordance with CEI EN 61010-1 standard on electrical safety, has passed the following factory safety tests:

- continuity test
- protective earth test
- insulation resist test
- high voltage test AC
- leakage current test

In addition to the tests carried out by the manufacturer, the installer shall:

- make sure that the power cord was not damaged when the packaging was removed or when the instrument was fixed by the installer;
- check the condition of the earthing conductor of the socket where the power cord will be connected;
- provide adequate protection against overloads and over-voltages in the line where the power cord of the device will be connected;
- check for compliance of the power line with any applicable safety standards.

3.5 Signal connection to the data acquisition system

ModBUS TCP

Open the upper compartment of the analyzer and connect the ethernet cable to the RJ-45 socket on the back of the HMI panel.

ModBUS RTU

Proceed as follows:

- use up to 2 cables with a maximum diameter (insulation included) of 12 mm (0.5 in) ;
- pass the cables into the two free PG13.5 cable glands on the top right side of the instrument;
- a hole with a diameter of 30 mm on the top wall (to the left of the cable glands) can be used as an alternative to the 2 PG13.5 cable glands for a larger size cable gland (not supplied);
- remove the electrical insulator from each wire and place it into the terminal making up the terminal block on the top of the instrument. Use a screwdriver with a 3 mm (1/8 in) cutting width and make sure that the wire is secured inside the terminal;
- make sure that the cable glands are perfectly sealed to prevent dust and moisture infiltration;

Please refer to the connection diagram in the next page.

TERMINAL	CONNECTION	NOTES
1 2	RS485 Data - RS485 Data +	Two-wire ModBUS protocol
3 4 5 6 7	Relays COM N.O. RELAY 1 N.O. RELAY 2 N.O. RELAY 3 N.O. RELAY 4	Max 5 A 250 VAC normally open relay, configurable as normally excited
8 9 10 11 12	Analog Output COM (-) A.O. CH1 (+) A.O. CH2 (+) A.O. CH3 (+) A.O. CH4 (+)	Max impedance 500 ohm protected by 50 mA fuse

Relays are normally open (NO) but can be configured in failsafe mode. In this case they behave as normally closed (and continuously excited). The configuration applies to all relays.

3.6 Modbus serial protocol

The analyzer exchanges information over the serial line via Modbus RTU or TCP protocols in slave mode.

For the settings and the data exchange table, please follow the steps below.

Baud Rate	9600
Data bits	8
Parity	E
Stop bit	1
Analyzer I.D. (slave , node number)	The last two digits of the serial number i.e. s/n NA6-145 = I.D. no. 45)

Address	Format	Alias
900	32-bit float (CD-AB)	Result CH1
902	32-bit float (CD-AB)	Result CH2
904	32-bit float (CD-AB)	Result CH3
906	32-bit float (CD-AB)	Result CH4
908	32-bit integer	Calibration strength
800	bit	Result alarm A low
801	bit	Result alarm A high
802	bit	Result alarm B low
803	bit	Result alarm B high
804	bit	Result alarm C low
805	bit	Result alarm C high
806	bit	Result alarm D low
807	bit	Result alarm D high
808	bit	Calibration error

3.7 Connecting sample level sensor

The sample recirculation tanks positioned to the right of the device have a level contact showing the presence or absence of the sample. The signal reaches the device through a cable connected into its socket placed on the main electronic board. The sensors are already wired correctly and usually no modifications are required.

A label helps to identify the correct connection.

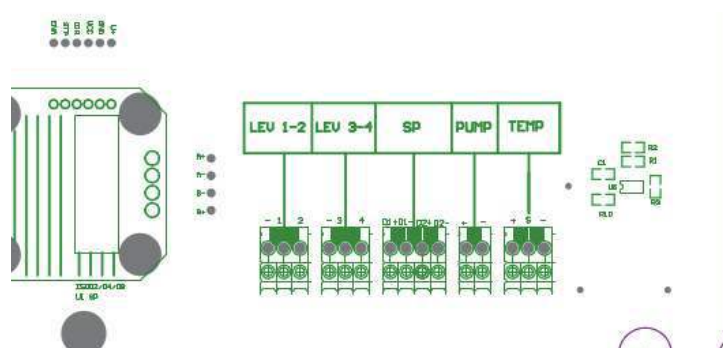

Below the contact logic :

SAMPLE PRESENT	floating element UP	Contact OPEN
SAMPLE NOT PRESENT	floating element DOWN	Contact CLOSED

3.8 Sample/Standard solution connection

Two 2-liter standard solution tanks are provided with the analyzer. They must be placed on the external sample rack.



The connections to the sample/standard solutions are different depending on the analyzer version.

NA6-1-A-1

The sample inlet is connected to the recirculating sample reservoir. The single straw for the standard solution(s) sits in its rest position on the sample rack. The analyzer is manual calibration only, the user is required to place the straw in the correct standard solution container during the calibration procedure.



NA6-2-A-1

The sample inlet is connected to the recirculating sample reservoir. The two straws for the standard solutions must be placed in the standard solution containers. The analyzer has autocalibration therefore the electromechanical valve switches the standard solutions automatically during the calibration procedure.

**NA6-2-A-2**

The sample inlet is connected to the two recirculating sample reservoirs. The two straws for the standard solutions must be placed in the standard solution containers. The analyzer has autocalibration therefore the electromechanical valve switches the standard solutions automatically during the calibration procedure as well as the two sample streams during online operation.



NA6-2-A-3**NA6-2-A-4**

The sample inlet is connected to the four recirculating sample reservoirs. The two straws for the standard solutions must be placed in the standard solution containers. The analyzer has autocalibration therefore the electromechanical valve switches the standard solutions automatically during the calibration procedure as well as the four sample streams during online operation.

The version with three streams is similar but is only equipped with three sample containers and three sample inlet lines.



3.9 Analyzer drain - waste connection

The analyzer drain must be connected to a waste line via the flexible tube 12 mm OD (0.5 in OD) provided with the analyzer. Please note that the liquid must be drained by allowing its free fall, therefore any backpressure have to be avoided.

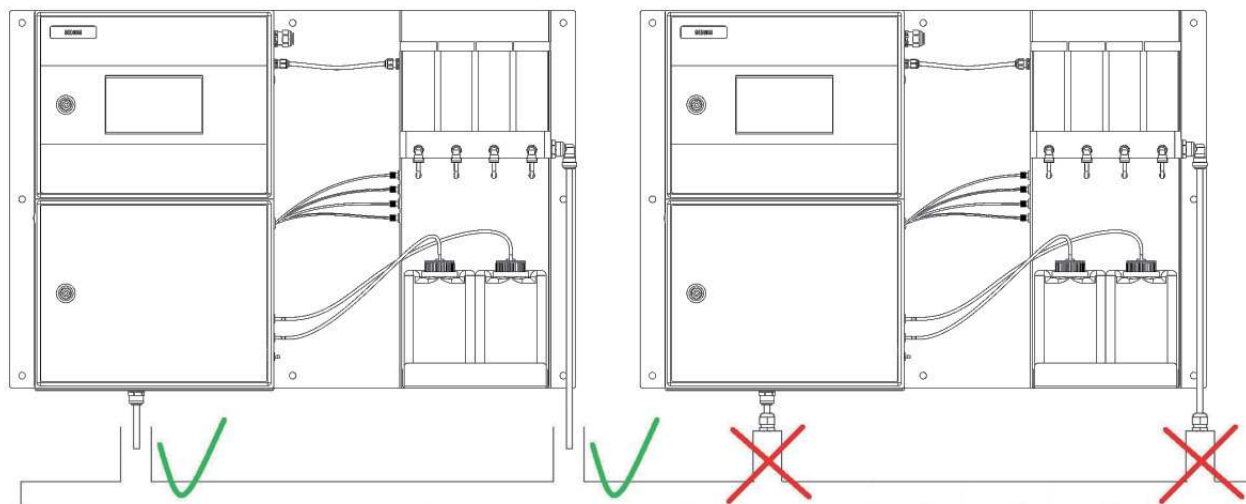

3.10 Analyzer - purge gas connection

The analyzer stainless steel enclosure is rated IP54. This makes the analyzer suitable for most industrial conditions. For extreme environments, where metal corrosion is a real issue, a purge gas line can be connected to the instrument to prevent corrosive gases to enter the analyzer.

The user must provide a purge gas line (nitrogen or clean air, 1 - 2 bar) and connect it to intake on the right side of the analyzer with a 6 mm OD pipe.

An internal flow regulator will provide a positive pressure inside the analyzer preventing ambient air to reach sensitive components.

The purge gas line does not replace a properly flushed cabinet required for ATEX areas.



3.11 Reagent bottle connection

To connect the vapor line from the buffer reagent solution, use the bottle provided with the "quick connect fitting" on the head of the vapor tubing.

The bottle should be placed in the suitable space in the bottom enclosure of the analyzer.

Please, refill the bottle with reagent solution under a fume hood.



Please pay close attention when handling the pipe and the cleaning reagent bottle if this has already been filled, at least once, with corrosive liquid. Use protective gloves and goggles to prevent any spilled liquid from coming in contact with the eyes and skin.



The reagent is required to adjust the pH. At low pH the hydrogen ion interferes with the electrode and gives false responses.

To counter this effect a volatile pH adjuster (ammonia or diisopropylamine) is bubbled into the sample stream to increase the pH.

4 - COMPONENTS

4.1 Knowledge of the standard components

Before using the analyzer you should be able to identify its standard components. To do this, open the lower compartment. Some components may vary, depending on the configuration of the analyzer. Here are the various options:

NA6-1-A-1

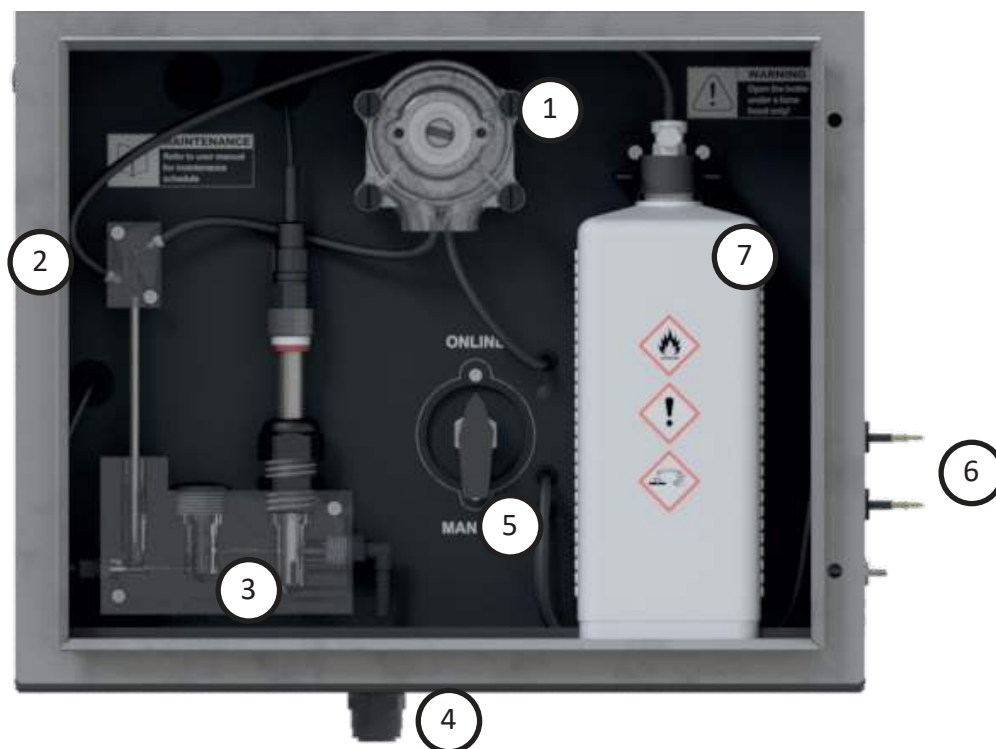

1	SAMPLING PUMP
2	VENTURI BUBBLER FOR pH ADJUSTER
3	SODIUM ISE
4	DRAIN
5	MANUAL VALVE
6	VENT/STANDARD SOL. CONNECTIONS
7	REAGENT BOTTLE FOR pH ADJUSTER

- NA6-2-A-1
- NA6-2-A-2
- NA6-2-A-3
- NA6-2-A-4

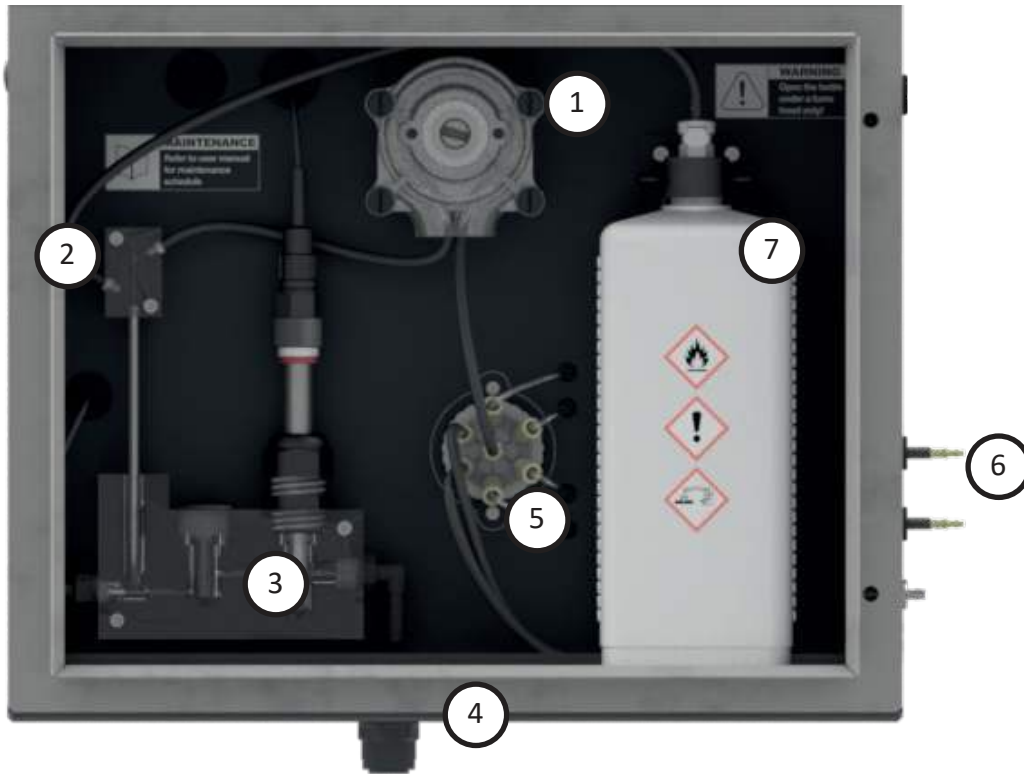

1	SAMPLING PUMP
2	VENTURI BUBBLER FOR pH ADJUSTER
3	SODIUM ISE
4	DRAIN
5	AUTOMATIC VALVE
6	VENT/STANDARD SOL. CONNECTIONS
7	REAGENT BOTTLE FOR pH ADJUSTER

4.2 External components

Other components mounted on the external samples rack are shown below.

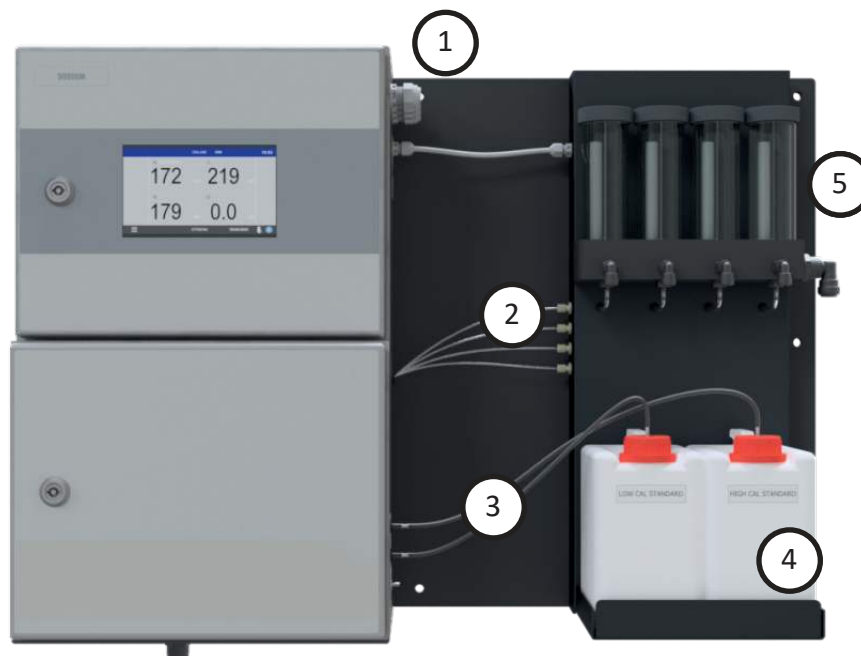

1	POWER SUPPLY AND SIGNAL CABLE GLANDS
2	SAMPLE INLETS (1 - 4)
3	STANDARD SOLUTIONS INLET
4	STANDARD SOLUTION TANKS
5	SAMPLE RECIRCULATING VESSELS

4.3 Switching valve

The NA6 versions with the automatic switching valve (NA6-2) have an internal sequencer functionality driven by the microcontroller. Those versions have a different maximum amount of sample streams (1 to 4) and two standard solution streams.

The analyzer automatically select the right stream according to the operation that must be performed, including all calibration operations (note: the stream assigned to the standard solution are 5 and 6 in all NA6 versions independently from the number of sample streams, this cannot be modified).



The NA6-1 version does not come with the automatic switching valve, a manual valve is used instead.

The analyzer has no sequencing capabilities and automatic calibration is not possible. During the manual calibration the user will be asked to switch the manual valve in the MANUAL position and to move the standard solution straw to the required standard solution.

The MANUAL position of the valve can be also used to analyze "manual" samples (from a bottle or other source).



4.4 Loss of sample

The analyzer uses two level contacts to verify the presence of the sample (see 3.7) by means of level sensors.

In this way if the sample or dilution water needed for the analysis is missing, the analysis will not proceed and the analyzer will put itself in standby. When the sample fills the external reservoir again the level sensor floater will rise up and the analyzer will start online analyses again, without needing any external intervention.

5 - USER INTERFACE

5.1 Power on

After checking for proper power supply, you can turn the device on through the switch located inside the upper compartment.

The analyzer display takes a few seconds to turn on, during which a splash screen appears followed by the main screen.

You will see the following main page:

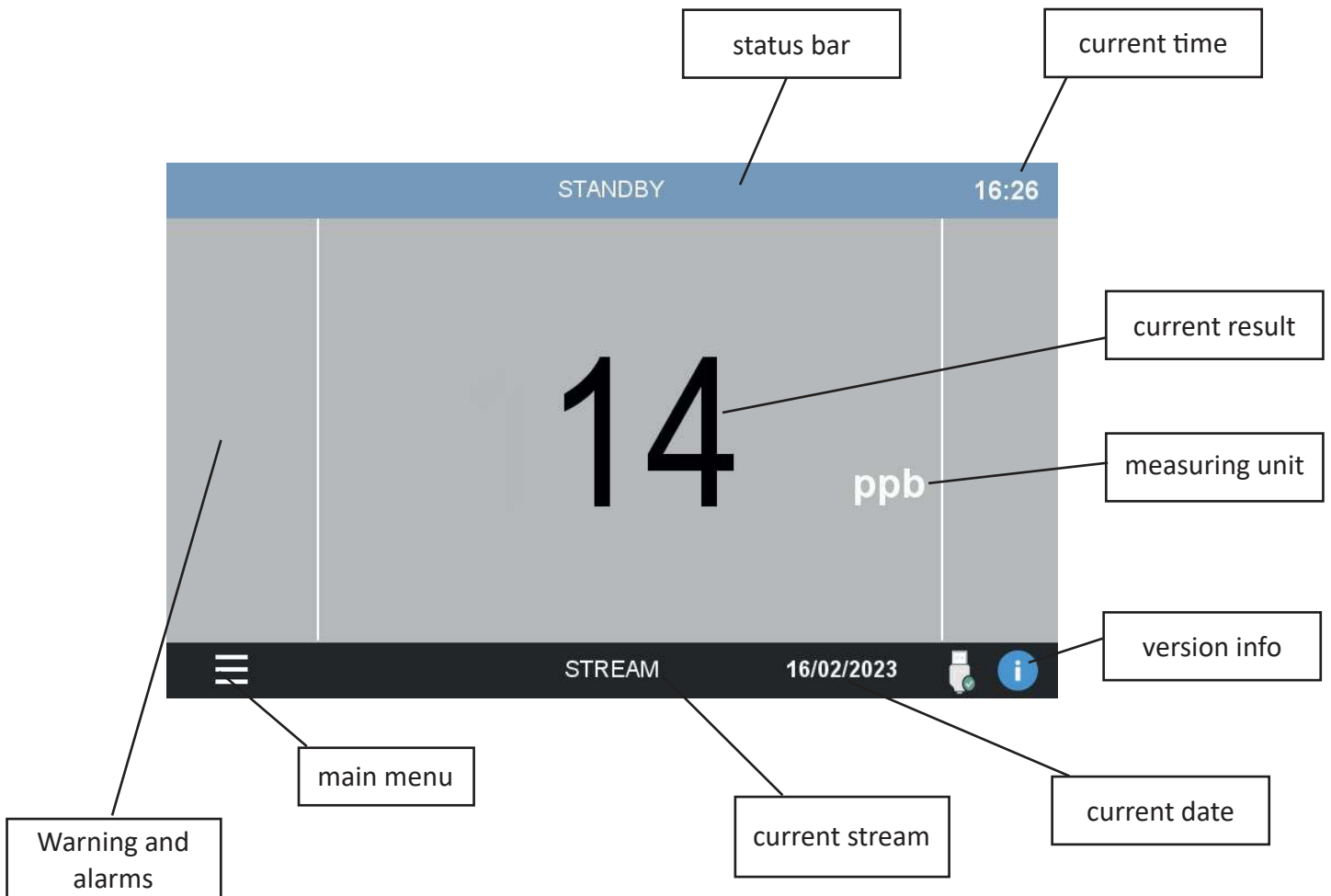

If the device was set to analyze 2 channels, you'll see an additional result value for channel B.

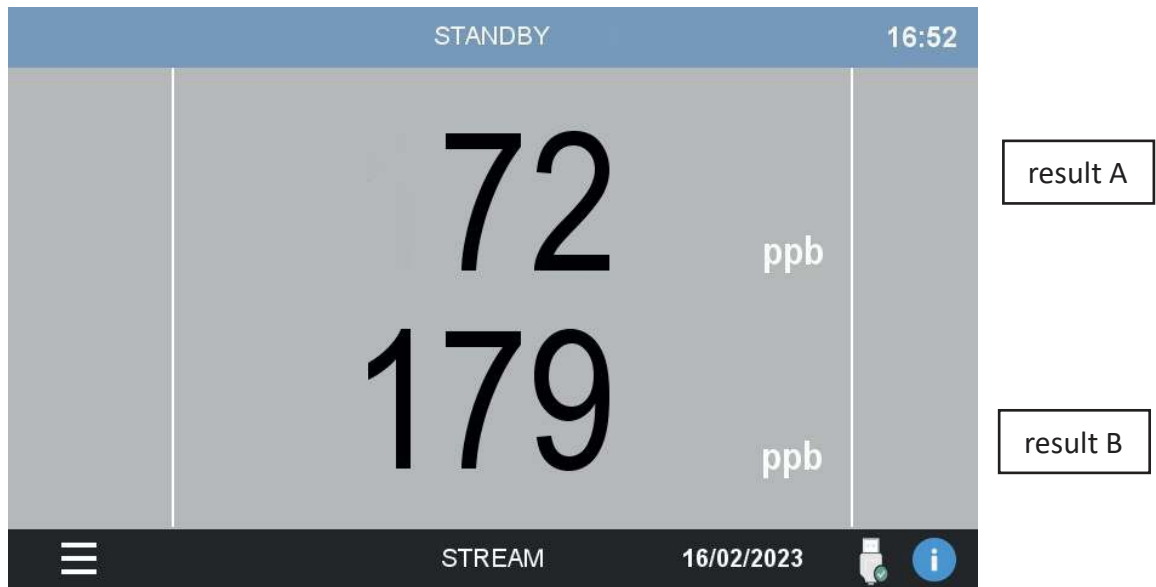

The 4-stream main page is also available.

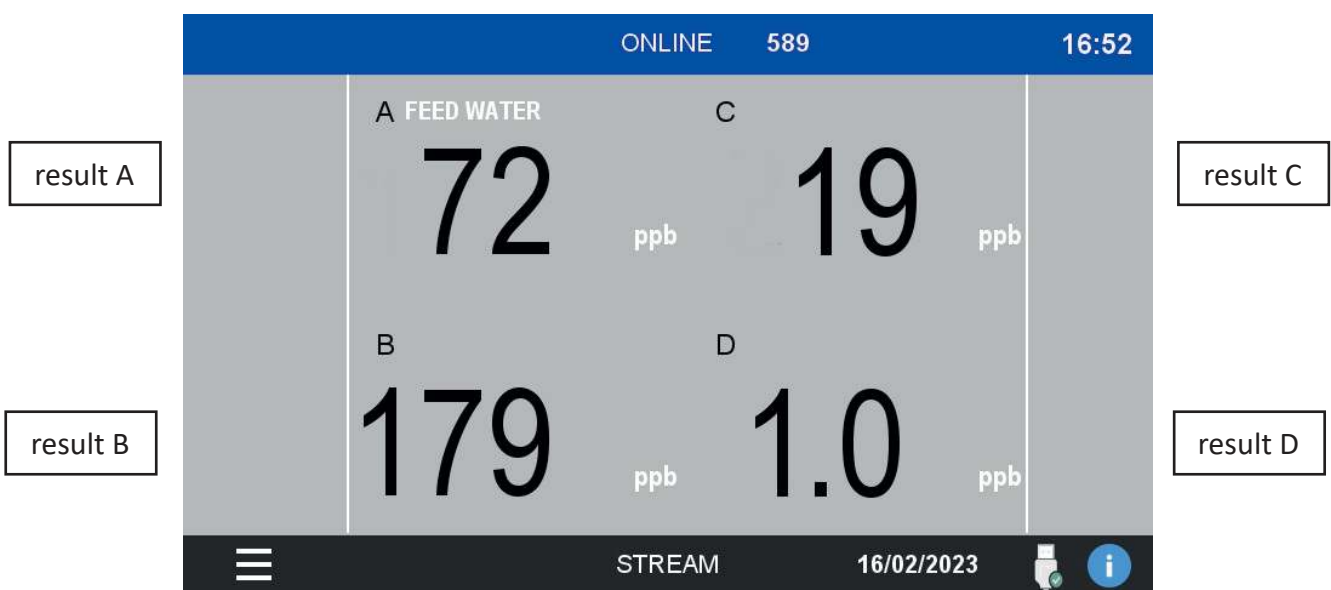

After some minutes of inactivity the screen will go black to save power.

5.2 Main menu

By tapping on the bottom left corner you will access the main menu. All the commands, options and configurations can be accessed from here.



5.3 Gaining access

To prevent undesired modifications to important configuration parameters, the access to the user interface is restricted on a login-based access menu. The user can log himself in by tapping on the ACCESS LOGIN entry of the main menu.



The analyzer has three levels of security, each level allows the user to access more advanced functions. The three levels are:

ADVANCED	This is the default level, the user can start or stop the analysis cycle and access data and trends but cannot modify calibrations or important settings
SERVICE	This level allows the user to perform calibrations and modify basic settings.
FACTORY	This level allows the user to alter system-wide settings. Reserved for factory setup.

Contact the ECDAnalyzers technical service or your local supplier to receive the password for your analyzer. You can write it down below.

SERVICE PASSWORD _____

To access the analyzer menu with the required security level tap on ACCESS LOGIN in the main menu.

Press on **** to display the numerical pad and enter your password.

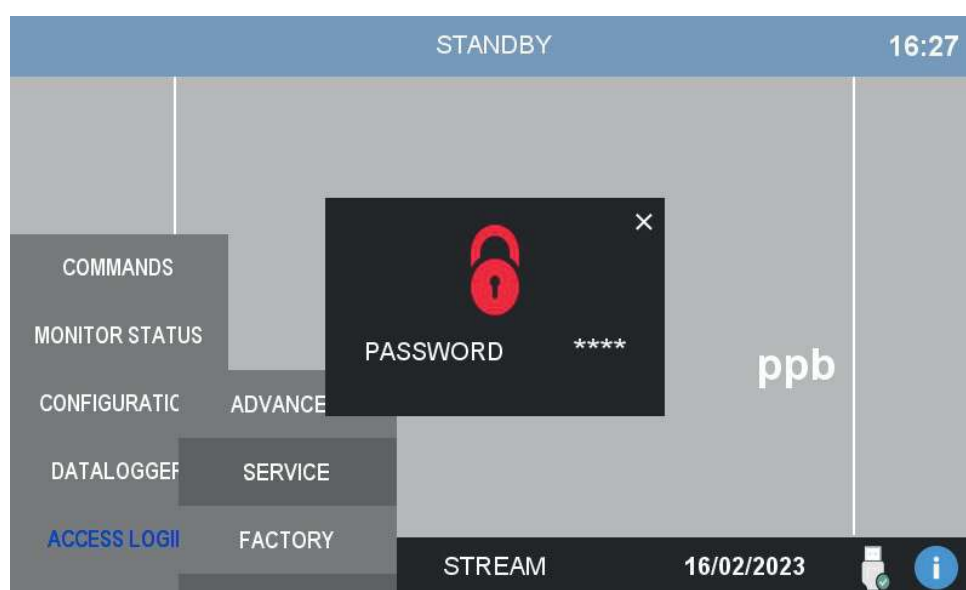

If the password for the selected access level is correct, the lock symbol becomes green.

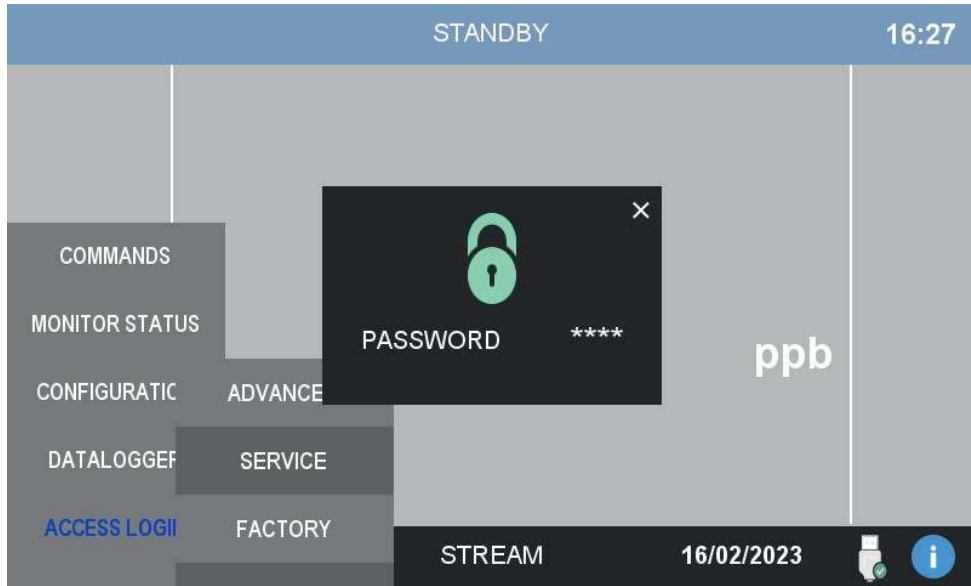

5.4 Commands

In the COMMANDS menu the user can give orders to the analyzer, such as starting a new analysis or perform calibrations.

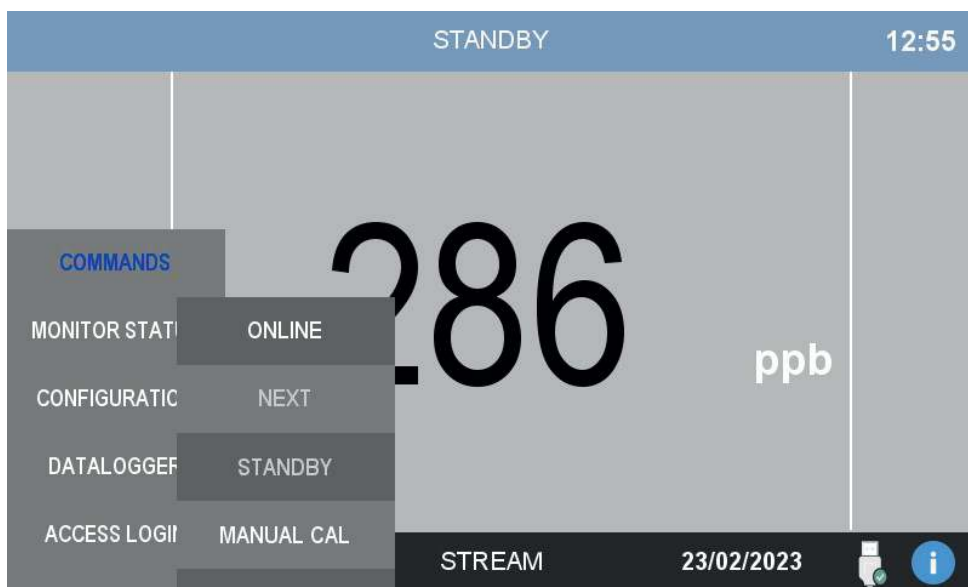

Online

By pressing this button the analyzer will start online analyses.

The ONLINE status is characterized by a dark blue top bar replacing the light blue of the standby mode. In the top bar the word ONLINE also indicates that the instrument is currently in the middle of an analysis run.

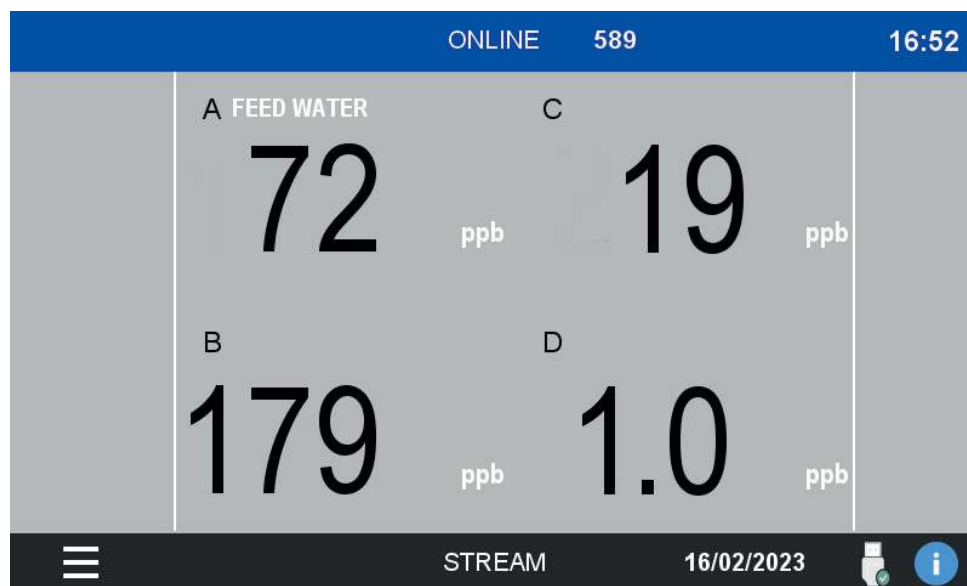

Next

Force switching to next channel. This command is only available if the analyzer is equipped with the automatic switching valve. When pressed the valve will move to the next stream.

Standby

Stop any operation and put the analyzer in the STANDBY status.

Manual cal

Perform the calibration of the instrument. If the calibration value, a calibration error will be raised.

See Section 7 for the correct procedure to perform a calibration.

5.5 Monitor status

This menu contains the data representation in graphical form as well as important diagnostic information on the analyzer status.



Analysis Status

This window will report data on the current analyzer status.

On the left column the user can find the status, the current stream and the time to the next stream switch.

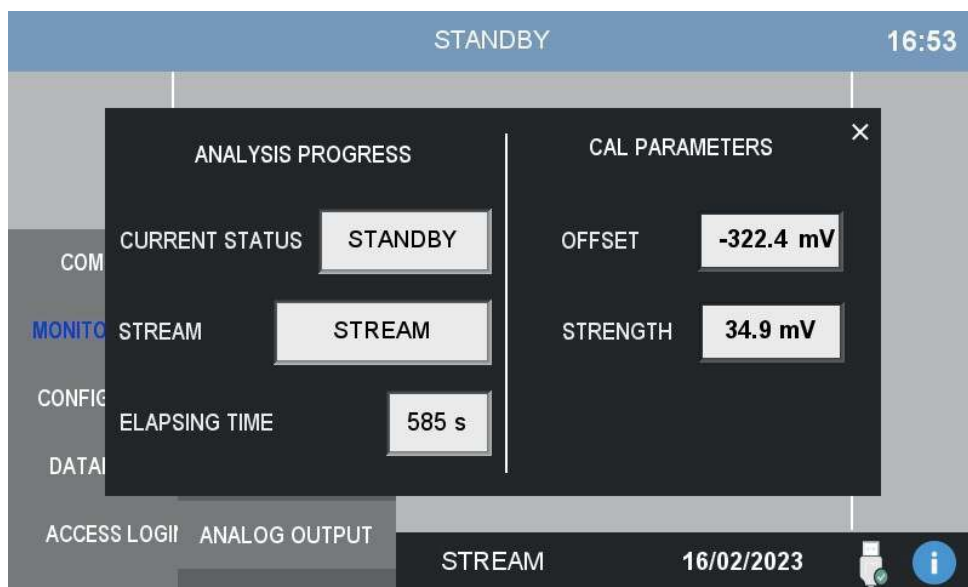

Result trend

This window shows the plot of the most recent analysis results.

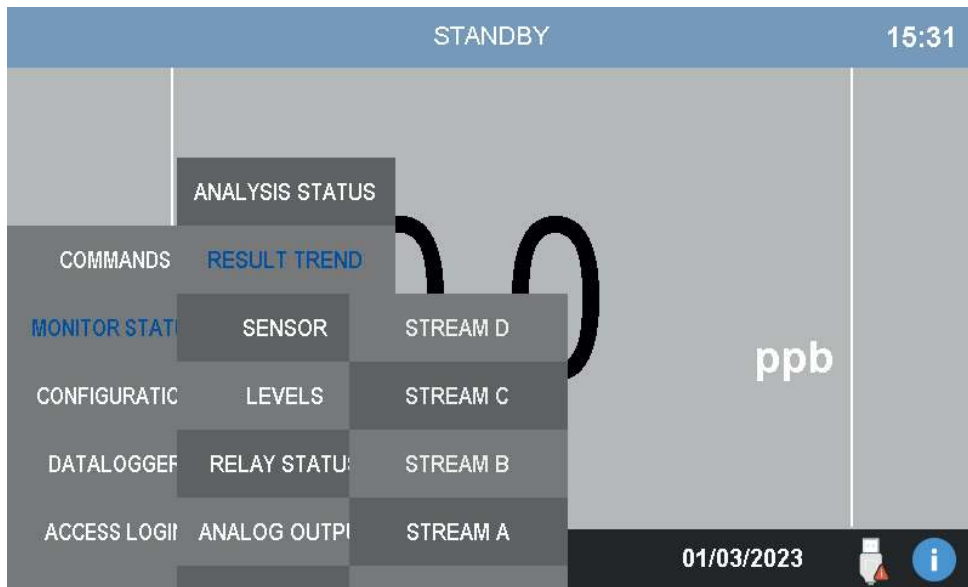

Select one of the available channels to show the results in a graphical form.

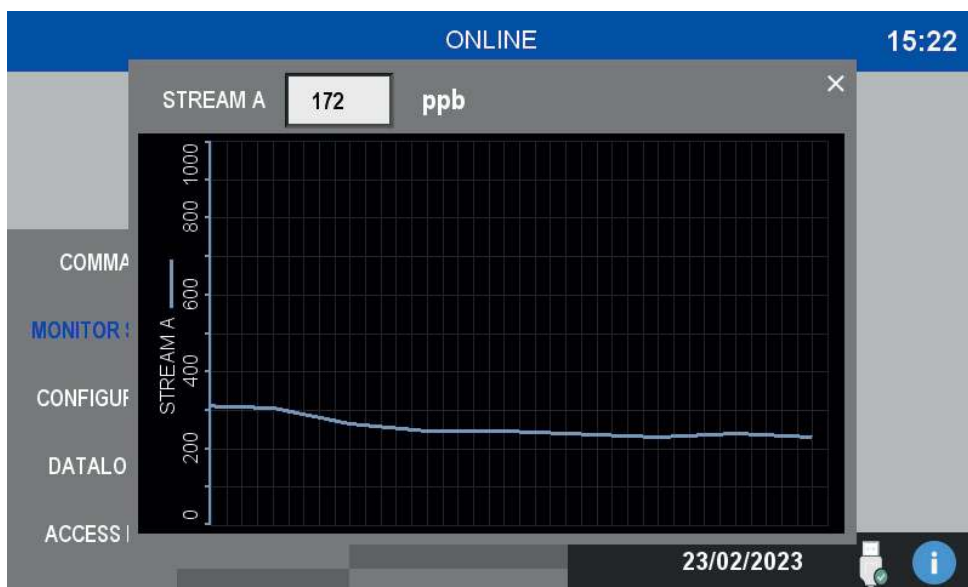

Sensor

This window shows the raw data from the electrode.

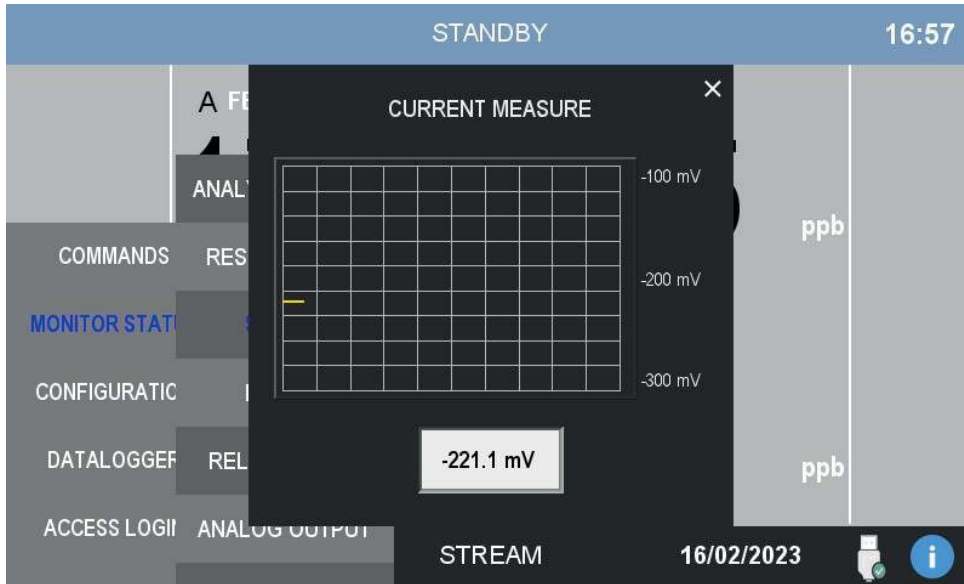

Levels

This window shows the current status of the streams. If a stream is currently missing, this page will show it.

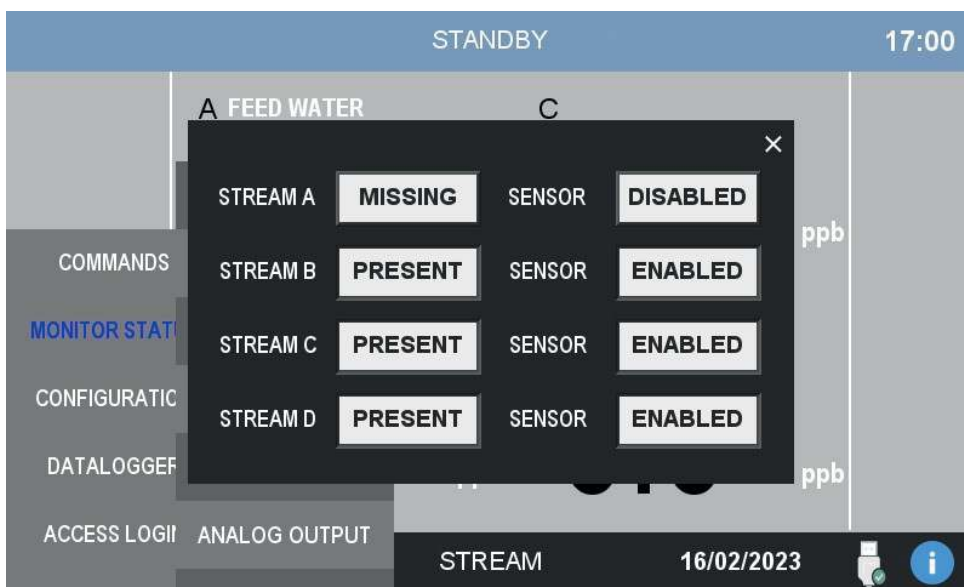

Relays status

The analyzer is provided with four output relays to signal anomalies in the analyzer behavior. Relays can be configured to be activated by various events. See the explanation of the CONFIGURATION menu.

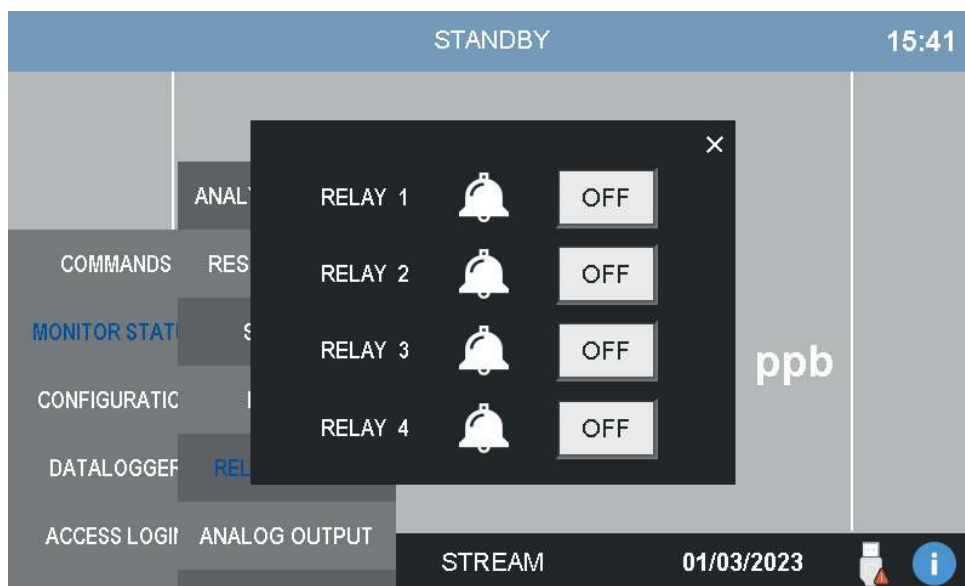

Analog output

The analyzer is provided with four 4-20 mA analog outputs, one for each stream, the current output value can be monitored in this window.

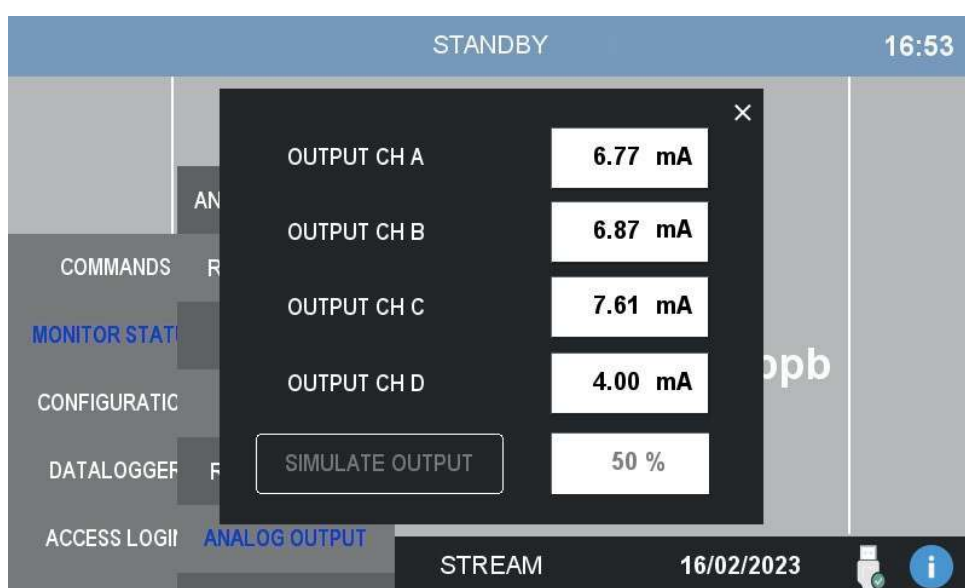

From the same window is also possible to simulate the output, this is useful to test a new installation or for servicing purposes.

To start the simulation press SIMULATE OUTPUT, a numerical pad will appear allowing the user to enter the value as a percentage of the full scale.

Remember to disable the simulation when you have done with it!

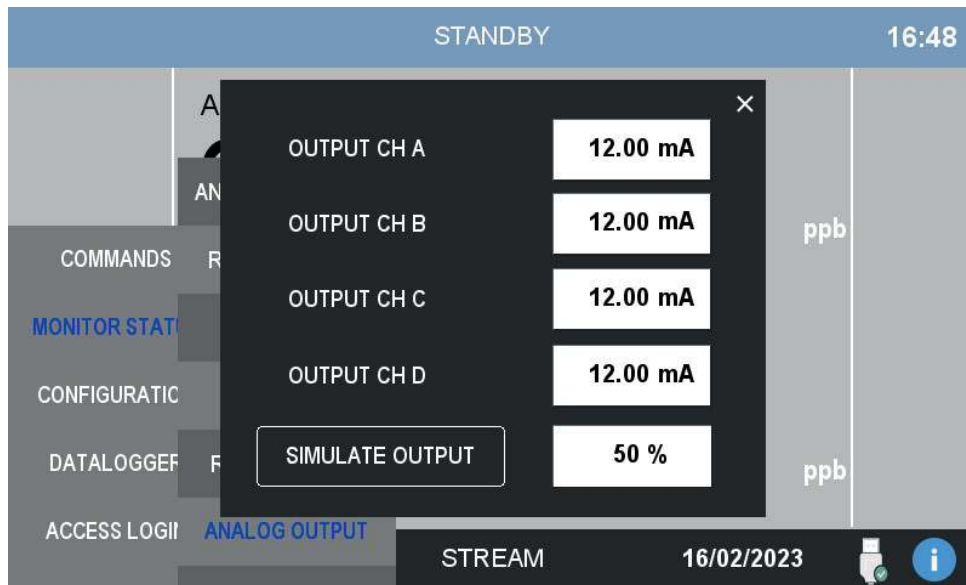

5.6 Configuration

This menu contains the configuration parameters of the analyzer.

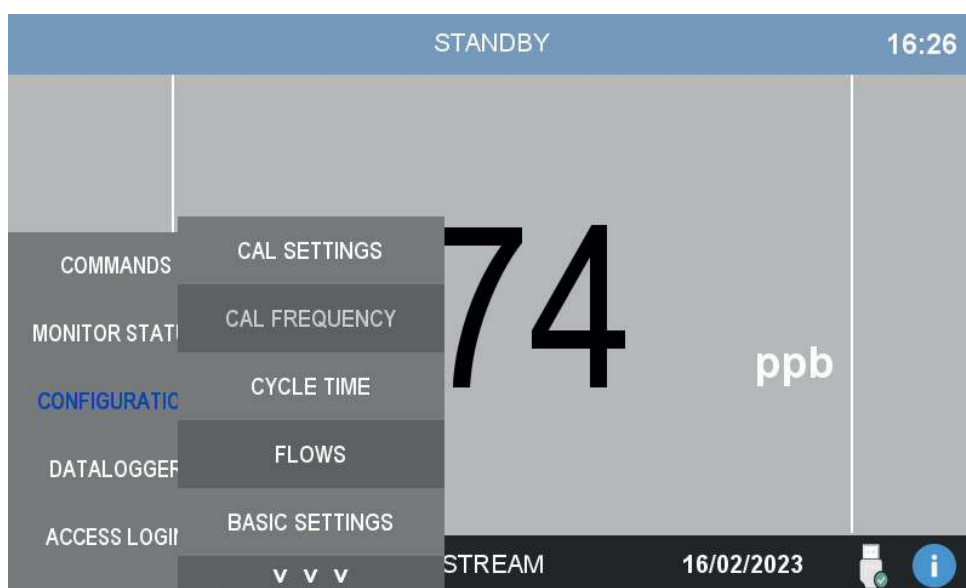

Cal settings

In this page the user can modify the settings for the calibration and specify the concentration of the standard solutions used for the calibration.

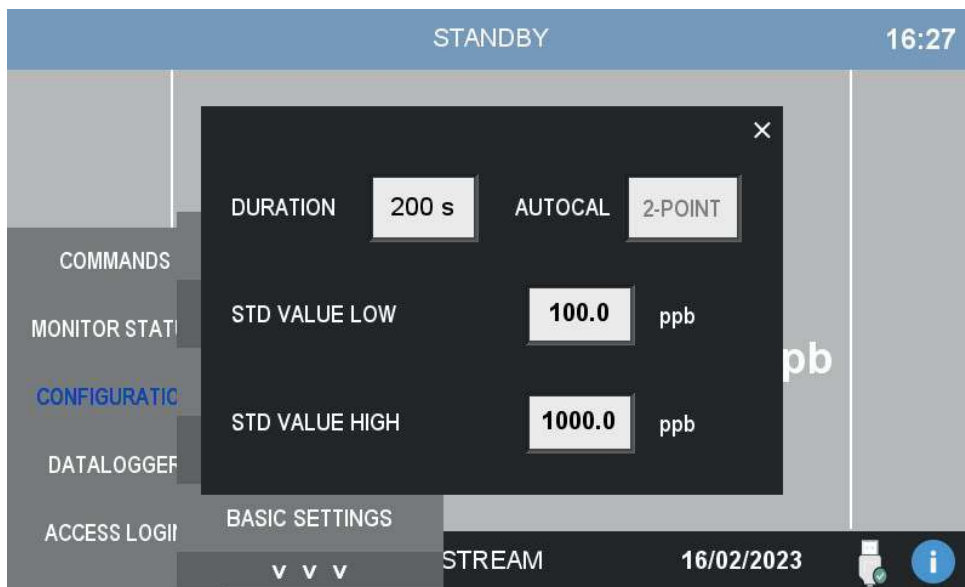

Cal frequency

If the analyzer is equipped with the automatic switching valve is it possible to perform automatic calibrations.

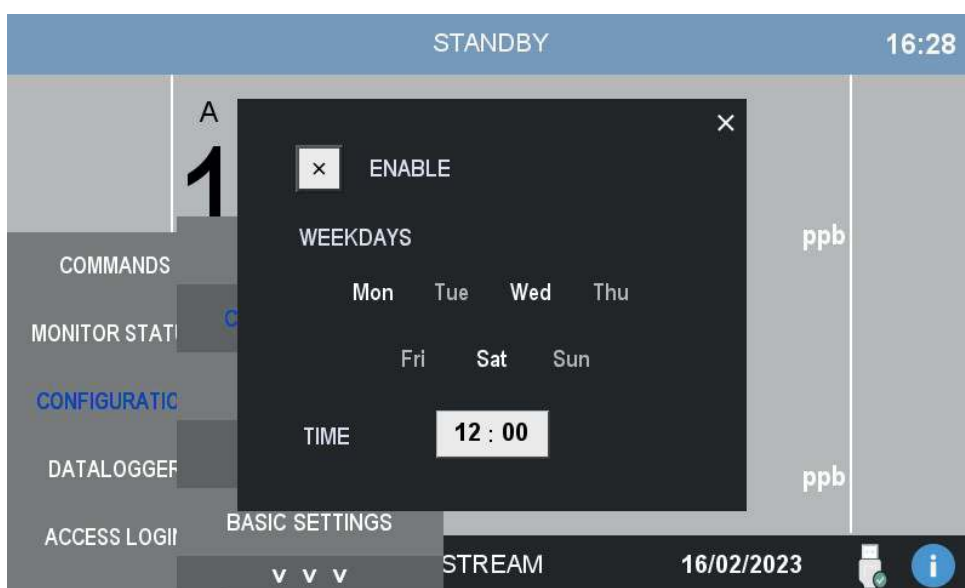

Cycle time

If the analyzer is equipped with the automatic switching valve the user can set the duration of the analysis on each stream.

The conditioning time is a short initialization period before the analysis data is collected and shown. The conditioning period starts before any analysis run or after any stream switching.

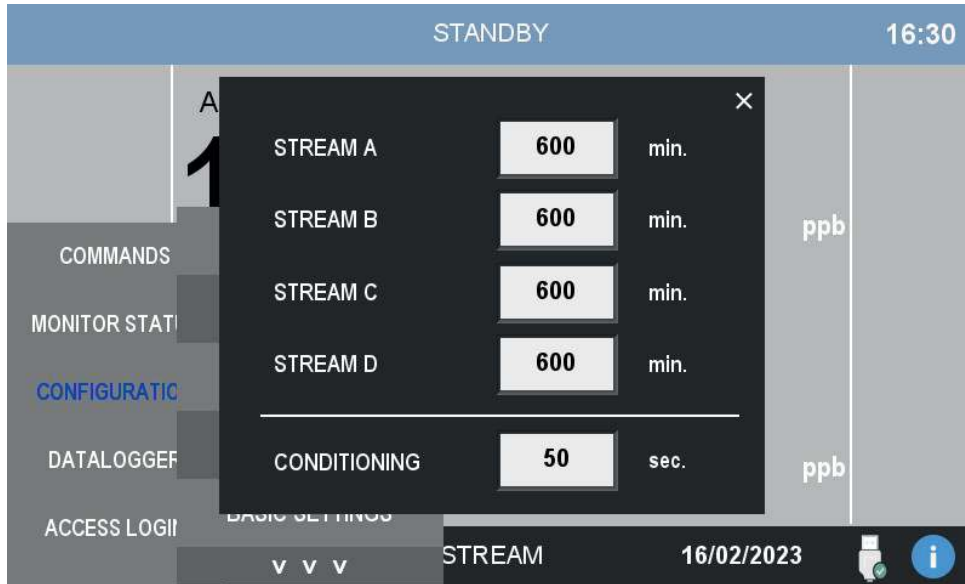

Flows

In this page the user can administer the settings for each stream.

Each individual stream can be disabled independently.

If needed the level sensor can be disabled as well. You will not receive any missing sample alarm from the stream anymore.

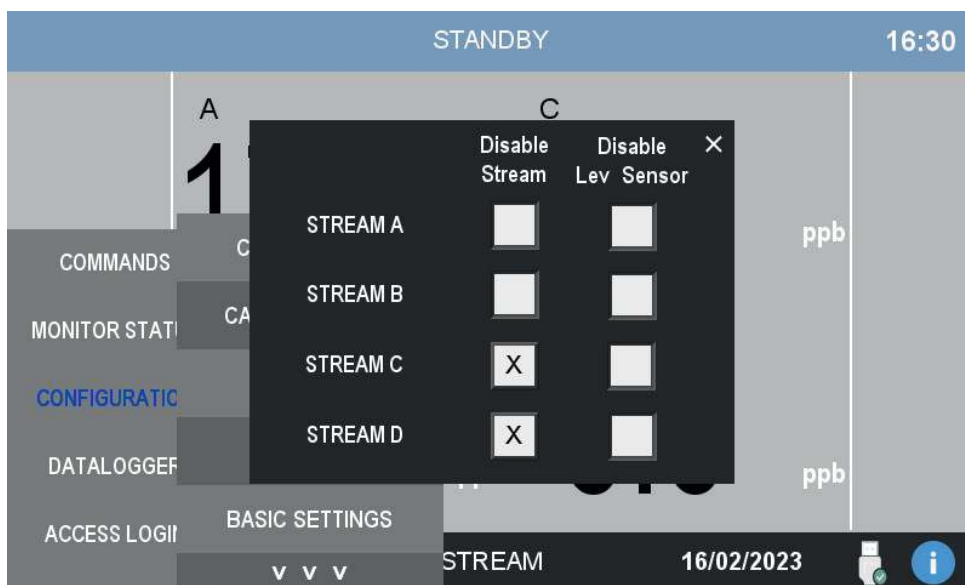

Basic Settings

In this window the user can change some basic settings, like enabling the program update and the backlight switch off.

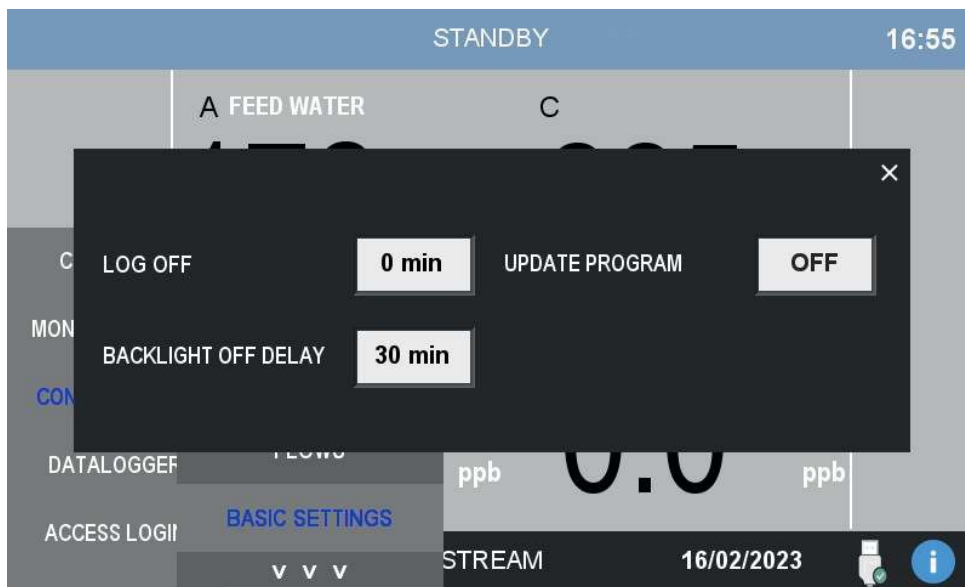

By pressing the arrows at the bottom of the menu you can access a second configuration page:

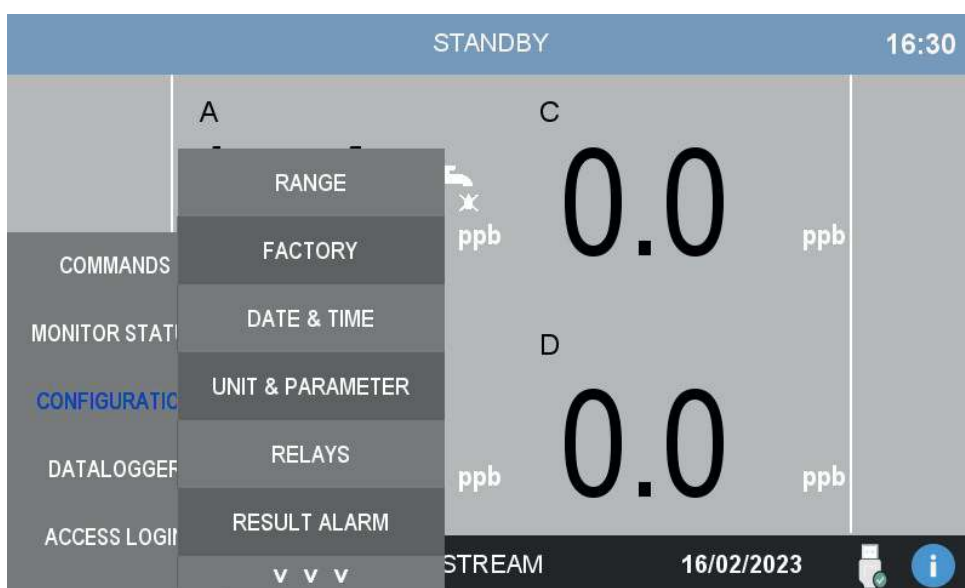

Range

In this window the user can configure the range of the analyzer. The four ranges can be configured independently.

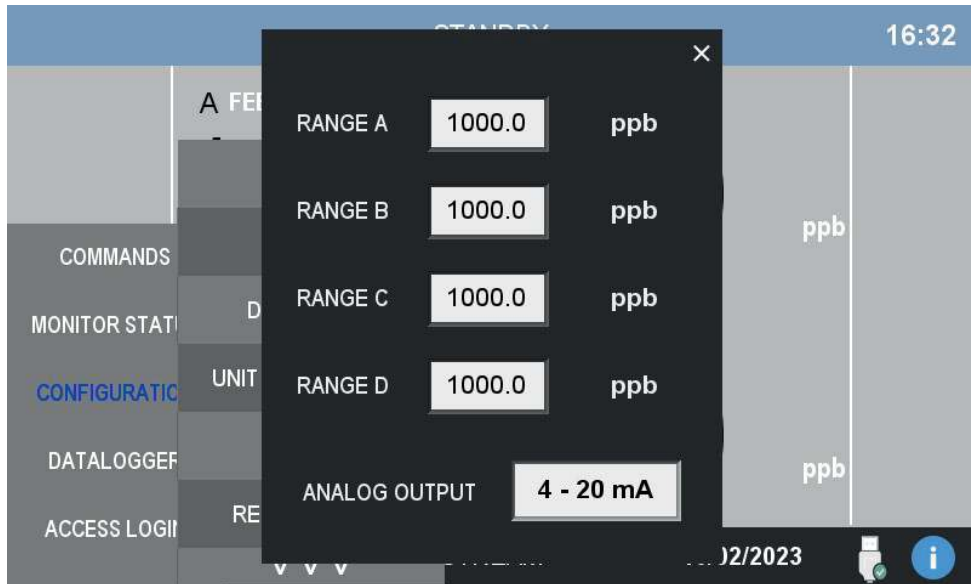

Date & Time

In this window the user can modify the date and the time.



Unit and parameter

In this window you can set new labels for each stream. These labels will be shown on the main page. The measure unit can be set as well.

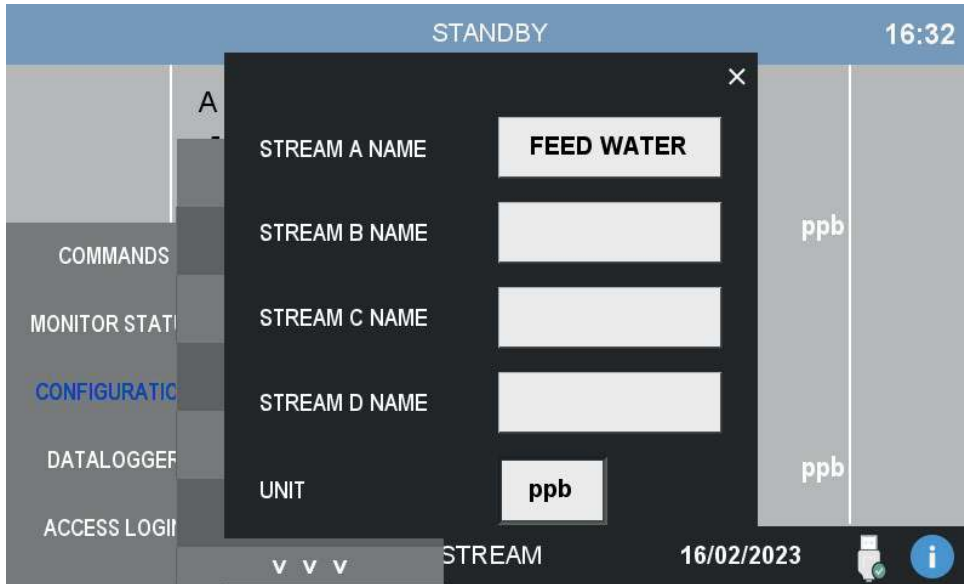

Relays

The user can configure the four relays arbitrarily. Every relay can be bound to an event and be activated consequently. The failsafe mode invert the logic of relays making them on by default and off when the condition is active.

RELAY 1	RELAY 2	RELAY 3	RELAY 4
MISSING SAMPLE A	MISSING SAMPLE A	MISSING SAMPLE A	MISSING SAMPLE A
MISSING SAMPLE B	MISSING SAMPLE B	MISSING SAMPLE B	MISSING SAMPLE B
MISSING SAMPLE C	MISSING SAMPLE C	MISSING SAMPLE C	MISSING SAMPLE C
MISSING SAMPLE D	MISSING SAMPLE D	MISSING SAMPLE D	MISSING SAMPLE D
RESULT ALARM A	RESULT ALARM A	RESULT ALARM A	RESULT ALARM A
RESULT ALARM B	RESULT ALARM B	RESULT ALARM B	RESULT ALARM B
RESULT ALARM C	RESULT ALARM C	RESULT ALARM C	RESULT ALARM C
RESULT ALARM D	RESULT ALARM D	RESULT ALARM D	RESULT ALARM D
ONLINE A	ONLINE A	ONLINE A	ONLINE A
ONLINE B	ONLINE B	ONLINE B	ONLINE B
ONLINE C	ONLINE C	ONLINE C	ONLINE C
ONLINE D	ONLINE D	ONLINE D	ONLINE D
CAL ALARM	CAL ALARM	CAL ALARM	CAL ALARM

RELAYS FAILSAFE MODE OFF

The following events are available:

LOSS OF SAMPLE #	The relay is activated when the level sensor of the recirculating tank indicates the absence of a sample.
RESULT ALARM #	The relay is activated when the last measured value is outside the preset limits. Once the value returns within the limits, the alarm is reset.
ONLINE #	The relay is activated when the corresponding stream is online.
CALIBRATION ALARM	The relay is activated when a calibration falls outside of the limits.

Result Alarm

The analyzer can incur into events that require user attention or user intervention. In this window the user can bind an event either to a warning or to a fault, or even disable the event completely. The warning or fault will be displayed on the screen and communicated externally through one of the two relays. In the case of fault, the analyzer will completely stop every operation until user intervention.

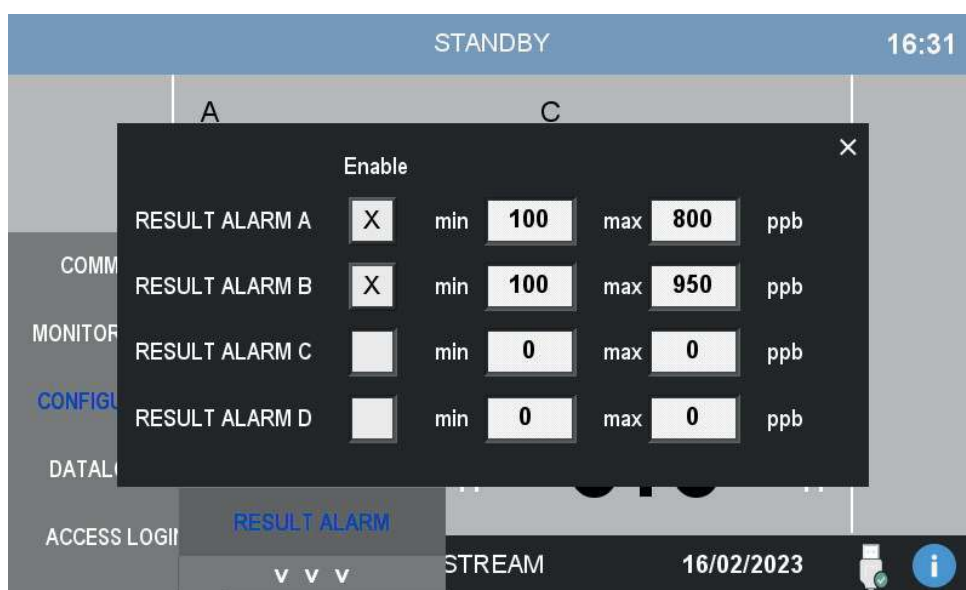

5.7 Other

By clicking on the bottom right corner the page with the version info appear. Use the QR code to download the user manual (this manual).

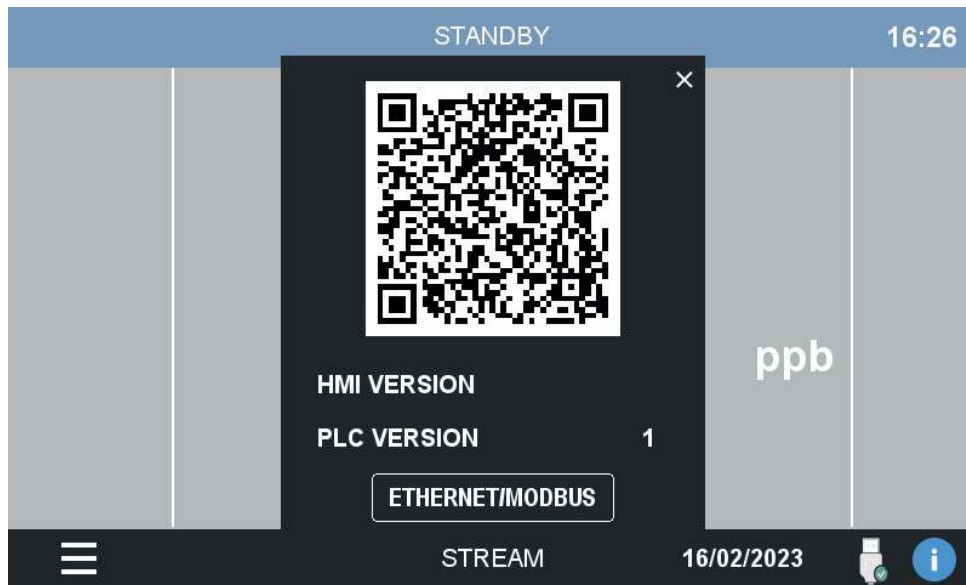

Press the ETHERNET/MODBUS button to show the related settings page as shown below.

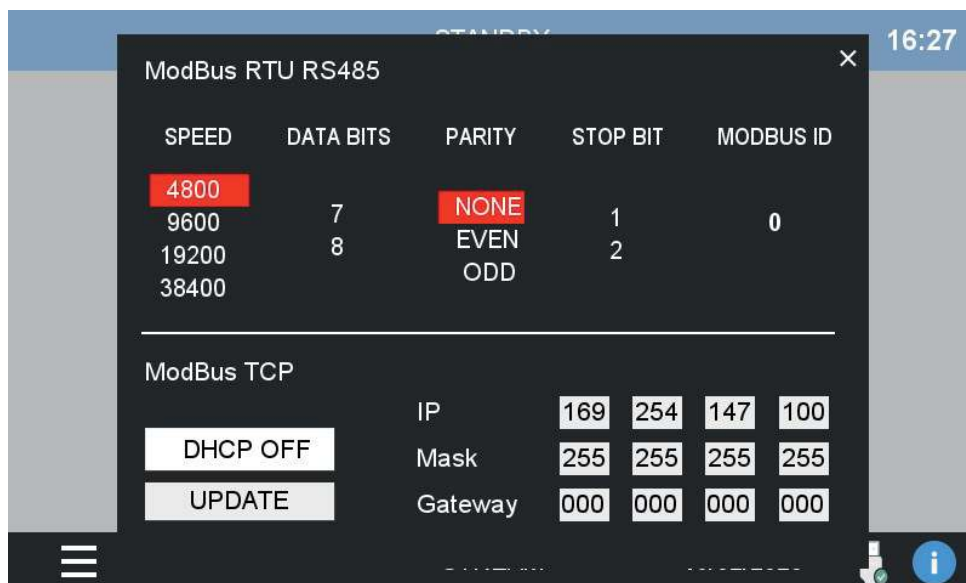

From here you can change the configuration parameter for the Modbus connection. In the upper part you can find the configuration of the connection via RS485, in the bottom part you can set the Ethernet parameters. You are free to set a static IP address or let DHCP decide, in any case remember to press UPDATE after any changes are made.

The commands available for the serial communication are listed in the table in section 3.8.

6 - CALIBRATION

6.1 About the method

To calibrate the analyzer two standard solutions with a known concentration of sodium ions are required. The concentration range of these standards should cover the expected range of sodium concentrations to be measured in the samples.

If your analyzer is equipped with the automatic switching valve (NA6-2 models) the calibration will be fully automatic, you will only need to provide the required standard solutions. In the case of the NA6-1 model, the operator needs to switch standard solution to perform the calibration.

Sodium standard solution can be purchased or prepared by dissolving a known quantity of sodium chloride (NaCl) or other sodium salt in demineralized water.

Periodical calibrations can be carried out using only a single point, in that case only the low value standard solution is used. This is a quick way to keep the calibration up to date while saving time and standard solution. The single point calibration only update the sensor offset while keeping the slope constant.

Two-point calibrations can be carried out sporadically to update both offset and slope.

6.2 Manual calibration (NA6-1)

Before starting make sure the analyzer is in STANDBY. Then rotate the manual switching valve towards the calibration label as shown below.

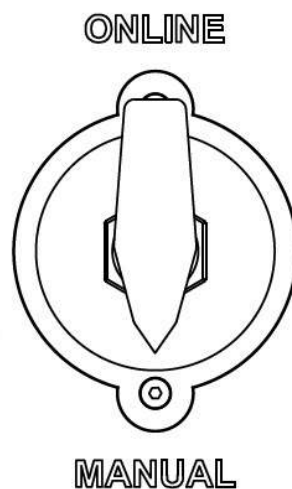

To start a manual calibration prepare the necessary standard solutions and log in with your SERVICE password on the analyzer control panel. Go to COMMANDS menu and press MANUAL CAL, a dialog window appears.

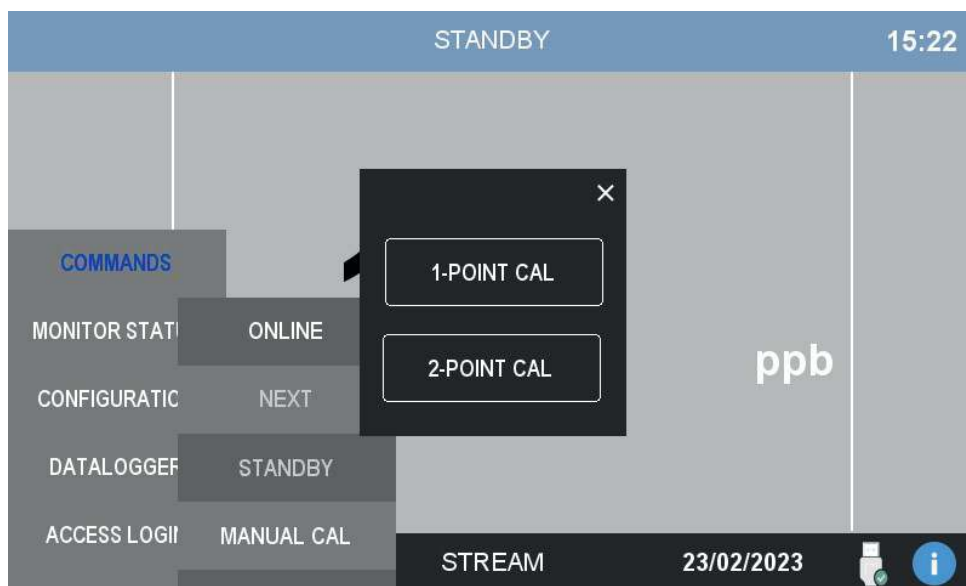

Two-point calibration

Press 2-POINT CAL button to perform the calibration. A second dialog window appears asking the user to provide the first standard solution. The concentration of the required solution is reminded in the dialog. Manually move the straw to the appropriate container.

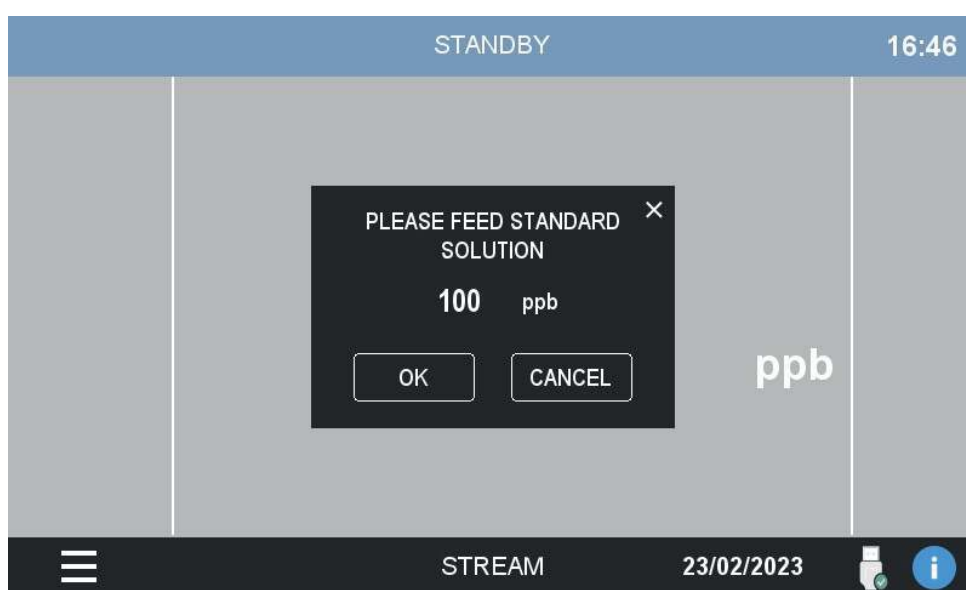

After confirmation, the calibration starts and the following window will be shown for the duration of the operation. If the window is closed before the calibration ends, the operation will be aborted.

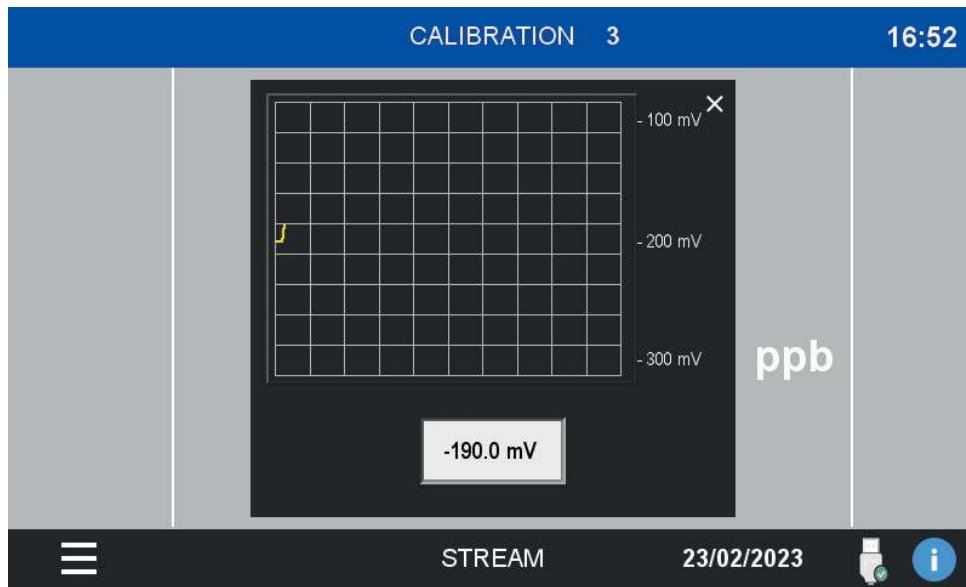

At the end of the countdown, a second dialog appears prompting the user to replace the standard solution.

Manually replace the standard solution with the one with higher value and press OK to continue the calibration.

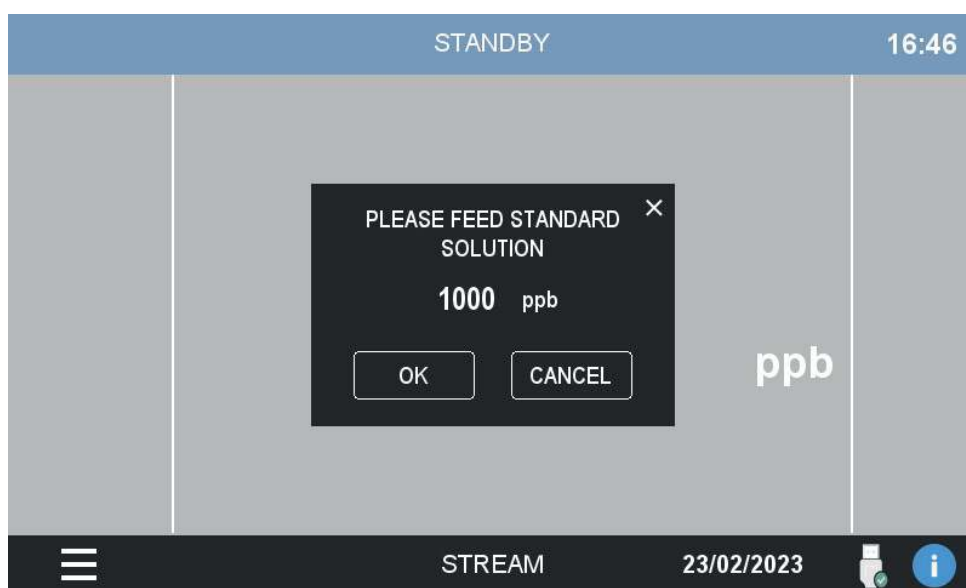

At the end of the countdown the calibration is completed. The outcome of the calibration can be checked in the DATALOGGER > CAL LOG.

One-point calibration

The single point calibration, or standardization, is carried out in the same way, but only the first point will be measured. Press 1-POINT CAL button to start the single point calibration. A second dialog window appears asking the user to provide the first, and only, required standard solution. The concentration of the solution is reminded in the dialog. After confirmation, the calibration window appears like in the two-point calibration.

Remember to restore the ONLINE position of the manual switching valve before starting online operations again.

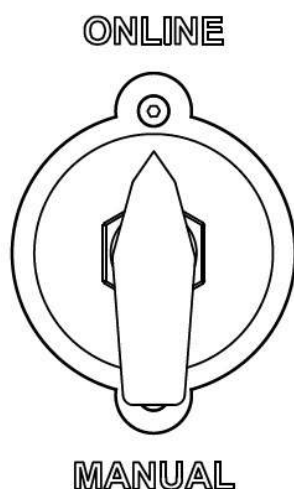

6.3 Manual calibration (NA6-2)

Before starting make sure the analyzer is in STANDBY. Then go to COMMANDS and press MANUAL CAL. The following dialog will be shown.

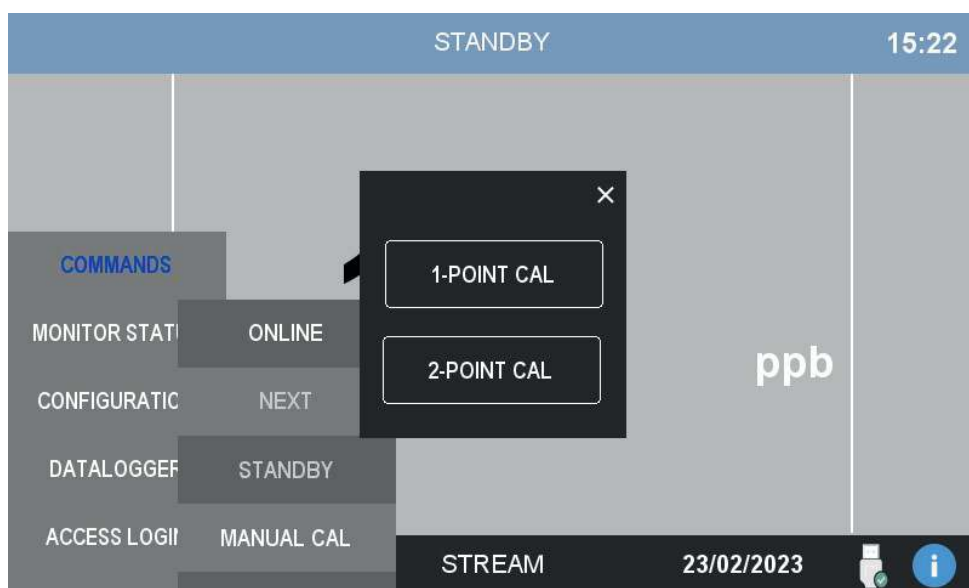

Two-point calibration

Press 2-POINT CAL button to perform the calibration. A second dialog window appears asking the user to prepare the two solutions. The concentration of the required solutions is reminded in the dialog. Since the analyzer is equipped with the automatic switching valve, the user is only required to verify that the solutions are present, freshly prepared and the two straws are correctly positioned in the respective containers.



After confirmation, the calibration starts and the following window will be shown for the duration of the operation. If the window is closed before the calibration ends, the operation will be aborted.

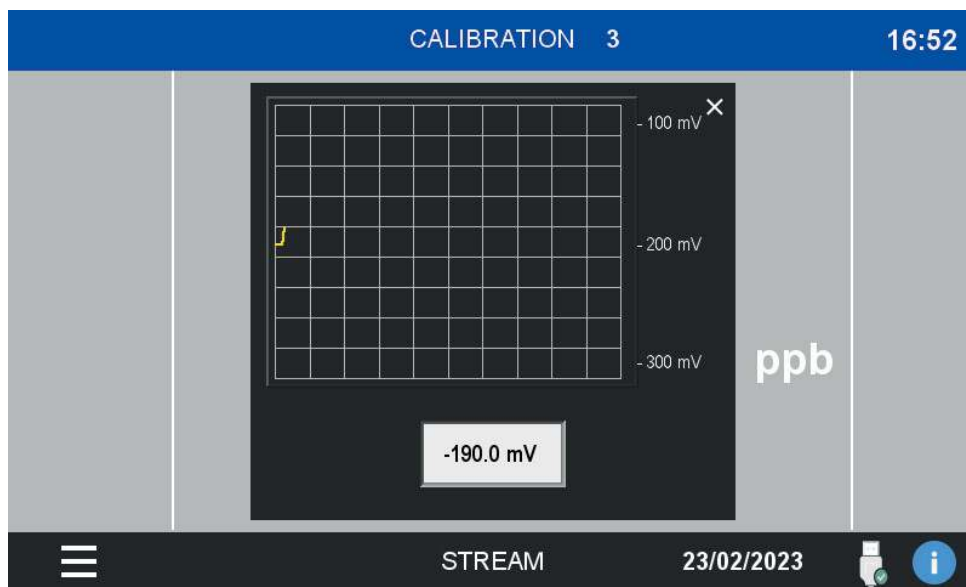

At the end of the countdown, the calibration is complete.

One-point calibration

The single point calibration, or standardization, is carried out in the same way, but only the first point will be measured. Press 1-POINT CAL button to start the single point calibration. A second dialog window appears asking the user to provide the first, and only, required standard solution. The concentration of the solution is reminded in the dialog. After confirmation, the calibration window appears like in the two-point calibration. The automatic switching valve will correctly select the standard solution for the calibration and restore the sample stream at the end of it.

6.4 Autocalibration (NA6-2 only)

The NA6 versions equipped with the automatic switching valve can perform autocalibrations, the operation is fully automatic, no user input required.

Autocalibrations can be scheduled at regular intervals and proceed in the same way as the manual calibration, but without waiting for user confirmation.

The operation starts automatically at the predefined time if the autocal option is enabled and if the analyzer is in the ONLINE status.

If the calibration is successful the analyzer will use the new calibration data immediately. In case of failed calibration (slope of the calibration line is outside of the calibration tolerance) the analyzer will raise an alarm condition. Online analysis will proceed using the old calibration data but the user is invited to verify the electrode condition and replace it if necessary.

In the same way as the other calibration option, autocalibration can be carried out using one or two points.

To schedule autocalibrations, go to CONFIGURATION > CAL FREQUENCY. The user can then select the weekday and time of the operation. Remember to mark the ENABLED checkbox.

7 - DATA STORAGE

7.1 Datalogger Page

The instrument has an integrated datalogger functionality. Every 15 minutes the results are logged together with the time and date of the analysis.

The data is stored on a removable USB device that must be plugged in on the the back of the HMI display. To reach it, open the electronics compartment and look at the bottom of the display. If the storage unit is removed the data is not saved and the datalogger functionality will not be available. A warning will be displayed on the screen the first time the instrument tries to log a result and the device is not present. No further warnings will be raised.

To access the datalogger press DATALOGGER on the main menu of the graphic interface.



Result Data

This is the main datalogger page where the analysis results are shown.

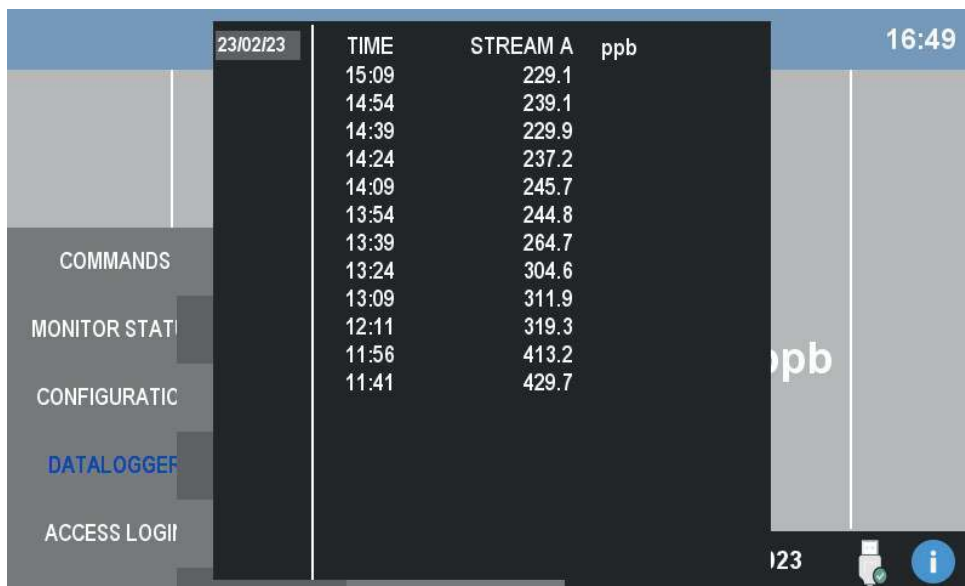

In the leftmost column there are the dates the data has been recorded on. By selecting a day the corresponding lists of measures will be displayed. The time column indicates the analysis time while the other two columns contains the data for the channel.

Alarm Data

In this page the analyzer alarm conditions are collected. The column on the left shows the date, the START column show the time the alarm condition started, the EVENT column describe the alarm. When the alarm condition is resolved the corresponding line will be grayed out and the time will be recorded on the END column.

The data present in the Alarm Data page are stored on the analyzer internal memory and will be recorded even if the external storage is removed.

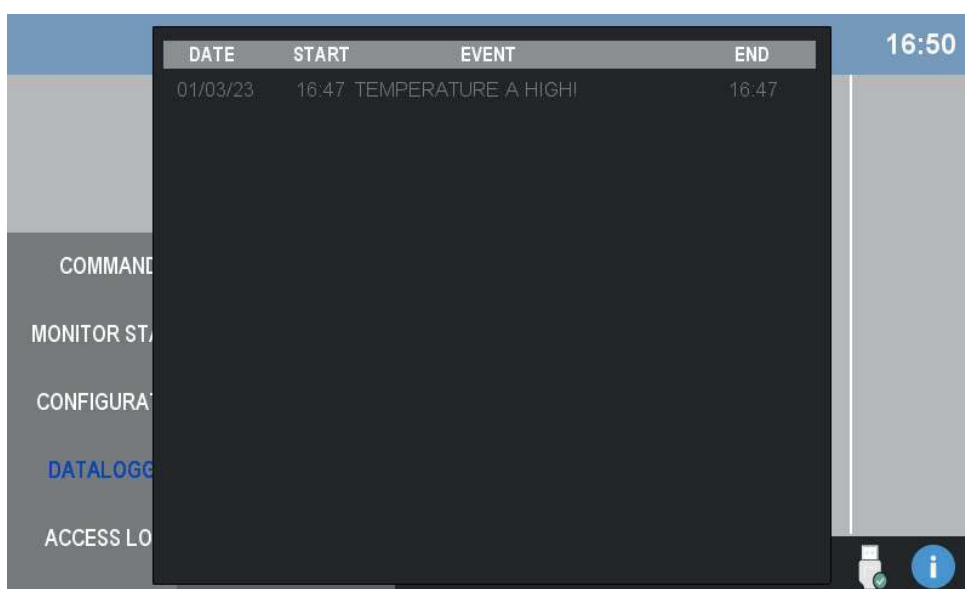

Cal Data

This page collects the data for both failed and successful calibrations.

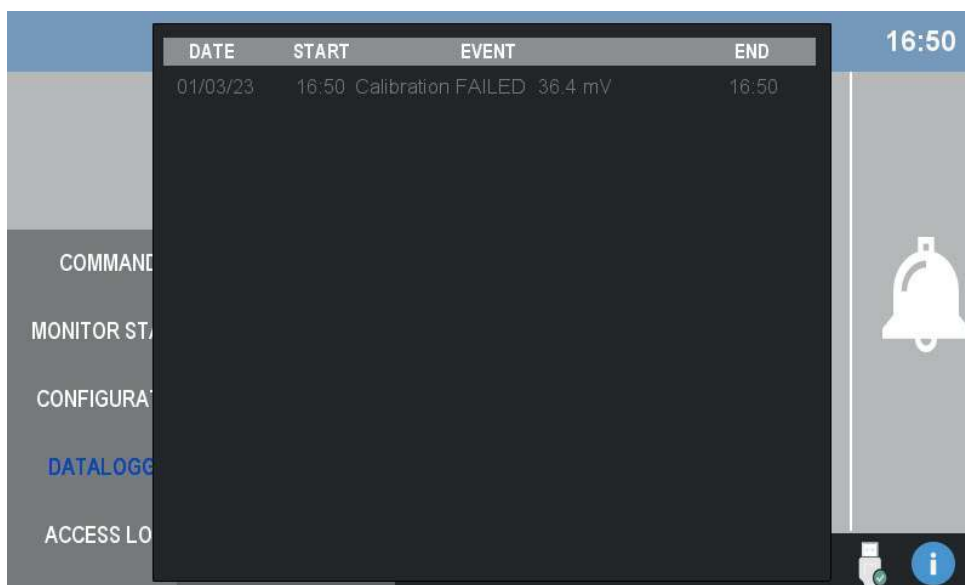

USB

In this page you can clear the data on the external USB device. Is it possible to completely erase the logged data or to selectively erase the data for the current day.

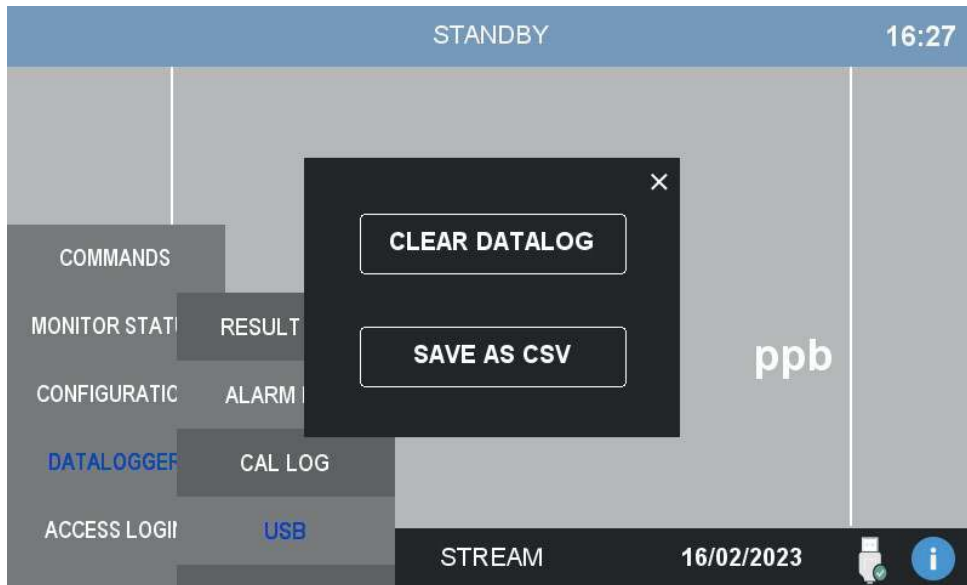

8 - MAINTENANCE

8.1 Maintenance operation

The following procedures are guides to the maintenance of the analyzer. The procedure chosen depends on the particular installation and sample conditions.

WEEKLY MAINTENANCE

If the analyzer is continuously running at high concentration, greater than 100 ppb, a weekly single point calibration is recommended.

MONTHLY MAINTENANCE

- Replace the bottle of reagent buffer solution. The level of solution should not be allowed to fall below about one quarter of the bottle. On high ambient temperature installation and for low sodium concentration, the solution may require replacement more frequently.

- It is recommended to calibrate once a month. When the sodium concentration is above 1 ppb, carry out a 2-point Calibration.

When the sodium concentration is below 1 ppb, an electrode regeneration should be carried out before a 2-point Calibration.

TWICE A YEAR replace pump tubing

Important: replace pump tubing, use only spare parts provided by the manufacturer to ensure proper sealing.

8.2 pH adjuster solution replacement

Two alternative reagent solution may be used, depending on the required lower limit of measurement. Concentrated ammonia solution, which provides adjustment of sample pH to 10.7 for measurement of sodium ion to approximately 0.5 ppb

At concentration below 0.5 ppb, hydrogen ion interference becomes significant and a reagent of diisopropylamine solution should be used. This adjust the sample pH to 11.2 - 11.5 and enables measurement below 0.5 ppb.



Concentrated ammonia solution - 1 l

Use directly 28-30 % w/v solution.

This buffer should be handled very carefully. Bring the reagent bottle out of the analyzer wearing gloves and eye protection, and refill it under a fume hood.



Diisopropylamine solution - 1 l

Use directly 99% solution.

This buffer should be handled very carefully. Bring the reagent bottle out of the analyzer wearing gloves and eye protection, and refill it under a fume hood. The following points should be also noted:

- Diisopropylamine is extremely inflammable and irritating colorless liquid with a strong smell of ammonia
- In the event of fire, extinguish with water spray, foam, dry powder or carbon dioxide
- If a spill occurs, shut off all possible source of ignition and instruct others to keep a safe distance. Mop up spill with plenty of water, diluting greatly. Ventilate the area well to evaporate any remaining liquid and dispel vapor.



8.3 Influence of pH on the measure

Measuring the pH of the effluent from the flowcell indicates adequate buffering. The minimum pH depends on the minimum sodium concentration, but the pH value is calculated as:

pH must be greater than $-pNa^+ + 3$, so ideally:

100 ppb Na^+ = pH must be greater than 8.4

10 ppb Na^+ = pH must be greater than 9.4

1 ppb Na^+ = pH must be greater than 10.4

0.5 ppb Na^+ = pH must be greater than 11.4

Important: if the buffer is allowed to become completely exhausted, the reading may be very erratic due to the lack of pH adjustment.

8.4 Preparing standard solution

The following instructions refer to the preparation of 100 ppb and 1 ppm sodium, LOW and HIGH standard solutions respectively, but any concentration can be prepared within the measuring range selected by appropriate dilution of the stock solution.

Dissolve 2.543 (± 0.001) gr of analytical grade sodium chloride in approximately 100 ml high purity water.

Transfer this solution into a one liter volumetric flask and make up the 1 liter mark with more high purity to give a stock solution of 1000 ppm sodium ions. Store in a plastic container.

Pipette 10 ml of this solution to one liter volumetric flask. Make up to the 1 liter mark with high purity water to give a solution of 10 ppm sodium ions.

Pipette 20 ml of the 10 ppm solution into a two liter volumetric flask and make up to the 2 l mark with high purity water to give the LOW standard solution of 100 ppb sodium ions.

Transfer this solution into the container on top of the analyzer labeled Low Standard Solution.

Pipette 200 ml of the 10 ppm solution into a two liter volumetric flask and make up to the 2 l mark with high purity water to give the HIGH standard solution of 1 ppm (1000 ppb) sodium ions.

Transfer this solution into the container on top of the analyzer labeled High Standard Solution.

- Do not prepare static sodium solution of less than 50 ppb because low concentration solution rapidly become contaminated and change in concentration.
- Although the HIGH and LOW standard solutions are typically one decade apart in sodium concentration, any concentration difference can be used within the constraints of above and the need to have a significant change in electrode output to achieve an accurate calibration.

NOTE: that High purity water is water containing less than 2 ppb sodium ions and a specific conductivity of less than approximately 0.2 $\mu\text{S}/\text{cm}$.

8.5 Electrode rinse solution

The electrode can be rinsed with a dilute alkaline solution. To prepare this solution weight out 0.2 g of calcium hydroxide, Ca(OH)_2 , and dissolve it in 1 l demineralized water.

This solution can be used to rinse the electrode between measurements and as electrode storage solution.

8.6 Shutdown procedure (prolonged shutdown, 1+ months)

1. Remove the buffer solution bottle and safely dispose of the content. Rinse the container thoroughly.
2. Place the standard solution straw(s) in a container full of demineralized water. Start a 2-point calibration to flush the system. The calibration will fail, if this is a problem for you, abort the calibration before its end.
3. Remove the electrode, rinse it with the electrode rinsing solution and cover the tip with the protective cap provided with it.
4. Switch off the analyzer (the switch button is located in the upper case)

8.7 Troubleshooting

CONDITION	CAUSE	SOLUTION
CALIBRATION FAIL	A calibration fail condition will occur after a 2-point calibration if the electrode response does not meet the requirements. This happens when the electrode "strength" (slope) is below the threshold	<ul style="list-style-type: none"> • Make sure that standard solution containers are not empty • Check the vapor bubbles are emerging from the bottom of the stainless steel entrainment tube • Regenerate the electrode (see monthly maintenance) • If the slope is not improved after the regeneration, the electrode may need to be replaced • Check the system for leakings
NO FLOW	Sample is not flowing correctly through the ricirculation vessel	Check the sample flow
SENSOR HOT	Sample temperature exceeds 55°C	Check the sample condition, protect the electrode from long time operation at high temperature
RESULT ALARM	The measurement falls out of the defined threshold.	See the Alarms section.

8.8 Electronics checks

When the metal cover is opened by removing the five screws it's possible to check a few indicator LEDs, as show below.



After removing the cover, do not touch the device with your hands or tools without removing power! Switching on without the cover is only allowed for visual inspection.

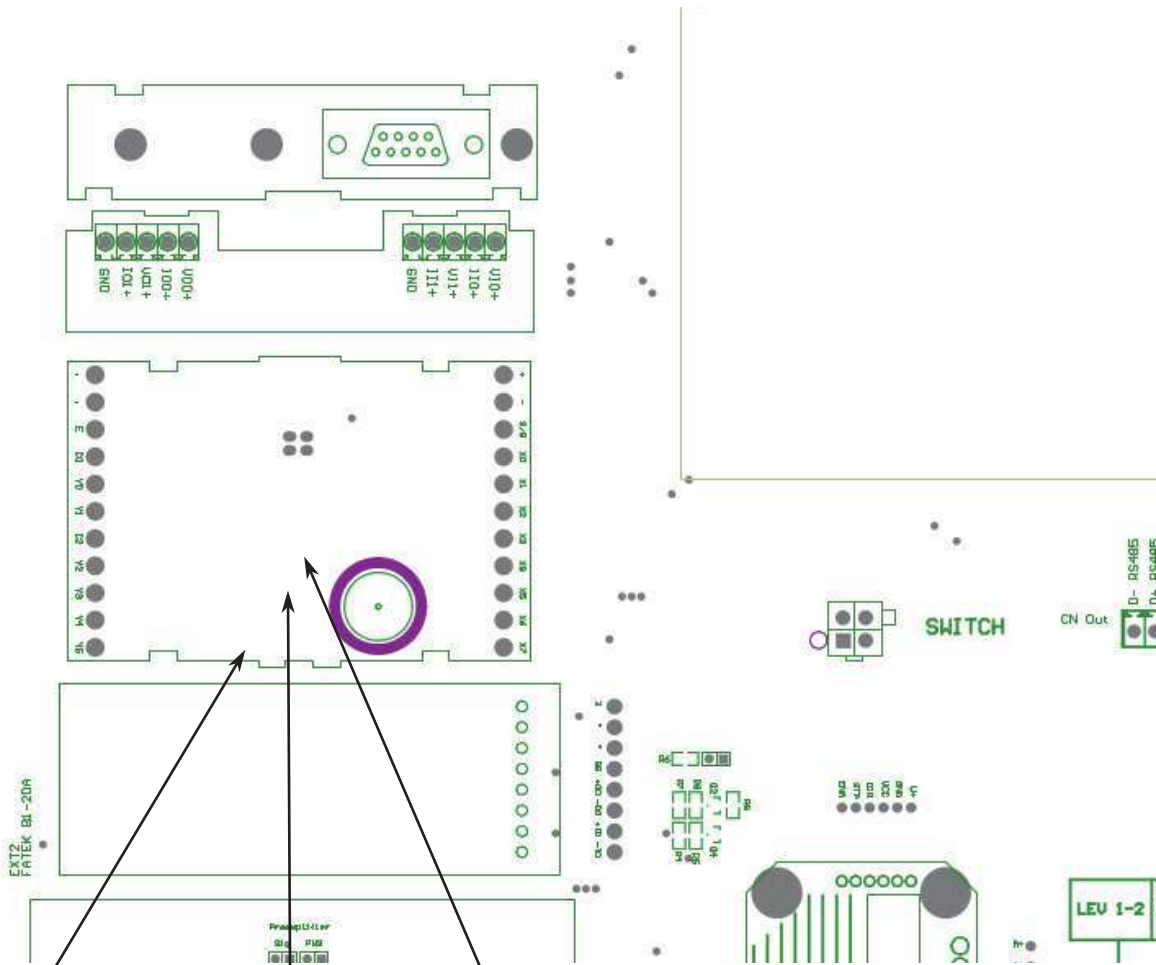

Red LED POWER
always lit

Green RUN LED
blinking rapidly

green LED and red LED alternate
and fast blinking showing the
serial communication with the
touchscreen panel