

INSTRUCTION MANUAL

MODEL HP80 HYDROGEN PEROXIDE ANALYZER



SCREEN MAP

CAL (Calibration)	Auto	Cal 1 (Offset) using Calibration Solution			
		Cal 2 (Slope) using Calibration Solution			
	Standardize	Enter Grab Sample Determined Value			
	Manual	Enter Offset, the PV value and associated mV			
		Enter Slope, mV/pH, mV/decade, mV/ppm...			
Temp	Enter measured Temperature				
CONFIG (Configuration)	XMTR	LCD	Set Up	Temp. Format	°C or °F
				Contrast	Adj. 0-100%
				Back Light	Enter ON time
				Range Lock	Choose: Auto, ppb, ppm, ppT
			Graph	Line	Screen Duration
		Gauge			
		Label	Bar		
			TAG ID	Enter Name	
			TAG	ON/OFF	
			POP UP	ON/OFF	
		Output	4-20 mA (1 or 2)	Range (PV or Temp.)	4 mA =
					20 mA =
				More → CAL	Trim 4.00 mA
					Trim 20.00 mA
				More → Fault	3.5 mA
			22 mA		
			NONE		
	RELAY		Relay 1	Alarm	Set Point
				Timed	Period, Duration
				Fault	
	Relay 2	Alarm	Set Point		
		Timed	Period, Duration		
		Fault			
	Relay 3	Alarm	Set Point		
		Timed	Period, Duration		
		Fault			
	HOLD	Time out: None, 15 min, 30 min...			
	Serial	Address			
		Baud rate			
		Format			
Password	Menu	Off/On " _ _ _ _ "			
	CAL	Off/On " _ _ _ _ "			
	CNFG	Off/On " _ _ _ _ "			
	SIM	Off/On " _ _ _ _ "			
Sensor	Sensor 1 or 2	Type	Choose Type: pH, Cond, ORP.....		
		T COMP	Enter % Comp		
		ISO PT	Enter mV value		
	Qty of Sensors	Choose 1 sensor or 2 sensors			
	COMP	Dissociation, Interference, Percentage, OFF			
Load Default	Sensor/Transmitter	Yes/No			
DAMP or MORE		Enter Signal Dampening (# of readings to average, 0-100)			
OFFSET (DC80 only)		Enter Offset value			
INFO (Information)	XMTR	Configuration, Serial #, Name, Outputs			
	Sensor	Calibration logs, Serial #, Name			
SIM (Simulate)	System	Sensor 1 or 2	Fixed value		
			Ramp		
	Relays	#1 ON/OFF			
		#2 ON/OFF			
		#3 ON/OFF			
	4-20 mA	4-20 mA Ch 1	Enter Value		
4-20 mA Ch 2		Enter Value			

PREFACE





Purchasing products from Electro-Chemical Devices, Inc. provides you with the finest liquid analytical instrumentation available. If this is your first purchase from ECD, please read the entire manual before installing and commissioning your new equipment.

Manuals are accessible on the ECD website at <http://www.ecdi.com/literature/manuals.html> .

If there are any questions concerning this equipment, please contact your local ECD representative, or the factory directly at:

Electro-Chemical Devices, Inc.
1500 North Kellogg Drive
Anaheim, CA 92807 USA
Telephone: +1-714-695-0051
FAX: +1-714-695-0057
Website: www.ECDanalytical.com
Email: sales@ecdi.com

SYMBOLS USED IN MANUAL

	This symbol is used to designate important information, warnings and cautions. Failure to follow this information could lead to harm to the instrument or user.
	No operator serviceable parts, service by authorized service personnel only.
	This symbol is used to designate a WARNING "Risk of Electrical Shock"
	Disconnect supply before servicing
	Equipment protected throughout by double insulation.

	Read the complete manual before installing or using the equipment.
--	--

Contents of this manual are believed to be correct at the time of printing and are subject to change without notice. ECD is not responsible for damage to the instrument, poor performance of the instrument or losses resulting from such, if the problems are caused by:

- Incorrect operation by the user.
- Use of the instrument in incorrect applications.
- Use of the instrument in an inappropriate environment or incorrect utility program (power supply).
- Repair or modification of the related instrument by anyone not authorized by ECD.
- There are no operator accessible parts. Service and maintenance to be done by authorized personnel only.
- If the equipment is used in a manner not specified by the manufacturer, the protection provided by the equipment may be impaired.

© 2014 - 2018 Electro-Chemical Devices, Inc. All rights reserved. No part of this manual may be used or reproduced in any form or by any means, or stored in a database or retrieval system without prior written permission from Electro-Chemical Devices, Inc. Making copies of any part of this manual for any purpose other than personal use is a violation of United States copyright laws. Document printed in the United States of America.

Table of Contents

Screen Map.....	2
TERMS AND CONDITIONS OF SALE.....	9
RETURN GOODS POLICY	10
UNPACKING THE INSTRUMENT	11
INSTRUCTION MANUAL REVISION.....	11
1.0 GENERAL DESCRIPTION	12
1.1 FEATURES	13
1.2 SPECIFICATIONS.....	13
1.2.1 Sensors and Flow Train.....	13
1.2.2 HP80 Analyzer.....	14
1.3 Model Codes.....	15
2.0 INSTALLATION.....	16
2.1 MOUNTING.....	16
2.2 WIRING	17
2.2.1 Wiring, power	17
2.2.2 Wiring, Sensor	18
2.2.3 Wiring, 4-20 mA Outputs.....	18
2.2.4 Wiring, Contact Relay Outputs	18
2.2.5 Wiring, Serial Output MODBUS RTU	18
2.3 INSTALLING the SENSORS.....	19
2.4 PLUMBING	19
2.4.1 Sample Requirements	19
2.4.2 Connecting the Inlet and Drain fittings	19
2.4.3 Adjusting the Sample Flow Rate.....	20
2.5 Connecting the Optional Spray Cleaner	20
3.0 OPERATION.....	21
3.01 Influences on the Measurement	21
pH Value	21
3.02 Influences on the Measurement	21
Flow	21
3.03 Influences on the Measurement	21

Temperature.....	21
3.1 KEYS	22
3.1.1 Home/Exit Key	22
3.1.2 Back/Hold Key.....	22
3.1.3 Selection Adjustment Keys	22
3.1.4 Alpha Numeric Entry.....	24
3.2 MENU STRUCTURE	24
3.2.1 HOLD (Output Hold)	24
3.2.2 CAL (Calibration Menu)	24
3.2.3 CONFIG (Configuration Menu)	25
3.2.4 INFO (Information Menu).....	26
3.2.5 SIM (Simulation Menu).....	27
3.2.6 Fault Screens.....	27
3.3 OUTPUT CONFIGURATION GUIDE	27
3.3.1 Configure 4-20 mA output range.....	28
3.3.2 Configure 4-20 mA Fault Condition and Cal	28
3.3.3 Configure Alarm Relays (Relays Optional).....	28
3.3.4 Exit Menus and Return to Main Display	29
3.3.5 Sensor Start Up.....	29
3.4 USER SELECTABLE OPTIONS	29
3.4.1 Screen Lighting	29
3.4.3 Graphical display	30
3.4.4 TAG Transmitter Name.....	30
3.4.5 Sensor Name.....	30
3.4.6 Password Protection.....	31
4.0 CALIBRATION	32
4.0.1 AUTO Calibration description	32
4.0.2 STANDardize Calibration description	32
4.0.3 MANUAL Calibration description.....	33
4.1 pH Calibration Procedures.....	34
4.1.1 AUTO Cal using pH 4.01, 7.00, 10.00 buffers	34
4.1.2 AUTO Cal using other pH buffers.....	34
4.1.3 Standardize	34

4.2 Hydrogen Peroxide Calibration Procedures	35
4.2.1 Auto Cal	35
4.2.2 Standardize	36
4.2.3 Manual Cal	36
5.0 MAINTENANCE	37
5.1 Hydrogen Peroxide Sensor	37
5.2 pH Sensor.....	38
5.2.1 Electrode Cartridge Installation.....	38
5.2.2 Electrode Cartridge Replacement	38
5.2.3 Electrode Cleaning.....	38
5.2.4 pH Electrode Cartridge Cleaning	39
5.3 Constant Head Flow Controller (CHFC)	39
6.0 TROUBLESHOOTING	40
7.0 PARTS AND ACCESSORIES	42
7.1 HP80 Replacement parts	42
7.2 T80 Front Panel Control Board Exploded	43
7.3 T80 Front Panel Control Board Exploded, with Relays.....	43
7.4 T80 Transmitter Case, back with Cable Glands	44
7.5 T80 Replacement Parts.....	44
APPENDIX	45
A. Auto Cal Buffer Tables.....	45
B. MODBUS RTU Register Listing.....	45
03 (0x03) Read Holding Registers.....	45
06 (0x06) Write Single Register	46
Registers	46
Fault Status.....	50
Warning Status	50
Sensor Type	50
C. Auto Spray Cleaner	52

TERMS AND CONDITIONS OF SALE

1. **ACCEPTANCE.** If this writing differs in any way from the terms and conditions of Buyer's order or if this writing is construed as an acceptance or as a confirmation acting as an acceptance, then Seller's acceptance is **EXPRESSLY MADE CONDITIONAL ON BUYER'S ASSENT TO ANY TERMS AND CONDITIONS CONTAINED HEREIN THAT ARE DIFFERENT FROM OR ADDITIONAL TO THOSE CONTAINED IN BUYER'S WRITING.** Further, this writing shall be deemed notice of objection to such terms and conditions of Buyer. If this writing is construed as the offer, acceptance hereof is **EXPRESSLY LIMITED TO THE TERMS AND CONDITIONS CONTAINED HEREIN.** In any event, Buyer's acceptance of the goods shall manifest Buyer's assent to Seller's terms and conditions. No addition to or modification of these terms will be effective, unless set forth in writing and agreed to by Seller.
2. **WARRANTIES AND REMEDIES**
 - a. **Warranty.** Seller warrants to Buyer that it holds and will HPSs marketable title to the goods sold hereunder. Seller warrants to Buyer that the items and components manufactured by Seller will be free from defects in material and workmanship (subject, however, to tolerances and variances permitted by the trade hereunder) for a period one (1) year for non-consumable products. Consumable electrodes and sensors have a conditional warranty based shelf life and process conditions and is determined by Seller.
 - b. **Exclusion and Conditions.** Seller's obligations with respect to the express warranties and remedies contained herein are conditioned on the following: (i) Buyer's return of the non-conforming goods, if authorized by Seller; (ii) Buyer shall not assign its rights under these express warranties and any attempted assignment shall render such warranties, but not any disclaimers or limitations, void and the goods sold shall be sold **AS IS**; and (iii) all products shall be carefully inspected for damage by Buyer upon receipt, be properly calibrated for Buyer's particular use, and be used, repaired, and maintained by Buyer in accordance with the instructions set forth in Seller's product literature. Repair and maintenance by non-qualified personnel, product subjected to misuse or negligence, and/or damaged during shipment will invalidate the warranty, as will the use of non-approved consumables or spare parts. As with any other sophisticated product, it is essential, and a condition of Seller's warranty, that all personnel using the product be fully acquainted with its use, capabilities and limitations as set forth in the applicable product literature.
3. **DISCLAIMER OF IMPLIED WARRANTIES.** Seller gives no warranties except those expressly contained herein. Seller **disclaims** all other warranties implied by law usage of the trade, course of dealing or course of performance including, but not limited to, **the implied warranties of MERCHANTABILITY and fitness for a particular purpose.**
4. **LIMITATIONS OF LIABILITY.** The following limitations of Seller's liability are acknowledged by the parties to be fair and reasonable and shall apply to any act or omission hereunder, and to any breach of this contract of which these terms and conditions form a part:
 - a. **Disclaimer of Damage.** In no event shall Seller be liable for special, indirect, consequential or incidental damages whether arising under contract, warranty, tort, strict liability or any other theory of liability. Such damages include but are not limited to loss of profits, loss of use of goods, damage to property, and claims of third parties.
 - b. **Suitability.** Buyer acknowledges that it alone has determined the intended purpose and suitability of the goods sold hereunder. It is expressly agreed by the parties that any technical or other advice given by the Seller with respect to the use of the goods or services is given without charge and at Buyer's risk; therefore Seller assumes no obligation or liability for the advice given or results obtained.
 - c. **Notice and Time of Claims.**
 - i. Buyer agrees to check and inspect all products against shipping papers and for damage or shortage upon receipt of goods at destination.
 - ii. Every claim for shortage, damage in transit, or other cause visible upon inspection shall be deemed waived by the Buyer, or the Buyer's customer in the case of resale, unless delivered in writing to Seller by Buyer thirty (30) days from the tender of delivery of the goods to Buyer, provided, however, that claims for shortage must be made within seven (7) days of receipt.
 - iii. The parties expressly waive the statute of limitations and agree that any legal proceeding for any breach of this contract shall be waived unless filed within one (1) year after the accrual of the cause of action thereof.
5. **FORCE MAJEURE.** Seller shall not be liable for any delay in delivery, or failure to deliver, due to any cause beyond the Seller's control including but not limited to fires, floods, or other forces of the elements; strikes, or other labor disputes; accidents to machinery; acts of sabotage; riots; precedence or priorities granted at the request or for the benefit, directly or indirectly of the federal or any state government or any subdivision or agency thereof; delay in transportation or lack of transportation facilities; restrictions imposed by federal, state or other governmental legislation or rules or regulations thereof. If Seller, in its sole discretion, determines that Seller's performance hereunder would result in a loss to Seller's on this sale as computed under Seller's normal accounting procedures because of causes beyond Seller's control, then the Seller may terminate this agreement in whole or in part without liability for any delay in the delivery of, or failure to deliver, the goods sold hereunder
6. **TAXES AND OTHER CHARGES.** The Buyer will pay, or reimburse Seller if it pays, any and all taxes or tariffs or any other similar charges imposed upon this contract, the goods covered hereby or the delivery or use or resale thereof.
7. **FREIGHT CHARGES.** If the sale hereunder is other than F.O.B. Seller's facility, this acknowledgement is based upon the freight charges now in effect. In the event of an increase or decrease in applicable freight charges before the goods are shipped, such charge in freight will be for the Buyer's account.
8. **PRICES AND DELIVERY.** Prices quoted herein are F.O.B. shipping point. Deliveries specified are only our best estimate and are subject to change. This quotation is based upon freight charges now in effect. Buyer will be invoiced at the freight charge prevailing at the date of shipment. Prices are firm for orders meeting Seller's normal shipping schedules. If shipments are held or postponed for any reason other than Seller's fault, and a price increase becomes effective during the period of such hold or postponement, the increase will apply to all shipments that are held or postponed thirty (30) days or more from the effective date of the increase.
9. **PAYMENTS.** If in the judgment of Seller the financial condition of Buyer at any time prior to shipment does not justify the terms of payment specified, Seller may cancel the order, withhold shipment, and/or require full or partial payment in advance. If payment is not made when due, Seller may suspend all future delivery or other performance with respect to Buyer without liability or penalty and, in addition to all other sums payable hereunder, Buyer shall pay to Seller (i) the reasonable costs and expenses incurred by Seller in connection with all actions taken to enforce collection or to preserve and protect Seller's rights hereunder, whether by legal proceedings or otherwise, including without limitation reasonable attorneys' fees, court costs and other expenses and (ii) interest on all amounts unpaid after 30 days charged at the monthly rate of 1-1/2% or the highest rate permitted by law, whichever is lower.
10. **CANCELLATION OR ALTERATION.** Buyer may not alter or cancel any order without Seller's written consent. For any order altered or cancelled with Seller's consent, Buyer must pay for all expenses and labor incurred up to the time of Seller's consent, plus a reasonable percentage for profit. Any order delayed or deferred by Buyer will be subject to price escalation for increased costs of production, and any other expenses caused by the delay. Material on such orders will be stored at Buyer's risk. Seller reserves the right to invoice Buyer and require payment before shipment of any delayed or deferred order.
11. **TITLE AND RISK OF LOSS.** Title and risk of loss shall HPSs to buyer at Irvine, California, unless otherwise specified in the contract. If delivery is made by common carrier, risk of loss shall HPSs upon delivery to the carrier. Claims for loss or damage in transit must be made by Buyer to the carrier. Seller accepts no responsibility for loss or damage to product in transit.
12. **PATENT OR TRADEMARK INFRINGEMENT.** If the goods sold hereunder are to be prepared for manufacture according to Buyers specification, Buyer shall indemnify Seller against any claim or liability for patent, trademark, service mark or trade name infringement on account of preparation, manufacture and/or sale.
13. **NON-WAIVER.** If Government Contract Regulations require the addition, deletion, or modification of these terms and conditions upon prior notification to Seller and Seller's written acceptance thereof, such changes shall become a part of these terms and conditions. Seller shall not be bound by any Government Contract Regulations applicable to Buyer's contracts with the U.S. Government unless Buyer has expressly acknowledged, on the face of this document, the applicability of such Regulations to the transaction between Buyer and Seller contemplated herein. Absent such acknowledgement, Seller is making the assumption in issuing this document that no such Regulations apply.

14. **JURISDICTION.** All such disputes shall be resolved in a court of competent jurisdiction in Orange County, California. Buyer hereby consents to the jurisdiction of the State and Federal Courts sitting in Orange County. Notwithstanding the above, should either party contest the jurisdiction of such courts, the other party may institute its suit in any court of competent jurisdiction.
15. **APPLICABLE LAW.** All questions arising hereunder or in connection with the quotations or any order submitted in connection therewith and/or the performance of the parties hereunder shall be interpreted and resolved in accordance with the laws of the state of California without regard to its conflict of law provisions and excluding the United Nations Convention on the International Sale of Goods.

RETURN GOODS POLICY

All requests for returned goods must be initiated through our Customer Service Department. Please call our phone number (714) 695-0051 with the specifics of your request. The following conditions must be satisfied for consideration of applicable credit for the return of products purchased from Electro-Chemical Devices:

- 1) The item is unused and in the original package.
- 2) The item was shipped directly from Electro-Chemical Devices.
- 3) The item has not been damaged in shipment to Electro-Chemical Devices.
- 4) Items containing date-sensitive parts such as electrodes, must be returned within 1 month of the invoiced date.
- 5) Items without date-sensitive parts must be returned within 3 months of the invoiced date.

A Return Merchandize Authorization Number must be obtained from Customer Service and be provided on all paperwork and packaging. To obtain a Return Merchandize Authorization Number, please provide the reason for return, the date of purchase, your original purchase order number, and either our order number or our invoice number. The issuance of a Return Merchandize Authorization Number is a verbal approval for return only and does not guarantee credit or allowance. Returned goods must be received within 30 days of the issuance date of the Return Merchandize Authorization Number or it will become null and void.

Necessary physical and mechanical inspection is completed upon receipt of the item. Applicable credit or equivalent allowance is determined after inspection of the returned item. If all of the above conditions are met, and the item has been approved to return to our stock, a restocking charge of 25% of the purchase price is deducted from the applicable credit.

UNPACKING THE INSTRUMENT

Your Electro-Chemical Devices instrument has been carefully packaged to protect it from damage during shipment and dry storage. Upon receipt please follow the procedure outlined below.

1. Before unpacking, inspect the condition of the shipping container to verify proper handling by the carrier. If damage is noted, save the shipping container as proof of mishandling for the carrier.
2. Check the contents of the shipping container with the items and quantities shown on the packing list. Immediately report any discrepancies to ECD.
3. Save the original packing material until you are satisfied with the contents. In the event the product(s) must be returned to ECD, the packing material will allow you to properly ship it to ECD.
4. Familiarize yourself with the instrument before installation, and follow proper installation and wiring procedures.



WARNING Electrical installation must be in accordance with the National Electrical Code (ANSI/NFPA-70), Canadian Electrical Code and/or any other applicable national or local codes.

Installation and wiring

Failure to follow the proper instructions may cause damage to this instrument and warranty invalidation.

Use only qualified personnel to install, operate and maintain the product.

The Model T80 transmitter should only be used with equipment that meets the relevant IEC, American or Canadian standards. ECD accepts no responsibility for the misuse of this unit.

Basic Parts List

1. Model HP80 Transmitter and sensors, Panel Mounted
2. Hydrogen Peroxide refill Solution
3. Instruction Manual

INSTRUCTION MANUAL REVISION

<u>Revision</u>	<u>Date</u>	<u>Remarks</u>
A	12/15	Initial release

1.0 GENERAL DESCRIPTION

The HP80 is a panel mounted, ready to use Hydrogen Peroxide (HP) analyzer. Hydrogen Peroxide is a colorless liquid with a characteristic pungent odor similar to vinegar. HP is produced by a reaction between hydrogen peroxide and acetic acid and is typically supplied as an equilibrium solution of the three with a concentration between 5-15%. It is a strong oxidizer, stronger than either Hydrogen Peroxide or Hydrogen Peroxide dioxide. Hydrogen Peroxide is widely used in the Food and Beverage, Pharmaceutical and Medical industries as a cleaner and sanitizer of process equipment, medical instruments and for bottle washing. It is also widely used as a disinfectant in cooling towers and municipal waste water treatment plants. HP is a highly effective bactericide that does not form any harmful Disinfection By Products (DBP) like many Hydrogen Peroxide products do. It decomposes naturally into acetic acid and water and does not form a residual that has to be removed from the treated water before it is released to the environment.

The HP80 features a plug and play design that incorporates a constant head flow control device, a pH sensor, a Hydrogen Peroxide sensor and the T80 analyzer/transmitter conveniently mounted on a PVC panel. Simply connect the sample and drain lines, connect the power and outputs and it is ready to use. Calibration is accomplished by a grab sample comparison.

The T80 is 110-240 VAC or 24 VDC powered and allows either parameter to be graphically displayed with user defined Line, Bar or Guage style graphs. The standard configuration has (2) 4-20 mA outputs, (3) alarm relays and MODBUS RTU. Amperometric HP sensors are flow sensitive, the minimum required flow by the sensor is 0.5 ft/sec, above this value the output is virtually flow independent. A "Constant head" Flow control Device (CFD) maintains the optimum flow HPSt the sensor over a wide range of incoming sample flow rates. The minimum flow required for the CFD is 10 gal/hr and the maximum flow is 80 gal/hr with the sample going to drain at atmospheric pressure. The Auto Clean option includes a solenoid actuated spray cleaner that uses either 30 psi process water or air. An easily adjusted timer controls the period and duration of the cleaning cycle.



1.1 FEATURES

- **Panel Mounted System**, Easy Installation
- **Plumb and Play Design**, Ready to Use
- **Multiple HP ranges**, 0-200 ppm or 0-2000 ppm
- **pH measurement (or others, ORP, pION, Cond) for added process information**
- **Automatic Flow Control**, Eliminates Pressure Regulators and Rotameters
- **T80 Transmitter Capability**, Dual Measurements, 24VDC or 110/220 VAC Power, Graphical Plots



1.2 SPECIFICATIONS

1.2.1 SENSORS AND FLOW TRAIN

Hydrogen Peroxide Sensor:

Digital protocol, Polarographic, Gold/Silver, micro-porous membrane

pH Sensor:

Digital S80 protocol, 316L stainless steel body with replaceable electrode cartridge

Measurement Range:

Hydrogen Peroxide: 0 to 200 ppm
(0 to 2000 ppm, 2%, 20% optional)

pH: 0 to 14 pH

Interferences:

Cl₂, PAA, O₃ must not be present

Sulfides contaminate measuring system.

Phenol >3% destroys sensor membrane

Operating Temperature:

0° C to 50° C (32° F to 122° F)

Min/Max Flow:

38 L/hr. to 300 L/hr. (10 gal/hr. to 80 gal/hr.)

Wetted Materials:

PVC, PP, PVDF, PTFE, Glass, 316 SS

Process Connections:

Input ¼" FNPT with barb fitting, Drain ¾" FNPT

Response Time:

T90 in 2 minutes

Electrolyte Life:

Up to 12 months



1.2.2 HP80 ANALYZER

Measurements:

Hydrogen Peroxide: 0 to 200 ppm or 0 to 2000 ppm, (0 to 2000 ppm, 2%, 20% optional) auto ranging

pH: 0.00 to 14.00 pH

pH Compensation: none, measurement between 2-11 pH

Display:

128 x 64 pixels (2.75" x 1.5") LCD, Black on Grey background, Blue on White background with LED backlight on

Outputs:

(1) 4-20 mA for Hydrogen Peroxide set to Sensors Range

(1) 4-20 mA for pH (Optional) set 0-14 pH

Modbus RTU (standard)

Alarm Relay Ratings:

Three (3) SPDT, 1 form C, 250 VAC, 10 Amp resistive maximum, relays, user configurable as Hi/Lo alarms with expiration timer, Periodic Timers or Fault alarms

Input Power

Code -1 24 VDC (18-36 VDC @ 250 mW minimum)

Code -2 100-240 VAC, 50/60 Hz, 4W, protected with 250V, 1A, Slow Blow fuse

Enclosure:

Beige Polycarbonate, IP65, weatherproof, ½ DIN, (L x W x D) 5.7" X 5.7" X 3.5" (14.4cm X 14.4cm X 9.0cm)

Environmental Conditions:

Outdoor use (IP65)

Ambient Temperature

-20°C - 70°C (24 VDC Models)

-20°C - 60°C (100-240 VAC Models)

Storage Temperature

-30°C - 85°C

Relative Humidity

0 – 80%, up to 31°C

Decreasing linearly to 50% RH a 40°C

Altitude

Up to 2000 m (6500 ft)

Mains Supply Voltage

Fluctuations up to ±10% of the nominal voltage

Transient over voltages: CAT II

Pollution Degree: 2

1.3 MODEL CODES

Model HP80-					
Sensor type and Range	0 0 to 200 ppm Hydrogen Peroxide (Standard)				
	1 0 to 2000 ppm Hydrogen Peroxide				
pH	1 pH Sensor (Standard)				
	Power	-1 24 VDC Powered Transmitter			
		-2 100-240 VAC powered Transmitter			
	Outputs and Relays	1 (x1) 4-20mA Outputs & (3) Relays			
		2 (x2) 4-20mA Outputs & (3) Relays (Standard)			
	Spray cleaner	00 No Spray Cleaner			
10 Spray Cleaner on Hydrogen					
HP80-	0	1	-2	1	10

Example above shows part# HP80-01-2210, a two channel HP80 transmitter, 0 to 200 ppm Hydrogen Peroxide range and S80 pH sensor, 110/220 VAC powered with two 4-20 mA outputs with MODBUS RTU, 3 Relays (one used for Spray Cleaning option) and spray cleaner.

2.0 INSTALLATION

Mount the HP80 in a location where there is easy access to the analyzer and sensors. Install the system in an area where vibrations, electromagnetic and radio frequency interference are minimized or absent. Do not mount in direct sunlight or areas of extreme heat. The HP80 is suitable for outdoor use if mounted with a protective cover or sunshield.

2.1 MOUNTING

The HP80 panel is drilled with 4 x 0.265" holes, one at each corner, and is designed to use 1/4" -20 hardware or 6mm metric hardware.

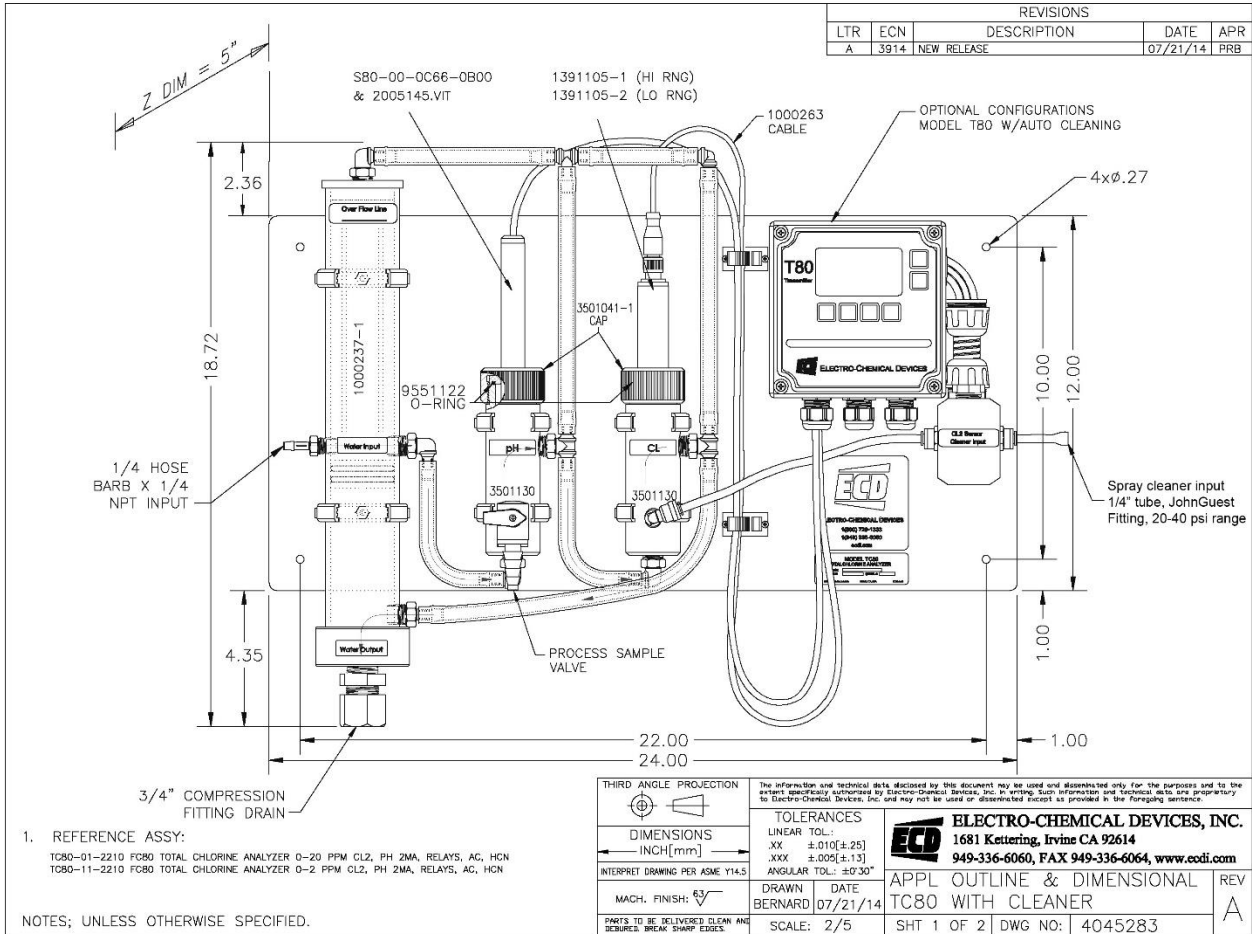

2.2 WIRING

Electrical wiring should only be conducted by qualified personnel. See the T80 wiring diagram in Figure 2.2.2

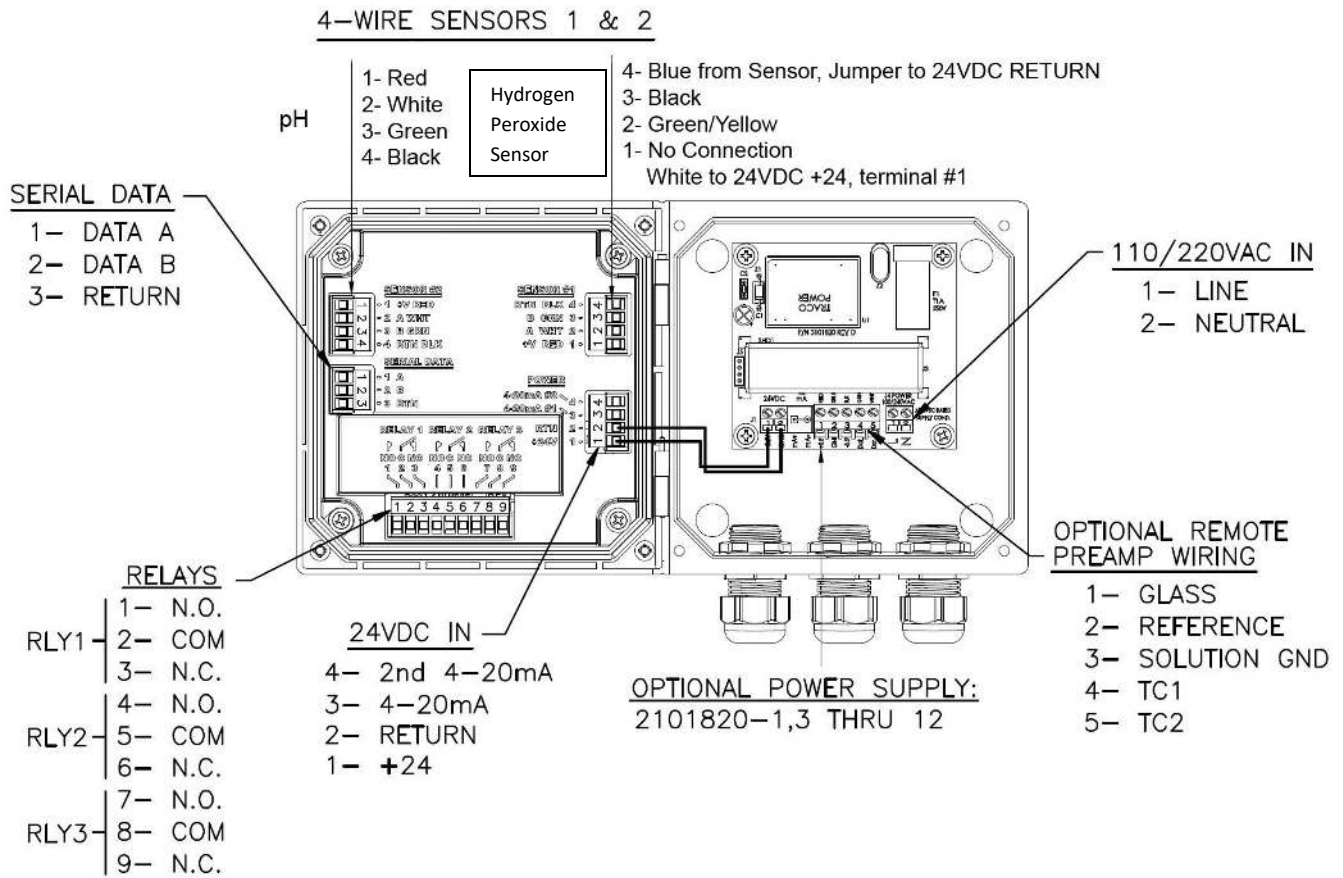





Figure 2.2.2 4-Wire Transmitter, 24VDC or /110/22 VAC, MODBUS, Relays/Optional Digital Preamp

	Warning: RISK OF ELECTRICAL SHOCK
	Disconnect Power before opening instrument.
	WARNING Electrical installation must be in accordance with the National Electrical Code (ANSI/NFPA-70), Canadian Electrical Code and/or any other applicable national or local codes.

2.2.1 WIRING, POWER

ECD recommends using a thermoplastic, outdoor sunlight resistant jacketed cable, wet location rated and ½” flexible conduit. The power should be hard wired with a switch or breaker to disconnect the analyzer from the

main power supply. Install the switch or breaker near the analyzer and label it as the Power Switch for the analyzer.

24VDC (4 wire configuration)

Attach the 24VDC power cable to terminals #1 and #2 as shown in Figure 2.2.2 and on the diagram inside of the T80 cover. Attach the 4-20 mA1 cable to terminals #3 (out) and #2 (return) single channel unit and attach the 4-20 mA2 cable to terminals #4 (out) and #2 (return) for a two channel instrument. Feed the cables through the gland fitting on the right hand side of the T80. Tighten the cable gland to provide a good seal to the cable. The instrument can be powered up at this point with no harm to the analyzer but it is best to wait until the sensors are installed.

110/220 VAC (4 wire configuration)

Attach power cable as shown in Figure 2.2.2 or as on the diagram inside of the T80 cover. Feed the cable through the gland fitting on the right hand side of the T80. Tighten the cable gland to provide a good seal to the cable. The instrument can be powered up at this point with no harm to the analyzer but it is best to wait until the sensors are installed.

2.2.2 WIRING, SENSOR

The Hydrogen Peroxide Sensor and the S80 pH Sensor were connected to the HP80 analyzer at the factory, no additional connections are necessary. Color coded connections for these sensors are shown in the wiring diagrams in Section 8.3 or on the inside cover of the T80 transmitter.

When replacing a sensor, attach the sensor wires as described above. Feed the sensor cable through the gland fitting on the left hand side of the T80. Do not use the same gland fitting for the AC power or Alarm/Relays. The green terminal strip connectors are detachable from the circuit boards. Remove the connector by pulling straight back from the circuit board.

2.2.3 WIRING, 4-20 MA OUTPUTS

24 VDC or 110/220 VAC powered instruments:

For instruments powered with 24VDC or with the internal 110/220 VAC power supply, Model T80-XX-1X-XX (24VDC) and T80-XX-2X-XX (110/220 VAC), connect the 4-20 mA cable(s) to terminals #3 (out) for channel 1 and #2 (return) and to terminals #4 (out) for channel 2 and #2 (return).

2.2.4 WIRING, CONTACT RELAY OUTPUTS

The standard configuration has three SPDT 230V 5 A relays that can be wired either **normally open (NO)** or **normally closed (NC)**. The default configuration is set to use the relays as normally open. If the optional spray cleaner was ordered then one of the relays is used to control the cleaning cycle.

2.2.5 WIRING, SERIAL OUTPUT MODBUS RTU

Attach the sensor wires as shown in Figure 2.2.2 or as described on the diagram inside the T80 cover. Feed the sensor cable through the gland fitting on the left hand side of the T80. Do not use the same gland fitting for the AC power or Alarm/Relays. See MODBUS command register in [Appendix B](#).

2.3 INSTALLING THE SENSORS

The HP80 is supplied with the sensor cables pre-wired to the analyzer. Use the following procedure for sensor installation and calibration.

The pH sensor (or other second measuring sensor) mounts in the Flow Cell using an o-ring sealed flange/union mount with threaded locking cap. First remove the protective cap from the sensing end of the sensor and save it for future use, the cap contains a potassium chloride solution use care when removing the cap from the sensor. Insert the sensor into the flow cell. There is an o-ring seal inside the flange that seals against the face of the flow cell. Slide the sensor into the flow cell and then hand tighten the knurled compression cap to fix its position.

The Hydrogen Peroxide sensor is shipped in a separate box where the membrane cap is loosely screwed on the sensor.

1. Pull the protective clear plastic cap off the membrane cap and unscrew the membrane cap.
2. Place the membrane cap onto a clean base and fill up with the supplied electrolyte up to the thread lines.
3. Next you would need to take out the G-Holder from its plastic bag, and using the supplied tweezers, place it into the already filled membrane cap. The G-Holder should fit exactly in the middle of the membrane cap.
4. Holding the sensor upright, place it onto the filled membrane cap with the mounted G-Holder already positioned. Then screw the sensor slowly clockwise into the membrane cap. Make sure the red O-Ring is in its proper position as it properly seals of the membrane cap. Screw the membrane cap tightly to the electrode shaft. Doing this, excess electrolyte is spills out from the top of the cap.

Once the cap is completely screwed on, make sure that there are no electrolyte leaks.

The sensor is ready to use, connect the sensor to the HP sensor cable (that is connected to the T80 transmitter) then polarize the sensor for 24 hours before calibration. (See Calibration section 4.2 below)

Refill the sensor with electrolyte (PN 100246-1) every 3-6 months, depending on the operating conditions.

2.4 PLUMBING

2.4.1 SAMPLE REQUIREMENTS

The constant head flow controller can adapt to changing sample flows between 10 and 80 gal/hr. (40-300 L/hr.)

Minimum flow: 10 gal/hr. (38 L/hr.)

Sample Pressure: 1 to 30 psig (0.1 - 2 bar)

Temperature: 32° to 122°F (0° to 50°C)

2.4.2 CONNECTING THE INLET AND DRAIN FITTINGS

The HP80 is intended for wall mounting only.

Sample Inlet:

A ¼" barbed fitting is provided for the sample inlet. If desired, a ¼" compression fitting can be used. The sample inlet is ¼" FNPT. Attach the feed water line to the Constant Head Flow Controller with an adjustable shut off valve.

Sample Drain:

The sample drains through the ¾" FNPT hole at the bottom of the CHFC. Attach a ¾" fitting to a length of soft tubing and allow the waste to drain to open atmosphere. Do not restrict the drain line.

The sample can be introduced after the sensors have been calibrated and installed in the flow cells.

2.4.3 ADJUSTING THE SAMPLE FLOW RATE

Adjust the flow so the sample water fills the tube and slightly overflows into the center tube to drain. This provides a constant flow to the Hydrogen Peroxide and pH sensors controlled by the height of the water column. The sample flow rate must always be high enough to overflow the center tube or variations in the flow rate will occur causing decreased output from the Hydrogen Peroxide Sensor.

Once the sample has been introduced, purge the air in the lines by squeezing and releasing the tubing connecting the flow cells. First the tubing from the CHFC to the first flow cell and the tubing between the flow cells. The water draining back to the CHFC typically flows fast enough to arc to the center drain hole. A dribbling flow indicates an obstruction or air bubble trapped in the flow train.

2.5 CONNECTING THE OPTIONAL SPRAY CLEANER



Warning: The Relay controlling the solenoid will trigger upon Power Up which starts a cleaning cycle. The Sensors should be installed with the Sample flowing before powering the analyzer.

1. Remove the ¼" polypropylene tube from the John Guest fitting on the right side of the solenoid cleaner enclosure.
2. Provide 20-40 psi water or air to the ¼" Push fit fitting.
3. Manually actuate the relay for test purpose in SIM > RELAYS > RLY 1 > ON/OFF

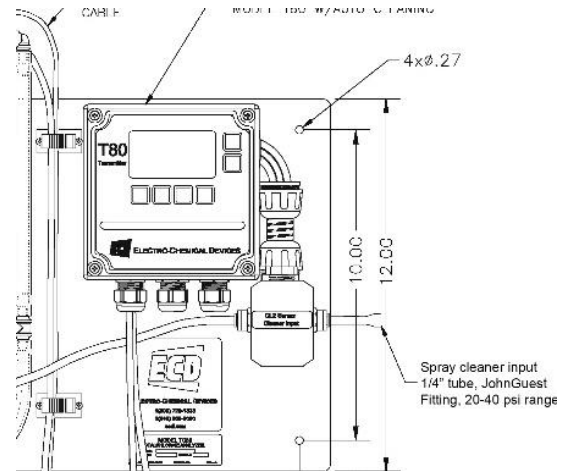

3.0 OPERATION

This section provides a basic overview of the ECD HP80 Hydrogen Peroxide Analyzer. It covers physical and chemical influences on the measurement and the menu structure of the analyzer.

3.01 INFLUENCES ON THE MEASUREMENT

PH, CLO₂, O₃

The Hydrogen Peroxide Sensor (HPS) measures Hydrogen Peroxide and the Hydrogen Peroxide concentration does not change with changes in the pH, there is always the same amount of Hydrogen Peroxide. However, Hydrogen Peroxide degrades above pH 8, and this would be indicated in the measurement. Interferences include: CLO₂ is registered with a 1 to 1 factor for its measuring value O₃ has a large interference with approximately 2500 to 1 for its measuring value.

3.02 INFLUENCES ON THE MEASUREMENT

FLOW

The HPS consumes Hydrogen Peroxide to produce the signal. The area near the sensing tip will become depleted of Hydrogen Peroxide without adequate flow to replenish the sample. The sensor requires a minimum velocity of 0.5 ft./sec HPSt the membrane. Below this value the sensor will indicate a lower concentration than the actual value. Higher flow rates have little to no effect on the measurement. See Figure 3.2.

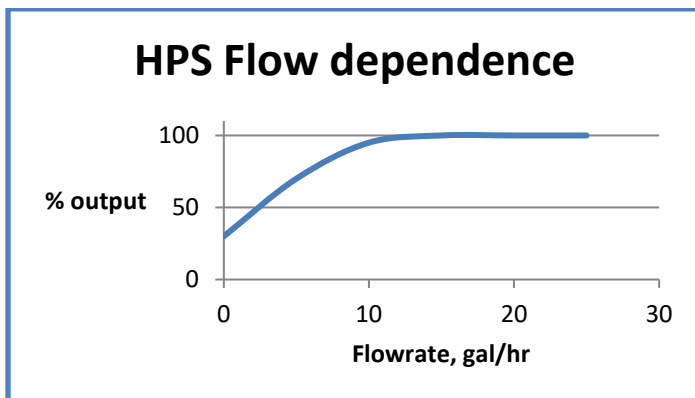
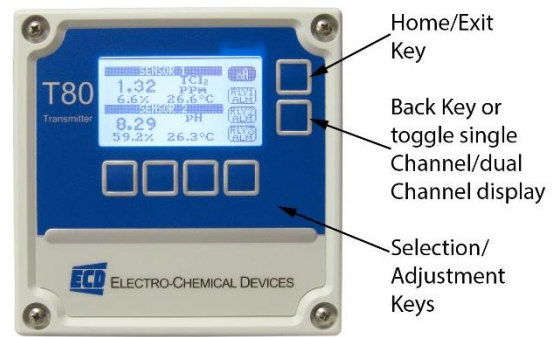

Figure 3.1

3.03 INFLUENCES ON THE MEASUREMENT

TEMPERATURE

The Hydrogen Peroxide Sensor (HPS) digitally outputs a temperature corrected value to the transmitter. The temperature sensor is located in the HPS sensor and it has a response time of several minutes. Rapid changes of temperature will introduce an error until the sensor has equilibrated to the new temperature. Calibration should be done close to the process temperature for the highest accuracy.



3.1 KEYS

The functions associated with each key are displayed on the screen, above the key for the Selection Adjustment Keys and to the left of the key for the HOME and BACK keys. **Press any Selection Adjustment key twice within one second to enter the HOME Menu Screen.**

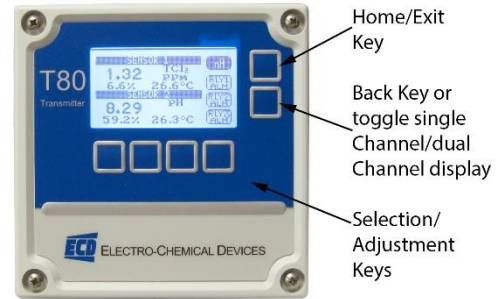

3.1.1 HOME/EXIT KEY

The **HOME key** performs two functions, it selects which Home Screen is displayed and it returns the active screen to the HOME Menu Screen from anywhere inside the menu structure.

Three Display screens are available: (Press BACK Key until a single channel is the HOME Key)

1. **DATA SCREEN:** Displays the measurement type, numerical value, engineering Units, % Output of the 4-20 mA channel and temperature.
2. **nA SCREEN:** Displays the measurement type, the sensor's raw nano-amp Value, % Output of the 4-20 mA channel and temperature.
3. **GRAF SCREEN:** Displays a Graphical representation of the 4-20 mA channel % Output, the measurement type, the engineering units, and temperature. Only one of the three graphical display styles is available through the HOME key, either the Bar, Gauge or Line display. Choose which style will be displayed in the Graph Menu. (pathway to Graph Menu: CONFIG → XMTR → LCD → Graph menu)

Each of the above screens also displays the condition of the optional Alarm Relays, black if energized and white if de-energized.

The HOME key changes to the **EXIT key** in the HOME Menu Screen, pressing EXIT prompts the user to "Save Changes" YES/NO when exiting the HOME Menu. YES applies any changes made in the menus, NO exits the HOME Menu without applying any changes made in the menus.

3.1.2 BACK/HOLD KEY

The **BACK key** changes the screen to the previously displayed screen when inside a menu, it moves BACK one screen. On a dual channel transmitter it toggles between the PV1, PV2 and Dual Channel Screens. The **HOLD key** toggles the output HOLD function ON/OFF in the MENU HOME screen.

3.1.3 SELECTION ADJUSTMENT KEYS

The (4) Selection/Adjustment keys allow navigation and numerical adjustments to be made in the MENUS. **To enter the HOME Menu screen press any of the Selection/Adjustment keys twice within one second.** The various Menu choices

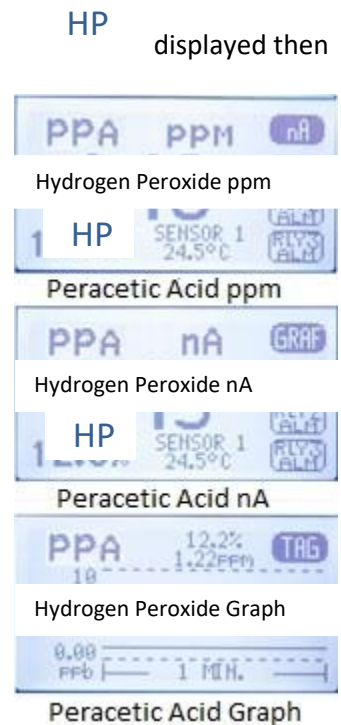

HP

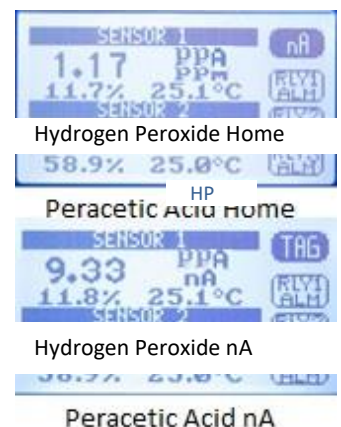

and adjustment tools are displayed above the buttons once inside the MENU.

3.1.4 ALPHA NUMERIC ENTRY

The **LABEL** and **PASSWORD** (Caps and Numbers only) Menus allow alphanumeric entry. Entry is accomplished by scrolling through the alphanumeric list with the ▲ (forward) and ▼ (backwards) arrows to the character of choice and then moving to the NEXT digit. Pressing and holding the ▲ or ▼ keys will initiate two speed auto scrolling. The character set is sequentially listed below. The first character in the set is an empty space.

! " # \$ % & ' () * + , - . / 0 1 2 3 4 5 6 7 8 9 : ; < = > ? @ A B C D E F G H I J K L M N O P Q R S T U V W X Y Z [\] ^ _ ' a b c d e f g h i j k l m n o p q r s t u v w x y z { | } → ←

3.2 MENU STRUCTURE

Double tap any Selection/Adjustment key to enter the HOME Menu Screen. Five menu choices will appear, **CAL**, **CONFIG**, **INFO**, **SIM** and **HOLD**. Each of the Menus is detailed below.

3.2.1 HOLD (OUTPUT HOLD)

Pressing the **HOLD Key** activates the HOLD function, HOLD is ON, displayed.

- ❖ Freezes the 4-20 mA output at the last value prior to activation
- ❖ Freezes optional Alarm Relays in the current state
- ❖ While in the HOLD mode the % Output display toggles between the last value and HOLD

Pressing HOLD again turns the hold function off, Hold is OFF, displayed. The HOLD function remains ON until it is turned OFF. (See Time Out in CONFIG>XMTR>OUTPUT>HOLD)



3.2.2 CAL (CALIBRATION MENU)

Four options are available, **AUTO**, **STAND**, **MANUAL** and **TEMP**. On dual channel instruments choose Sensor 1 or Sensor 2 when prompted.

The first screen asks, “Is this a New Sensor, YES / NO”. If YES the calibration history from the previous sensor is cleared from memory and a new register is started, if NO then the calibration is written to the memory stack, (3) sets of data are stored.

- ❖ **AUTO** is a two point calibration. The calibration proceeds in two steps, Auto Cal 1 is an offset calibration and Auto Cal 2 is a slope calibration. Auto Cal provides automatic solution recognition of the calibration solutions used for each measurement in accordance with the following list:

1. pH Calibration Buffers (US Standard), pH 4.01, pH 7.00 and pH 10.00 (see [Appendix A](#))
2. Hydrogen Peroxide: Zero ppm solution, Hydrogen Peroxide ppm solution - known value of a “grab sample” tested. (can use ECD Model HCA-1 Photometer Test Kit P/N 1000040-7

Any two solutions can be used for AUTO calibration however if solutions other than those listed above are used for calibration then the calibration values must be entered manually.

- ❖ **STAND** is standardization, a single point calibration. Standardizations are typically used to adjust the process reading to agree with a laboratory determined “grab sample” reading.

- ❖ **MANUAL** is a data entry screen. Manual calibration allows the user to enter a concentration with the corresponding mV value and a slope for an electrode.



Laboratory generated calibration data for an electrode can be input to a remote analyzer where calibration is difficult or impractical.

- ❖ **TEMP** allows the displayed temperature to be trimmed to agree with actual process temperature.

3.2.3 CONFIG (CONFIGURATION MENU)

Four options are available in the Configure Menu, **XMTR**, **SENSOR**, **LOAD DEFAULT** and **Dampen**.

- ❖ **XMTR** enters the Transmitter Configuration menu.

- **LCD** access the Display Configuration Menu
 - **SETUP** adjust screen lighting characteristics
 - **Temp.** Choose °C or °F
 - **CONT** adjust Contrast
 - **BACK LIGHT** adjust Backlight Timeout, from always ON to OFF after 10 minutes
 - **GRAPH** provides the choice of which Graph style is displayed on the Home screen.
 - **LINE**, Moving average, vertical scale set to 0-100% of the 4-20 mA output and user defined time scale
 - **GAUGE**, Current reading 0-100% of 4-20 mA range
 - **BAR**, Current reading 0-100% of 4-20 mA range
 - **LABELS**
 - **TAG**, Enter up to 2 lines x 16 characters, example, Name, tag #... Displayed in INFO screen
 - **TAG ON**, Turn TAG ON/OFF, adds TAG to Main Display Sequence, DATA → mV → GRAF → TAG → DATA
 - **POP UP**, Turns ON/OFF, the double tap HOME Screen pop up memo
 - **SENSOR**, Enter up to 2 lines x 16 characters
- **OUTPUT** access the Output Configuration Menu
 - **4-20 mA** configure 4-20 mA output (PV or Temp or More)
 - **PV RANGE** Enter 4 mA value and 20 mA value
 - **Temp RANGE** Enter 4 mA value and 20 mA value
 - **MORE**
 - **CAL** Trim 4.00 mA and 20.00 mA output
 - **FAULT** Choose fault condition 3.5 mA, 22 mA, None
 - **RELAY**
 - **RLY1,2,3** Choose relay type:
 - **Alarm**, enter the Set point ON, Set Point OFF, Expiration time, Delay ON and Delay OFF times and the State, **energize**: changes state from de-energized to energized on alarm.
 - **Timed**, Enter Period, Duration times and

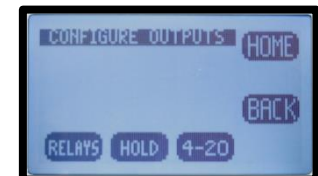
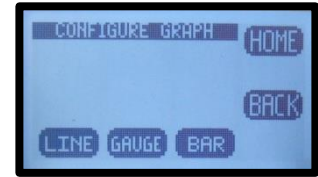

Hold On/Off

- **Fault**, No input required, relay condition changes from energize to de-energize.
- **Disable**, Inactivates relay and removes the relay button from the HOME Screen display.



- **HOLD**, Freezes outputs at current value and locks relays in their current state.
 - **Hold Timeout**, Removes HOLD after a certain period of time, default setting: No Timeout, selections include 15 minutes, ½ hour, 1 hour



- **SERIAL MODBUS** configure serial output,
 - **ADDRESS**, enter address: 001 to 247
 - **BAUD**, Choose baud rate, default 9600
 - **FORMAT**, set serial data format, default value: 8N1, 8 bit, no parity bit, 1 stop bit
- **HPSSWD** Enter 4 character Password to protect access to MENU Level, CAL Menu, CONFIG Menu and SIM Menu (simulate). Each level can be turned ON or OFF and can have a unique Password.
 - **MENU** ON/OFF _____ Locks Main Menu
 - **CAL** ON/OFF _____ Locks CAL and CONFIG
 - **CONFIG** ON/OFF _____ Locks CONFIG
 - **SIM** ON/OFF _____ Locks SIM and CONFIG



❖ **SENSOR** enters the sensor configuration menu.

- **Choose SENSOR 1 or 2**
 - **TYPE**, Allows T80 transmitter to configure the S80 sensor. For use only when switching the measurement electrode type in an S80 sensor, i.e. for a pH electrode to a pION electrode. Select Sensor Type: pH, ORP, DO₂, NH₃, NH₄⁺, Br⁻, Ca⁺⁺, Cl⁻, Conductivity, Resistivity, Cu⁺⁺, CN⁻, F⁻, NO₃⁻, K⁺, Ag⁺, Na⁺, S⁻
 - **T COMP**, Enter % temperature compensation per degree: pH, 0.33%, Hydrogen Peroxide 0%,
- **COMP** Dual Channel Only, Sets compensation type: **Dissociation** (pKa), NH₄⁺, Free Hydrogen Peroxide, HF, S⁻², **Interference**, X ppm Sensor 2 = 1 ppm Sensor 1, **Percentage** = 0.00%
- **Qty of SENSORS**, Choose 1 or 2



❖ **Load Default** resets all Menus to factory default configuration.

❖ **Dampen**, sets the number of measurements averaged for the displayed PV

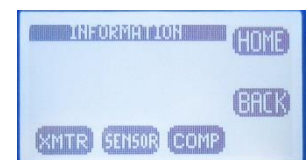

3.2.4 INFO (INFORMATION MENU)

The Information Menu provides two choices,

- ❖ **Transmitter Screen**, details the Name, Power type, Serial #, Firmware version and the output configuration(s).
- ❖ **Sensor Screen**, details the Name, Part #, Serial # and three sets of Calibration data.
- ❖ **COMP**, displays the pKa, the sensor affected and the dissociation Factor,

3.2.5 SIM (SIMULATION MENU)

The Simulation menu allows the Input or Output signals to be simulated.

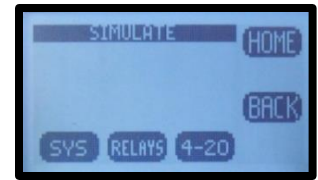

- ❖ **SYSTEM** allows the Input to be simulated. Two choices are available, FIXED is a fixed value, RAMP varies the signal across the 4-20 mA range, from the lowest value to the highest value and back, activating and deactivating relays if present. The RAMP has two adjustments the Ramp period, 30 seconds to 2 minutes and Duration; 1 cycle, 5, 10, 20, 30 minutes.
- ❖ **RELAYS** allows individual relays, #1, #2, and #3 to be activated and deactivated
- ❖ **4-20 mA** allows the output to be simulated from 4.00 mA to 20.00 mA.

3.2.6 FAULT SCREENS

Fault	Definition	Recommendation
Memory Error	AN ERROR WAS FOUND WITH THE MEMORY OF THE MICROCONTROLLER	RETURN TO FACTORY FOR SERVICE
Input Voltage OOT	POWER IS OUT OF TOLERANCE	CHECK WIRING TO THE TRANSMITTER
+12V OOT	ONBOARD 12V IS OUT OF TOLERANCE	RETURN TO FACTORY FOR SERVICE
+3.3V OOT	ONBOARD 3.3V IS OUT OF TOLERANCE	RETURN TO FACTORY FOR SERVICE
Loss of Comm	COMMUNICATION WITH THE SENSOR WAS LOST	CHECK WIRING TO THE SENSOR
No Sensor	NO SENSOR WAS FOUND AT START-UP	CHECK WIRING TO THE SENSOR
Cal Failed	SENSOR CALIBRATION FAILED	1) CLEAN SENSING TIP 2) VERIFY SOLUTIONS 3) DO NOT LEAVE UNATTENDED 4) RE-CALIBRATE
Relay 1 Expired	RELAY 1 TIME ON EXPIRED	1) CHECK SENSOR OP 2) CHECK AUX EQUIP A) PUMPS B) TANKS
Relay 2 Expired	RELAY 2 TIME ON EXPIRED	1) CHECK SENSOR OP 2) CHECK AUX EQUIP A) PUMPS B) TANKS
Relay 3 Expired	RELAY 3 TIME ON EXPIRED	1) CHECK SENSOR OP 2) CHECK AUX EQUIP A) PUMPS B) TANKS

3.3 OUTPUT CONFIGURATION GUIDE

Install and wire the T80 Transmitter as described in Sections 2.1 and 2.2 above.

Connect the sensor to the transmitter as described in Section 2.2 above.

Supply power to the Model T80 transmitter.

Verify the proper measurement type is displayed, pH and Hydrogen Peroxide. The sensor automatically uploads the measured parameter, the calibration data and the range of measurement to the transmitter. The default configuration of the 4-20 mA output is the range of the sensor, 0-14 pH for pH sensors and 0.00 -20.00 ppm for Hydrogen Peroxide. To change the 4-20 mA range, follow the instructions in Section 3.3.1 below.

3.3.1 CONFIGURE 4-20 MA OUTPUT RANGE

- ❖ Double press any key except the HOME key to enter the HOME Menu. Follow the path below to set the 4-20 mA range.
- ❖ HOME Menu → Press CONFIG → XMTR → OUTPUT → 4-20 (1)(2) → PV or TEMP
- ❖ Press CHANGE to enter New Values.
- ❖ Choose 4 mA value, press OK
- ❖ Enter value using ▲ or ▼ and NEXT to move to the next digit, press OK→Back
- ❖ Choose 20 mA value, press OK,
- ❖ Enter value using ▲ or ▼ and NEXT to move to the next digit, press OK→Back
- ❖ Press BACK to return to the CONFIGURE 4-20 mA screen or HOME to return to the HOME Menu screen.

3.3.2 CONFIGURE 4-20 MA FAULT CONDITION AND CAL

- ❖ In the CONFIGURE 4-20 mA screen, Press **MORE** → **FAULT** or
- ❖ Choose **Low Fault 3.5 mA** or **Hi Fault 22 mA** or **NONE**, (default setting **NONE**), Press OK
- ❖ Press BACK → **CAL**, (enter PW 0000) connect DVM to 4-20 mA line, Press 4.00 mA then adjust value to the DVM reading, Press 20.00 mA and adjust value to the DVM reading. The 4-20 mA output is calibrated.

3.3.3 CONFIGURE ALARM RELAYS (RELAYS OPTIONAL)

- ❖ HOME Menu → Press CONFIG → XMTR → OUTPUT → RELAYS→RLY1
- ❖ Choose the **ALARM**, **TIMER**, **FAULT** or **DISABLE** mode for Relay 1
- ❖ **ALARM** Displays:
 - **SET POINT ON**: The Process Variable Value that activates the relay.
 - **EXPIRATION**: Enter a time that should not be exceeded before the PV should have changed enough to activate the OFF set point. At the Expiration time the relay is deactivated and a Fault condition is initiated. Fault: Relay 1 Time expired: Cause: Loss of reagent, failed sensor
 - **Delay ON**: The amount of time the PV must remain above/below the set point before the relay activates.
 - **SET POINT OFF**: The Value of the process variable that deactivates the relay.
 - SET POINT OFF > Set Point → Low Set Point
 - SET POINT OFF < Set Point → Hi Set Point
 - **Delay OFF**: The amount of time the PV must remain above/below the hysteresis point before the relay deactivates.
 - **STATE: Energize** (relay is energized on activation)/**De-energize** (relay is de-energized on activation)
- ❖ **TIMER** activates the relay periodically for a specific duration, user configured period and duration



- ❖ **FAULT** sets the relay condition to a de-energize state and NC relay closes in response to a Fault condition or power failure.
- ❖ **DISABLE** turns off the relay and removes it's icon from the HOME screen

Setting up an Alarm Relay

- ❖ Choose **ALARM**
- ❖ Press **CHANGE** to enter new values
- ❖ Choose ON Set Point, Press OK
- ❖ Enter value using ▲ or ▼ and NEXT to move to the next digit, press OK, press BACK (Min –Max values indicate the range of acceptable values)
- ❖ Choose Expiration, Press OK,
- ❖ Choose time from drop down menu using ▲ or ▼, press OK, press BACK
- ❖ Choose OFF Set Point, Press OK
- ❖ Enter value using ▲ or ▼ and NEXT to move to the next digit, press OK, press BACK
- ❖ Choose Delay ON, Press OK
- ❖ Enter value using ▲ or ▼ and NEXT to move to the next digit, press OK, press BACK
- ❖ Choose Delay OFF, Press OK
- ❖ Enter value using ▲ or ▼ and NEXT to move to the next digit, press OK, and press BACK when done to exit Relay 1.
- ❖ Repeat for Relay 2 and Relay 3.

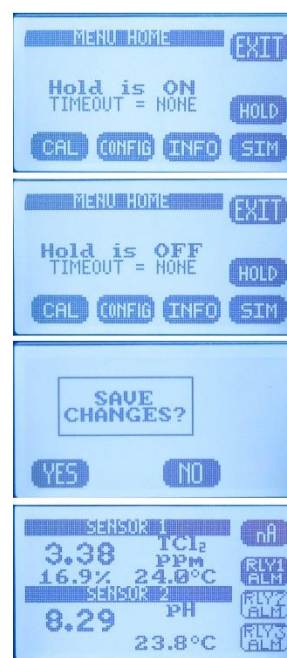

3.3.4 EXIT MENUS AND RETURN TO MAIN DISPLAY

- ❖ Press HOME Key to return to the Home Menu Screen
- ❖ Press Hold to turn OFF Hold
- ❖ Press EXIT Key to exit the menu
- ❖ "Save Changes?" press YES
- ❖ Choose Display Mode, **DATA**, **mV** or **GRAF** by pressing selection Key. The selection key displays which screen will be displayed next.
 - The type of graphical display used, Line, Bar or Gauge is selected in CONFIG → XMTR → LCD → GRAPH → LINE, GAUGE, BAR

3.3.5 SENSOR START UP

All sensors are supplied with protective caps over the sensing end. Remove the cap(s) from the sensor before installing in the process. All sensors were calibrated at the factory before shipment, no calibration should be necessary before use. Allow the sensor to equilibrate to the process solution conditions for ½ hour before verifying the reading against a grab sample. If calibration is required follow the instruction in Section 4.0 below.

3.4 USER SELECTABLE OPTIONS

3.4.1 SCREEN LIGHTING

LED back lighting is available on AC and DC powered instruments only.

Contrast can be adjusted for optimal viewing. The Backlight can be adjusted to timeout after a set period of time or remain on.

Location: CONFIG → XMTR → LCD → Set Up → CONT, BACK LIGHT

3.4.3 GRAPHICAL DISPLAY

There are three graphical display choices:

- ❖ **LINE**, The Line graph is a moving average of the process variable with the 4-20 mA range as the maximum/minimum values and a choice of time scales.

The Time scale is the amount of time displayed across the full screen. Choices include:

Full Screen Period	15 minutes	1 hour	12 hours	1 day	2 days
Sample Rate (1 point every)	10 seconds	40 seconds	8 minutes	15 minutes	30 minutes

- ❖ **GAUGE**, Live reading displaying 0-100% of 4-20 mA range. The Alarm Relay number(s), #1, #2 and#3 mark the respective set points on graph.
- ❖ **BAR**, Live reading displaying 0-100% of 4-20 mA range. The Alarm Relay number(s), #1, #2 and#3 mark the respective set points on graph.

Pressing **OK** after selecting a Graphical Display will exit the menu structure and return to the Main Display.

Location: CONFIG → XMTR → LCD → GRAPH

3.4.4 TAG TRANSMITTER NAME

Two 16 character lines are available for naming the transmitter, Upper and Lower case characters, Numbers and Punctuation are available. The information entered will be displayed in the INFO screen and optionally in the Main display sequence if activated in the TAG ON menu. The character set is listed below sequentially; the first character in the set is an empty space.

! " # \$ % & ' () * + , - . / 0 1 2 3 4 5 6 7 8 9 : ; < = > ? @ A B C D E F G H I J K L M N O P Q R S T U V W X Y Z [¥] ^ _ ' a b c d e f g h i j k l m n o p q r s t u v w x y z { | } → ←

Entry is accomplished by scrolling through the alphanumeric list with the ▲ (forward →) and ▼ (backwards ←) arrows to the character of choice and then pressing **NEXT** to advance the cursor to the next digit. Pressing and holding the ▲ or ▼ keys will initiate two speed auto scrolling. Press **BACK** to exit the screen.



Location: CONFIG → XMTR → LCD → LABELS → TAG

3.4.5 SENSOR NAME

Two 16 character lines are available for naming the Sensor, Upper and Lower case characters, Numbers and Punctuation are available. The information entered will be displayed in the INFO screen. Entry is accomplished by scrolling through the alphanumeric list with the ▲ (forward →) and ▼ (backwards ←) arrows to the character of choice and then pressing **NEXT** to advance the cursor to the next digit. Pressing and holding the ▲ or ▼ keys will initiate two speed auto scrolling. Press **BACK** to exit the screen.



Location: CONFIG → XMTR → LCD → LABELS → SENSOR

3.4.6 PASSWORD PROTECTION

HPSSWD Enter 4 character Password to protect access to MENU Level, CAL Menu, CONFIG Menu and SIM Menu (simulate). Each level can be turned ON or OFF and can have a unique Password. Upper Case Characters and Numbers are available for use.

Place the cursor in front of the level to be changed and Press **OK**. Move the cursor to **ON** and press **OK** to change the Password status from OFF to ON.

Entry is accomplished by scrolling through the alphanumeric list with the ▲ (forward →) and ▼ (backwards ←) arrows to the character of choice and then pressing **NEXT** to advance the cursor to the next digit. Pressing and holding the ▲ or ▼ keys will initiate two speed auto scrolling.

- **MENU** ON/OFF _____ Locks Main Menu
- **CAL** ON/OFF _____ Locks CAL and CONFIG
- **CONFIG** ON/OFF _____ Locks CONFIG
- **SIM** ON/OFF _____ Locks SIM and CONFIG



In the case of a **Lost or Forgotten Password** enter **MSTR** to access the screen.

Location: CONFIG → XMTR → PSSWD

4-20 mA Calibration Password "0000"

Location: CONFIG → XMTR → OUTPUT → 4-20 (1)(2) → MORE → CAL

4.0 CALIBRATION

Calibration must be performed for new installations. The PPA sensor The Model T80 transmitter provides three methods of calibration:

4.0.1 AUTO CALIBRATION DESCRIPTION

Auto calibration is the primary calibration method for all measurements. AUTO calibration automatically recognizes the calibration solution the sensor is in and proposes the actual temperature compensated value for acceptance. AUTO calibration can be a single point or two point calibration. A single point calibration sets the zero point or offset value of the sensor. The second calibration sets the slope or span of the sensor.

When the AUTO key is pressed and Cal 1 or Cal2 is selected the transmitter displays the PV (Process Variable) and the associated mV signal from the sensor. When the reading has stabilized a calibration value is Automatically proposed, i.e. 7.00 pH, 0.00 ppm Hydrogen Peroxide.

The user is prompted to accept the proposed calibration value or enter and accept another value. Once Cal 1 is accepted the user is ask to continue to Cal 2, yes/no. If yes, the sensor is moved to the second calibration solution and a second calibration value is proposed when the sensor has stabilized. Accept the value and the calibration is complete.

At the end of each calibration the Offset and Slope are displayed in the respective units, pH, mV, ppm, Press OK to save the calibration and write it to the sensor's memory.

4.0.2 STANDARDIZE CALIBRATION DESCRIPTION

A Standardize Calibration is a single point calibration where the transmitter's reading is adjusted to agree with a solution of known value, either a calibration standard, a grab sample or laboratory determined value. In many cases the constituents and the pressure and temperature of the process solution are very different from the calibration solution. In these cases, once the sensor has equilibrated to the process environment, the Zero Point or Offset value may have shifted from the original calibration point. Standardization allows for correction of this type of offset. It changes the Offset value in a pH calibration. **It changes the Slope value in a Hydrogen Peroxide calibration. It is the primary calibration for Hydrogen Peroxide Sensors.**

Enter the Hydrogen Peroxide value determined by a "grab sample" test with known ppm value of the process water. (can also use ECD Model HCA-1 Photometer Test Kit P/N 1000040-7 for this "grab sample" test).

When the STAND key is pressed, the user is prompted to ENTER VALUE. The user enters the pH or Hydrogen Peroxide value they want the transmitter to read and press OK. The user is then prompted to accept the value, yes/no, and the calibration is complete. Standardizations are single point calibrations.

At the end of each calibration the Offset and Slope are displayed in the respective units, pH, mV or ppm, Press OK to save the calibration and write it to the sensor's memory.



4.0.3 MANUAL CALIBRATION DESCRIPTION

Manual calibration allows the user to enter calibration data for an electrode into the transmitter without performing a calibration. A MANUAL Calibration requires the entry of three pieces of data, (1) A **concentration** with the (2) **corresponding mV** and (3) a **slope** for the electrode. This allows laboratory generated calibration data for an electrode to be entered in a remote analyzer where calibration is difficult or impractical.

The pictures show a Manual Calibration for a Hydrogen Peroxide sensor using the default values of 0.00 ppb = 0.00 mV and 8.0 nA/ppm.

Example: MANUAL Calibration for a pH electrode

1. Calibrate the pH electrode in the laboratory
2. Record the mV value of some pH Standard, pH 7.00 buffer = 6.8 mV (any pH – mV pair will work)
3. Calculate and Record the slope of the electrode, 58.2 mV/pH
4. Install the electrode into the field mounted sensor
5. **Press MANUAL** and enter the pH value, 7.00 pH, **press mV** and enter the corresponding mV value, 6.8 mV, **press OK**, Accept Offset?, **press YES**, enter slope 58.2 mV/pH, **press OK**, Accept Slope?, **Press YES**
6. The Calibration is complete, the Offset and Slope values are displayed, **press OK** to exit.

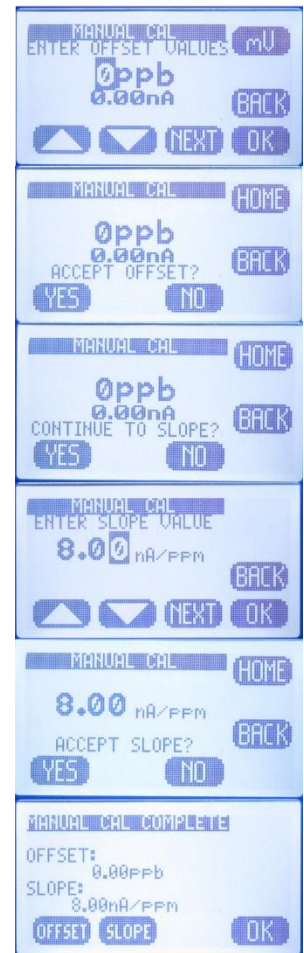

4.1 PH CALIBRATION PROCEDURES

AUTO Calibration recognizes pH 4.01, pH 7.00 and pH 10.00 buffer solutions for automatic, temperature compensated calibrations. Any calibration solutions can be used but the pH value will have to be entered manually. Follow the steps below to accomplish a pH calibration. Example uses pH 7.00 and pH 4.01 buffers.

4.1.1 AUTO CAL USING PH 4.01, 7.00, 10.00 BUFFERS

Action	Prompt
Double Press any Button	MENU HOME, Hold is OFF
Press HOLD	Hold freezes 4-20 mA Output and locks Alarm Relays during Calibration
Press CAL	Is this a new Sensor? (Yes erases CAL Log in INFO, NO adds CAL to existing Log)
Press Yes/NO	Place Sensor in CAL Solution (use pH 7.00 buffer)
Press AUTO then CAL 1	STABILIZING, 7.00 pH xx.x mV, 7.00 pH corrected Accept Cal 1?
Press YES	CAL1 Value 7.00 pH, Continue to CAL2? Move sensor to 4.01 pH buffer solution
Press YES	STABILIZING, 4.00 pH xxx.x mV, 4.00 pH corrected Accept Cal?
Press YES	OFFSET: 7.00 pH xx.x mV, SLOPE: 59.16 mV/pH (data written to Log)
Press OK	Calibration complete
Press HOME	Hold is ON
Press HOLD	Turn off Hold
Press EXIT	Main Display

4.1.2 AUTO CAL USING OTHER PH BUFFERS

Action	Prompt
Double Press any Button	MENU HOME, Hold is OFF
Press HOLD	Hold freezes 4-20 mA Output and locks Alarm Relays during Calibration
Press CAL	Is this a new Sensor? (Yes erases CAL Log in INFO, NO adds CAL to existing Log)
Press YES/NO	Place Sensor in CAL Solution
Press AUTO then CAL 1	STABILIZING, 6.86 pH 8.2 mV, 7.00 pH corrected Accept Cal?
Press NO	Enter CAL 1 Value
Press ▲ ▼ NEXT	6.86 pH (use arrows and NEXT to enter pH Buffer value)
Press OK	6.86 pH, 8.2 mV, Accept this Value
Press YES	CAL 1 Value 6.86 pH, Continue to CAL 2? (Place Sensor in 2 nd calibration buffer)
Press YES	STABILIZING, 9.18pH 135.6 mV, 10.00 pH corrected Accept Cal?
Press NO	Enter CAL 2 Value
Press ▲ ▼ NEXT	9.18 pH (use arrows and NEXT to enter pH Buffer value)
Press OK	9.18 pH, 135.6 mV, Accept this Value
Press YES	OFFSET: 6.86 pH 8.2 mV, SLOPE: 59.16 mV/pH (data written to Log)
Press OK	Calibration complete
Press HOME	Hold is ON
Press HOLD	Turn off Hold
Press EXIT	Main Display

4.1.3 STANDARDIZE

Leave the sensor in the process solution, take a grab sample from the process and determine the pH or place sensor in a calibration standard solution.

Action	Prompt
Double Press any Button	MENU HOME, Hold is OFF
Press HOLD	Hold freezes 4-20 mA Output and locks Alarm Relays during Calibration

Press CAL	Is this a new Sensor? (Yes, erases CAL Log in INFO, NO adds CAL to existing Log)
Press NO	Place Sensor in CAL Solution (or leave in the process solution)
Press STAND	Enter Value
Press ▲ ▼ NEXT	xx.xx pH (use arrows and NEXT to enter process pH value)
Press OK	xx.xx pH, xxx.x mV, Accept Value?
Press YES	OFFSET: xx.xx pH x.x mV, SLOPE: xx.xx mV/pH (this data written to Log)
Press OK	Back to Cal Menu
Press HOME	Hold is ON (Press HOLD to turn off Hold)
Press HOLD	Turn off Hold
Press EXIT	Main Display

4.2 HYDROGEN PEROXIDE CALIBRATION PROCEDURES

4.2.1 AUTO CAL

AUTO Calibration is an awkward calibration for the Hydrogen Peroxide sensor. It is the only way to enter the actual zero potential of the Hydrogen Peroxide sensor. The Slope calibration “Cal 2” is best accomplished in the Standardized menu, it is much easier and more straightforward.

AUTO Cal recognizes 0.00 ppm Hydrogen Peroxide solutions in Cal 1. The Zero point calibration is very consistent for a Hydrogen Peroxide sensor and should only be done after rebuilding or replacing the sensor. To perform a zero calibration either run Hydrogen Peroxide free water through the flow cell or remove the sensor from the flow cell and place it in a beaker of dechlorinated water. The zero point calibration will take about an hour for a new or rebuilt sensor. Most sensors will burn down to a value of 0.1-0.2 mV, at this point accept the calibration and proceed to Cal 2. Cal 2 sets the slope of the sensor. It is accomplished by setting the ppm value of the instrument to agree with a “grab sample” tested value of the water flowing through the HP80 Analyzer. The analyzer will suggest a corrected value of 0.00 ppm, 5.00 ppm or 10.00 ppm, which will not be correct unless that happens to be the actual value of the sample water, Press NO and enter the value from the “grab sample” test. The nominal value for the slope is 5.0 nA/ppm ± 2 nA.

Action	Prompt
Double Press any Button	MENU HOME, Hold is OFF
Press HOLD	Hold freezes 4-20 mA Output and locks Alarm Relays during Calibration
Press CAL	Is this a new Sensor? (Yes erases CAL Log in INFO, NO adds CAL to existing Log)
Press Yes/NO	Place TC Sensor in CAL 1 Solution (use 0.00 ppm solution)
Press AUTO then CAL 1	STABILIZING, 0.00 ppm, xxx.x nA, Accept Cal?
Press YES	CAL 1 Value 0.00 ppm, 0.2 nA, OK?
Press OK	Feed chlorinated water to the HP80, run “GRAB SAMPLE” test when the reading stabilizes. If the calibration times out and returns to the Home Screen, Press AUTO and select Cal 2.
Press YES	Continue to CAL2?
Press YES	STABILIZING, 2.25 ppm, 13.2 nA, 5.00 ppm corrected, Accept Cal?
Press NO	Enter Cal 2 Value, 2.25 ppm, Change value to the “GRAB SAMPLE” tested value, OK?
Press OK	OFFSET: 0.00 ppm, 0.2 nA, SLOPE: 5.86 nA/ ppm (data written to Log)
Press OK	Calibration complete
Press HOME	Hold is ON
Press HOLD	Turn off Hold
Press EXIT	Main Display

4.2.2 STANDARDIZE

The Standardize Calibration is the Primary method for calibrating the Hydrogen Peroxide sensor. It is the easiest and most straight forward method of calibration. Simply run a “GRAB SAMPLE” test and enter the value in the entry screen.

Action	Prompt
Double Press any Button	MENU HOME, Hold is OFF
Press HOLD	Hold freezes 4-20 mA Output and locks Alarm Relays during Calibration
Press CAL	Is this a new Sensor? (Yes, erases CAL Log in INFO, NO adds CAL to existing Log)
Press NO	Place Sensor in the process solution, Test sample with “GRAB SAMPLE”
Press STAND	Enter Value
Press ▲ ▼ NEXT	xxx.xx ppm (use arrows and NEXT to enter process value) OK?
Press OK	xxx.xx ppm, xxx.x nA, Accept Value?
Press YES	Current Value xx.xx, Desired Value xx.xx, Change xx.xx, OK?
Press OK	Back to Cal Menu
Press HOME	Hold is ON (Press HOLD to turn off Hold)
Press HOLD	Turn off Hold
Press EXIT	Main Display

4.2.3 MANUAL CAL

Manual Cal is a convenient way to reset the analyzer to default Status. Simply enter the actual zero point if it is known or 0.00 ppm = 00.0 nA and the default slope, 5 nA/ppm and the displayed value should be in the ballpark of the actual Hydrogen Peroxide value.

Action	Prompt
Double Press any Button	MENU HOME, Hold is OFF
Press HOLD	Hold freezes 4-20 mA Output and locks Alarm Relays during Calibration
Press CAL	Is this a new Sensor? (Yes, erases CAL Log in INFO, NO adds CAL to existing Log)
Press NO	Auto, Stand, Manual, Temp
Press MANUAL	Enter Zero Value
Press ▲ ▼ NEXT	0.00 ppm (use arrows and NEXT to enter ppm value)
Press OK	OFFSET: 0.00 ppm, 0.0 nA, Accept Value?
Press YES	Enter Slope, 5.00 nA/ppm
Press ▲ ▼ NEXT	5.00 nA/ppm
Press OK	Slope 5.00 nA/ppm, Accept this Value?
Press YES	Back to Cal Menu
Press HOME	Hold is ON (Press HOLD to turn off Hold)
Press HOLD	Turn off Hold
Press EXIT	Main Display

5.0 MAINTENANCE

The Model T80 transmitter requires no periodic maintenance, except to make sure the front window is kept clean in order to permit a clear view of the display and allow proper operation of the navigation buttons. If the window becomes soiled, clean it using a soft damp cloth or soft tissue. To deal with more stubborn stains, a neutral detergent or spray cleaner like Windex may be used. Never use harsh chemicals or solvents.

When you open the front cover and/or cable glands, make sure that the seals are clean and correctly fitted when the unit is re-assembled in order to maintain the housing's NEMA 4X weatherproof integrity against water and water vapor.

5.1 HYDROGEN PEROXIDE SENSOR

Check the measurement at regular intervals, at least once a month. If the membrane is visibly soiled clean it with a jet of water or a dilute HCl solution between 1-5%. Do not clean with detergents or solvents that would reduce the surface tension of the membrane.

Replacing the Membrane Cap (PN 1000267-1)

Filling the membrane cap

The sensor is delivered with the membrane cap with G-Holder loosely screwed on the electrode shaft. Pull the transparent protection cap off the membrane cap and unscrew the membrane cap.

Place the membrane cap onto a clean base. Fill up the membrane cap up to the edge with the enclosed electrolyte, empty it out and refill again up to the edge.

When replacing the membrane cap with a new membrane cap the G-Holder must be inserted into the cap.

Place the G-Holder on a clean hard surface and fill it with electrolyte.

Mount the G-Holder in the middle of membrane cap with the supplied tweezers.

Insert the G-holder with the tweezers into a filled membrane cap. Place the G-holder at the bottom middle of the membrane cap. Then remove the tweezers carefully. The G-holder stays in the membrane cap. Screw the sensor body into the membrane cap so that the cathode is inside the G-Holder. Continue to tighten until the red o-ring is completely compressed.



Refilling the Sensor

Refill the sensor with electrolyte every six months or sooner depending on the ozone level measured. Refill every 3-4 months for levels in the upper 75% area of the range and at every membrane change.

Unscrew the measuring chamber from the sensor and pour out the spent solution.

Fill the chamber to approximately 0.4 in / 1 cm from the top and tap it gently to dislodge any trapped bubbles inside the chamber. Do not remove the G-Holder

Screw the measuring chamber vertically back onto the sensor ensuring all air inside the chamber is displaced with liquid.

When the o-ring begins to seal continue slowly tightening until the stop.

The sensor is ready to use, re-polarize the sensor for 60 minutes and recalibrate as described above.

Storage

The method for Storage of the sensor is dependent on time.

For short term storage of several weeks the sensor can be stored filled inside the yellow protective cap as long as the membrane is not allowed to dehydrate. Make sure the sponge inside the cap is wetted. For longer terms rinse out the electrolyte with distilled water and allow the sensor to dry. Loosely reassemble the dry sensor so as not to tension the membrane during storage.

5.2 PH SENSOR

All electrochemical sensors require periodic cleaning and/or replacement. The life of an electrode is dependent on the process conditions it is exposed to, a pH electrode may last a year or longer in potable water and only a few weeks in a hot caustic bath. The chemical constituents in the process may coat the electrode surfaces requiring the electrode to be removed and cleaned or replaced.

Cleaning agents should be specific to the type of coating, detergents and alcohols for removing greases and oils, acids for removing hard water scales and metallic deposits or spray washing for flocculants and biofilms.

5.2.1 ELECTRODE CARTRIDGE INSTALLATION

Unless ordered separately, electrode cartridges are generally shipped installed in a sensor. Sensors ordered without an electrode are shipped with a shipping plug to keep contamination from getting inside the sensor during shipment or storage. The following procedure explains how to install the electrode cartridge in the sensor assembly:

1. Remove the shipping plug by turning it counterclockwise.
2. Remove the electrode cartridge from the protective soaker boot. *Be careful not to flex the electrode body while removing the tape and the protective boot.*
3. Rinse the electrode tip in tap water and wipe the electrode body dry then lubricate the o-ring seals with the included lubricant. *Save the protective soaker boot in the event the electrode must be stored at a future time.*
4. Carefully insert the electrode cartridge into the sensor assembly by turning until **hand tight**. The first o-ring, closest to the front of the electrode, will be slightly visible if held horizontally.

NOTE: IF EXCESS FORCE IS REQUIRED DURING ELECTRODE INSTALLATION, CHECK FOR PROPER THREAD ENGAGEMENT OR FOR AN OBSTRUCTION.

5.2.2 ELECTRODE CARTRIDGE REPLACEMENT

Periodic replacement of the electrode cartridge is required for pH, ORP and Specific Ion sensors. The following procedure explains how to replace the electrode cartridge in the sensor assembly:

2. Remove the electrode cartridge from the front of the sensor assembly by turning it counterclockwise.
3. For installation procedure follow steps 2, 3, and 4 in section 5.2.1 electrode cartridge installation.

5.2.3 ELECTRODE CLEANING

An important aspect of sensor maintenance is the service of the electrode cartridge. After being in operation, an electrode may begin to exhibit slow response or non-reproducible measurements. This may be due to coating of the measurement electrode or clogging of the reference junction. Regular electrode cleaning reduces problems associated with the coating and clogging. Frequency of cleaning will depend on the process and application. The following procedures are used to clean pH and ORP electrodes.

If possible, the electrode should be cleaned without removing it from the sensor body. However, if the electrode must be removed, the o-rings must be inspected and re-lubricated.

5.2.4 PH ELECTRODE CARTRIDGE CLEANING

Remove the sensor from the process and carefully wash the wetted end of the electrode cartridge in a mild solution of detergent and water or with methyl alcohol. If the electrode response is not improved, soak the electrode in 0.1 Molar HCl for 5 minutes. Remove and rinse the electrode with tap water and soak in 0.1 Molar NaOH for 5 minutes.

Remove the electrode from the NaOH solution, rinse the electrode with copious amounts of tap water and soak in a 4 pH buffer solution for 10 minutes. This should improve the response of the electrode. If not, replace the electrode.

If the electrode must be left out of the process for an extended period of time, store it in a solution of water saturated with KCl or a 4.0 pH buffer solution. *ECD does not recommend the storage of electrodes in distilled or deionized water.*

5.3 CONSTANT HEAD FLOW CONTROLLER (CHFC)

The CHFC is designed to provide a constant flow to the Free Hydrogen Peroxide Sensor (FCS) independent of variations in the sample pressure. Decreasing the sample flow to the FCS will lower the output of the FCS. In most clean water applications the CHFC requires no maintenance. The vertical position of the central tube sets the Head Pressure of the system. It is set for optimal flow but lower flow rates can be attained by adjusting its height.

On a monthly basis visually inspect the CHFC, the interconnecting tubing and the drain tubing for obstructions or sediments that may reduce the flow. The CHFC and tubing can be easily disassembled and cleaned with soap and water. Some dirty applications like Cooling Towers may require periodic cleaning due to sediments.

6.0 TROUBLESHOOTING

The HP80 was evaluated and calibrated at the factory before shipment. Upon initial start up the system should require minimal to no adjustments.

Verify the system has adequate flow, greater than 10 gals /hr., the pH electrode and the temperature sensor are reading correctly. These parameters effect the measurement and must meet the standards listed in the Calibration Section above. If these conditions are met and problems still exist use the Troubleshooting Table to find a remedy.

Troubleshooting Guide

Symptom	Possible Cause	Remedy
Displayed value is Higher than "GRAB SAMPLE" test value.	Insufficient Polarization time	Polarize HPS for full 90 minutes before calibration.
	Damaged Membrane Cap	Replace Membrane Cap
	pH indication higher than actual value	Calibrate pH sensor
	Temperature indication lower than actual value	The temperature sensor lags the process temperature wait for temperature equilibrium.
Displayed value is Lower than "GRAB SAMPLE" test value	Electrical short or wet connection inside the sensor or cable assembly	Remove measuring cap and dry the cathode surface, if the indication does not go to zero there is leakage. Replace the sensor.
	Coated or dirty membrane	Clean or replace the membrane
	Low tension on the membrane	Verify the Measuring Chamber is fully tightened onto the body or replace membrane.
	Flow to low through the flow cell	Clean CHFC, fittings and tubing, verify the sample feed rate is 10+ gal/hr.
Displayed value is Lower than "GRAB SAMPLE" test value	Air bubbles trapped on membrane	Loosen HPS fitting and lift sensor slightly to purge air trapped in the flow cell.
	Air bubble inside the sensor between cathode and	Refill sensor, see Maintenance

(cont'd)	<p>membrane</p> <p>pH indication lower than actual value</p> <p>Temperature indication is higher than actual value.</p>	<p>Calibrate pH sensor</p> <p>Calibrate the Temperature (see Calibration) The temperature sensor lags the process temperature wait for temperature equilibrium.</p>
Zero Hydrogen Peroxide Reading	<p>No electrolyte in the sensor</p> <p>Open Circuit on FCS, broken or bad electrical connection</p>	<p>Refill Sensor</p> <p>Check connector and wiring to the connector inside the T80</p>
Unstable Hydrogen Peroxide Reading	<p>Air bubbles on the membrane</p> <p>Changing temperature, the lag of the temperature sensor looks like drift</p>	<p>Loosen HPS fitting and lift sensor slightly to purge air trapped in the flow cell.</p> <p>Wait for equilibrium</p>
Green LED flickering or no light	<p>Supply Voltage to low</p> <p>Defective Sensor</p>	<p>Verify 24V DC between the Blue and White sensor wires</p> <p>Return sensor to the manufacturer for reconditioning</p>
Orange LED, Continuously ON Flickering	<p>Wrong Polarity on signal wires</p> <p>Hydrogen Peroxide concentration to high, sensor over range</p>	<p>Verify Black #3, Yel/Grn #2</p> <p>Check for torn membrane, verify Hydrogen Peroxide concentration, Recalibrate the sensor</p>

7.0 PARTS AND ACCESSORIES

7.1 HP80 REPLACEMENT PARTS

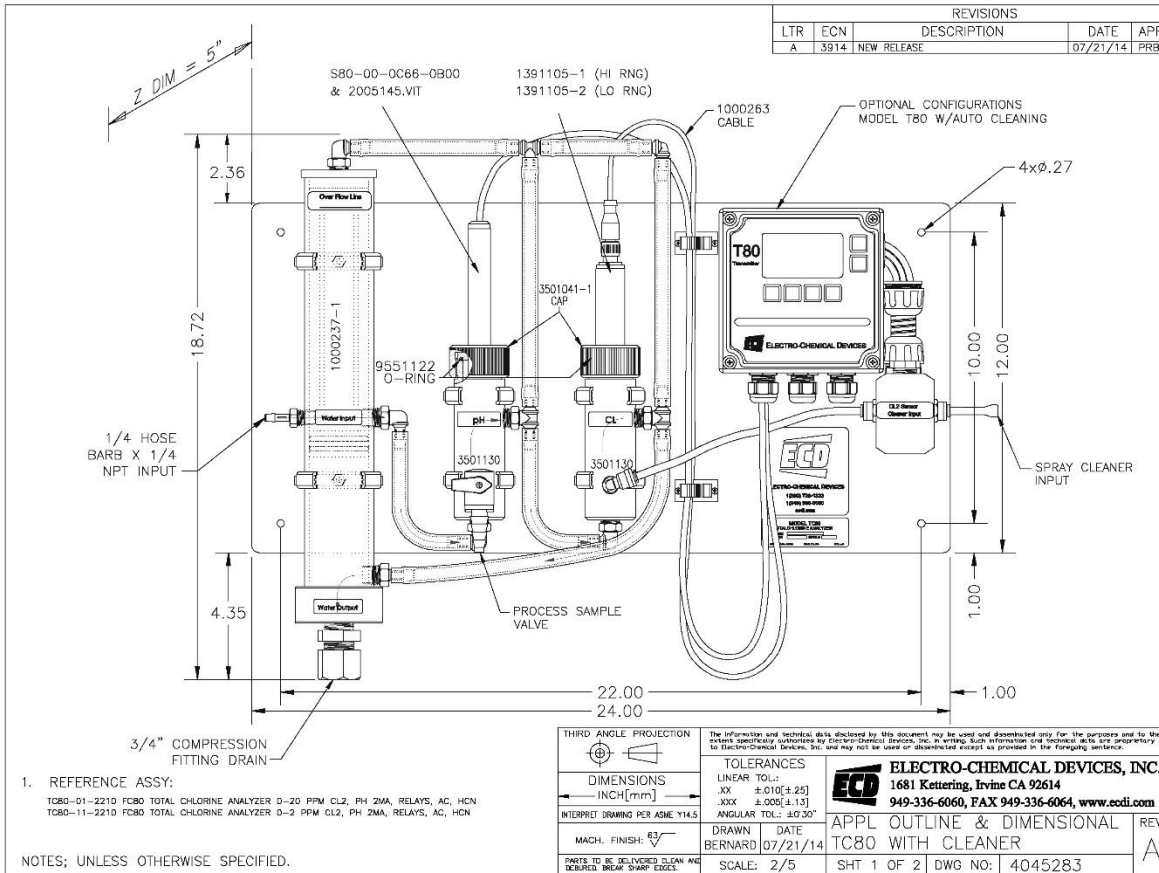

Part #	Description
1391115-1	Hydrogen Peroxide Sensor, 0 – 200 ppm
1000267-1	HP Membrane Replacement Kit (1 membrane Cap, 100 ml bottle of electrolyte)
2005145.VIT	pH replacement electrode cartridge
S80-00-0C66-0B00	pH Sensor, 316L SS body with Flange, 4' cable
3501131	Hydrogen Peroxide Flow Cell
3501130	pH Flow Cell
3501041-1	Flow Cell Threaded Cap
1000260-2	Sunshield for Rail Mount
1000237-1	Constant Head Flow Controller
1000250-1	Tube Fitting Set, complete set (9) 3/8" fittings (1) 1/4" fitting
5000714-X	3/8" tubing Food Grade PVC, (X) = ft., FC80 uses 4.5 ft.

7.2 T80 FRONT PANEL CONTROL BOARD EXPLODED

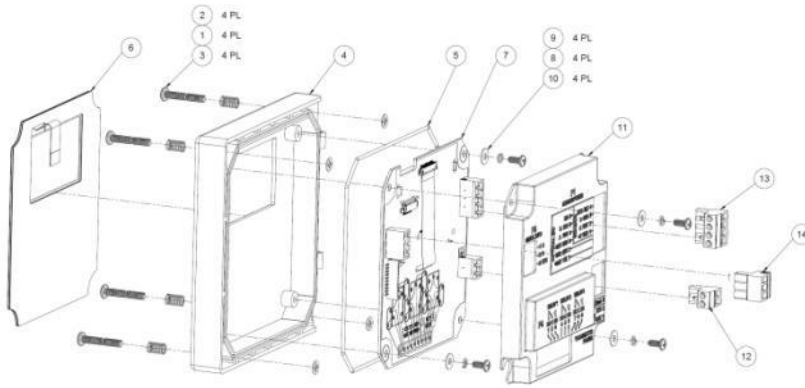

7.3 T80 FRONT PANEL CONTROL BOARD EXPLODED, WITH RELAYS

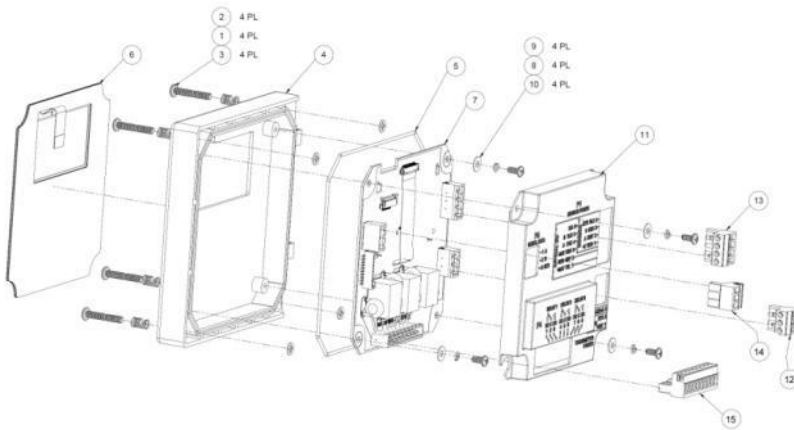

Item #	Part #	Description
1	9630005	Spring, Mounting Screw Set
2	9870621	Retaining Washer, Mounting Screw Set
3	3600390	8-32 x 1" SS Screw, Mounting Screw Set
4	3400152	Front Housing
5	9560005	Sealing O-ring, grey silicone
6	9240503-1	Touch pad membrane
7	2101800-1	PCB, Control Board, Loop Powered
7	2101800-2	PCB, Control Board, Loop Powered, Relays
7	2101800-3	PCB, Control Board, Loop Powered, HART
8	9870650	Locking Washer, PCB Screw Set
9	9730905	6-32 x 5/16" SS Screw, PCB Screw Set
10	9870620	Flat Washer, PCB Screw Set
11	3400006-1	Control Board Cover
12	9090112	24 VDC, 4-20 mA Terminal Block/2 pins
13	9090114	Sensor Terminal Block/4 pins
14	9090113	Serial connection Terminal Block/3 pins
15	9090119	Relay Connection Terminal Block/9 pins

7.4 T80 TRANSMITTER CASE, BACK WITH CABLE GLANDS

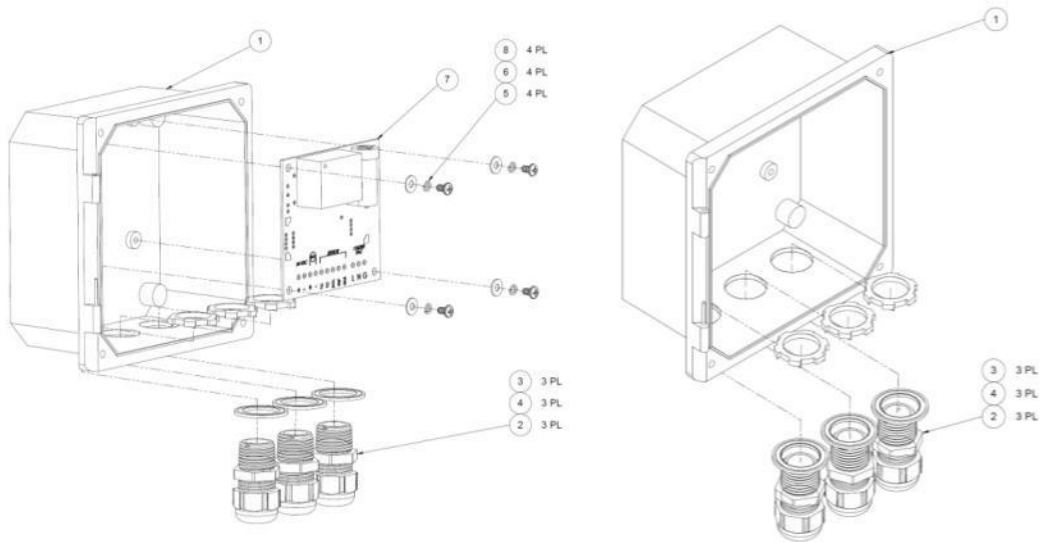

Item #	Part #	Description
1	3600449	Transmitter Case
2	9360005	PVC Cable Gland, ½" NPT, Grey
3	9300034	Locking Nut, ½" NPT, Steel
4	9300017	Sealing ring, ½" elastomer
5	9870650	Split Washer, PS mounting
6	9870620	Flat Washer, PS mounting
7	2101820-1	Power Supply Board
8	9730604	6-32 x ¼" screw, SS, PS mounting

7.5 T80 REPLACEMENT PARTS

Part #	Description
2000002-1	Front Panel, Loop-Powered
2000002-2	Front Panel, AC/DC Powered
2000002-3	Front Panel, Loop-Powered, Hart Output
2101820-1	Power Supply Board, 110/220 VAC Input
2101820-3	Power Supply Board, 110/220 VAC Input, w/preamp
2101820-4	Preamp Board
3400006	Control Board Cover
9090112	Connector Plug, 2 Position (Loop, AC/DC, or Hart Versions)
9090113	Connector Plug, 3 Position (Loop or AC/DC Versions)
9090114	Connector Plug, 4 Position (Loop, AC/DC or Hart Versions)
9090119	Connector Plug, 9 Position (AC/DC Version)
9240503-1	Front Panel Membrane Switch
9300017	Sealing ring, Cable Gland
9300034	Locking Nut, Cable Gland
9360005	Fitting, Cable Gland
9830214	Screw, Front Panel

APPENDIX

A. AUTO CAL BUFFER TABLES

°C	pH	pH	pH
0	4.00	7.115	10.32
5	4.00	7.085	10.25
10	4.00	7.06	10.18
15	4.00	7.04	10.12
20	4.00	7.015	10.06
25	4.005	7.00	10.01
30	4.015	6.985	9.97
35	4.025	6.98	9.93
40	4.03	6.975	9.89
45	4.045	6.975	9.86
50	4.06	6.97	9.83
55	4.075	6.97	
60	4.085	6.97	
65	4.10	6.98	
70	4.13	6.99	
75	4.14	7.01	
80	4.16	7.03	
85	4.18	7.05	
90	4.21	7.08	

B. MODBUS RTU REGISTER LISTING

03 (0X03) READ HOLDING REGISTERS

This function code is used to read the contents of a contiguous block of holding registers in a remote device. The Request Protocol Data Unit specifies the starting register address and the number of registers. In the Protocol Data Unit Registers are addressed starting at zero. Therefore registers numbered 1-16 are address as 0-15.

The register data in the response message are packed as to bytes per register, with the binary contents right justified within each byte. For each register, the first byte contains the high order bits and the second contains the low order bits.

Request

Modbus ID (Slave Address)	1 Byte	1 to 247 (0x01 to 0xF7)
Function code	1 Byte	0x03
Starting Address	2 Bytes	0x0000 to 0xFFFF
Quantity of Registers	2 Bytes	1 to 125 (0x01 to 0x7D)
CRC	2 Bytes	calculated

Response

Modbus ID (Slave Address)	1 Byte	1 to 247 (0x01 to 0xF7)
Function code	1 Byte	0x03
Byte Count	1 Byte	2 X N*
Register Value(s)	*N X 2 Bytes	

CRC	2 Bytes	calculated
*N = Quantity of Registers		

Error

Modbus ID (Slave Address)	1 Byte	1 to 247 (0x01 to 0xF7)
Error Code	1 Byte	0x86
Exception Code	1 Byte	01, 02, 03 or 04
CRC	2 Bytes	calculated

06 (0x06) WRITE SINGLE REGISTER

This function code is used to write a single holding register in a remote device.

The Request Protocol Data Unit specifies the address of the register to be written. Registers are addressed starting at zero. Therefore register number 1 is addressed as 0.

The normal response is an echo of the request, returned after the register contents have been written.

Request

Modbus ID (Slave Address)	1 Byte	1 to 247 (0x01 to 0xF7)
Function code	1 Byte	0x06
Register Address	2 Bytes	0x0000 to 0xFFFF
Register Value	2 Bytes	0x0000 to 0xFFFF
CRC	2 Bytes	calculated

Response

Modbus ID (Slave Address)	1 Byte	1 to 247 (0x01 to 0xF7)
Function code	1 Byte	0x06
Register Address	2 Bytes	0x0000 to 0xFFFF
Register Value	2 Bytes	0x0000 to 0xFFFF
CRC	2 Bytes	calculated

*N = Quantity of Registers

Error

Modbus ID (Slave Address)	1 Byte	1 to 247 (0x01 to 0xF7)
Error Code	1 Byte	0x86
Exception Code	1 Byte	01, 02, 03 or 04
CRC	2 Bytes	calculated

REGISTERS

Per the Modbus Application Protocol Specification (V1.1b)

Name	Meaning (2 bytes each register)	Number of Registers	Return Data Format	Read Write	Requires Storage Initiate	Register #	
						dec	hex
Modbus ID (slave address)	Defined as 1 to 247 per the Modbus Application Protocol Specification (V1.1b)	1	16 bit Integer	RW		0	00
Data Format	Data Format of the User Bus to the T80 (0-DF8N2, 1-DF8O1, 2-DF8E1, 3-DF8N1)	1	16 bit Integer	RW		1	01
Baud Rate	Baud Rate of the User Bus to the T80 (0-1200, 1-2400, 2-4800, 3-9600)	1	16 bit Integer	RW		2	02
BusMessage	total message count detected by the slave (remote device)	1	16 bit Integer	R		3	03
BusCommunicationsError	total CRC error count	1	16 bit Integer	R		4	04

SlaveExceptionError	total count of exceptions detected	1	16 bit Integer	R		5	05
SlaveMessage	total messages addressed to the slave (remote device)	1	16 bit Integer	R		6	06
SlaveNoResponse	total count of messages not responded to by the slave (remote device)	1	16 bit Integer	R		7	07
SlaveNAK	total Negative Acknowledges returned by slave (remote device)	1	16 bit Integer	R		8	08
SlaveBusy	total count of "slave busy" was returned for an address message	1	16 bit Integer	R		9	09
BusCharacterOverrun	count of messages that couldn't be handled due to character over-run condition	1	16 bit Integer	R		10	0A
Reset all Modbus Error Counters	Resets all of the Modbus Error counters (defined in Modbus spec) to 0, Write any value.	1	16 bit Integer	W		11	0B
Product T80 Model Number (Modbus)	The Model Number of the Unit polled	1	16 bit Integer	R		12	0C
T80 Serial Number (hi word)	Unit Serial Number (32 bit integer hi word, bytes 3 and 2)	2	32 bit Long Integer	R		13	0D
T80 Serial Number (lo word)	Unit Serial Number (32 bit integer lo word, bytes 1 and 0)					14	0E
T80 Mode	Unit operating mode (1-Startup, 2-Sensor Search, 3-Operate)	1	16 bit Integer	R		15	0F
T80 Fault Status	Unit Fault flags, bit defined	1	16 bit Integer	R		16	10
T80 2nd Fault Status	Unit Fault flags (2nd word reserved, currently not used)	1	16 bit Integer	R		17	11
T80 Warning Status	Unit Warning flags, bit defined	1	16 bit Integer	R		18	12
T80 2nd Warning Status	Unit Warning flags (2nd word reserved, currently not used)	1	16 bit Integer	R		19	13
T80 FW Rev	Firmware revision of the Control BD in ASC, ex. " 1".	1	16 bit Integer	R		20	14
Relay Number to read/write	Relay number to access data (0 - Relay 1, 1 - Relay 2, 2 - Relay 3)	1	16 bit Integer	RW		21	15
Relay Type	Read/Write Relay Type (0 - Fault Type, 1 - Alarm Type, 2 - Disabled, 3 - Timed)	1	16 bit Integer	RW	Y	22	16
Relay ON Setpoint (hi word)	Read/Write Relay ON Setpoint (byte 3 and byte 2)	2	32 bit Floating Point	RW	Y	23	17
Relay ON Setpoint (lo word)	Read/Write Relay ON Setpoint (byte 1 and byte 0)					24	18
Relay OFF Setpoint (hi word)	Read/Write Relay OFF Setpoint (byte 3 and byte 2)	2	32 bit Floating Point	RW	Y	25	19
Relay OFF Setpoint (lo word)	Read/Write Relay OFF Setpoint (byte 1 and byte 0)					26	1A
Relay ON Delay (hi word)	Read/Write Relay turn on Delay time (byte 3 and byte 2)	2	32 bit Floating Point	RW	Y	27	1B
Relay ON Delay (lo word)	Read/Write Relay turn on Delay time (byte 1 and byte 0)					28	1C
Relay OFF Delay (hi word)	Read/Write Relay turn off Delay time (byte 3 and byte 2)	2	32 bit Floating Point	RW	Y	29	1D
Relay OFF Delay (lo word)	Read/Write Relay turn off Delay time (byte 1 and byte 0)					30	1E
Relay Energized State	Read/Write Relay 0 - Energized, 1 - De-Energized	1	16 bit Integer	RW	Y	31	1F
Relay Expiration	Read/Write Expiration Time, used with alarm type (0 - None, 2 - 5min., 3 - 10min., 4 - 15min., 6 - 30min.)	1	16 bit Integer	RW	Y	32	20
Relay Period	Read/Write Timed Relay Period (0 - 15min., 1 - 30min., 2 - 1hr., 3 - 2hr., 4 - 4hr., 5 - 8hr., 6 - 24hr.)	1	16 bit Integer	RW	Y	33	21
Relay Duration	Read/Write Timed Relay Duration (0 - 15sec., 1 - 30sec., 2 - 1min., 3 - 2min., 4 - 5min., 5 - 15min., 6 - 10min.)	1	16 bit Integer	RW	Y	34	22

Relay Hold Time	Read/Write Timed Relay Hold Time (0 - Off, 1 - held for the duration time, 2 - duration + 15sec., 3 - duration + 30sec., 4 - duration + 1min., 5 - duration + 2min., 6 - duration + 5 min., 7 - duration + 15min., 8 - duration + 30min.)	1	16 bit Integer	RW	Y	35	23
4-20 mA Channel Number to read/write	4-20 mA channel number to access data (0 - 1st 4-20mA, 1 - 2nd 4-20)	1	16 bit Integer	RW	Y	36	24
4-20 Analog Type	Read/Write 4-20 Type (0 - Range, 1 - Temperature, 2 - Sentinel)	1	16 bit Integer	RW	Y	37	25
4-20 Analog Range, 4mA range (hi word)	Read/Write 4mA range (bytes 3 and 2) applies to both range and temperature types	2	32 bit Floating Point	RW	Y	38	26
4-20 Analog Range, 4mA range (lo word)	Read/Write 4mA range (bytes 1 and 0) applies to both range and temperature types					39	27
4-20 Analog Range, 20mA range (hi word)	Read/Write 4mA range (bytes 3 and 2) applies to both range and temperature types	2	32 bit Floating Point	RW	Y	40	28
4-20 Analog Range, 20mA range (lo word)	Read/Write 4mA range (bytes 1 and 0) applies to both range and temperature types					41	29
Long Tag Line number to read/write	Tag Line number to access data (0 - Line 1, 1 - Line 2)	1	16 bit Integer	RW	Y	42	2A
Long Tag Line 1 (16 characters max)	ASCII character bytes 0 and 1, ex. "AB" A - 65 (41 hexadecimal), B - 66 (42 hex), send 6566 (4142 hex). The characters permitted are space ' ' (32 base 10, 20 hex) through '}' 125 base 10, 7D hex).	1	16 bit Integer	RW	Y	43	2B
Long Tag Line	ASCII bytes 2 and 3	1	16 bit Integer	RW	Y	44	2C
Long Tag Line	ASCII bytes 4 and 5	1	16 bit Integer	RW	Y	45	2D
Long Tag Line	ASCII bytes 6 and 7	1	16 bit Integer	RW	Y	46	2E
Long Tag Line	ASCII bytes 8 and 9	1	16 bit Integer	RW	Y	47	2F
Long Tag Line	ASCII bytes 10 and 11	1	16 bit Integer	RW	Y	48	30
Long Tag Line	ASCII bytes 12 and 13	1	16 bit Integer	RW	Y	49	31
Long Tag Line	ASCII bytes 14 and 15	1	16 bit Integer	RW	Y	50	32
Initiate T80 Parameter Storage	Signals the user has completed entering the data and wants it stored. Write any value.	1	16 bit Integer	RW		51	33
Sensor Channel to read/write	Sensor channel number to access data (0 - Sensor 1, 1 - Sensor 2)	1	16 bit Integer	RW		52	34
S80 Mode	Unit operating mode (0-	1	16 bit Integer	R		53	35
S80 Serial Number (hi word)	Unit Serial Number (32 bit integer hi word)	2	32 bit Long Integer	R		54	36
S80 Serial Number (lo word)	Unit Serial Number (32 bit integer lo word)					55	37
S80 Fault Status		1	16 bit Integer	R		56	38
S80 Sensor Type	Specific S80 sensor type (see S80 Sensor Types tab)	1	16 bit Integer	R		57	39
S80 Sensor Chemical Type	Specific chemicals the S80 is set to detect (see S80 Sensor Types tab)	1	16 bit Integer	RW	Y	58	3A
S80 Max Range (hi word)	Max sensor range (bytes 3 and 2)	2	32 bit Floating Point	R		59	3B
S80 Max Range (lo word)	Max sensor range (bytes 1 and 0)					60	3C
S80 Min Range (hi word)	Min sensor range (bytes 3 and 2)	2	32 bit Floating Point	R		61	3D
S80 Min Range (lo word)	Min sensor range (bytes 1 and 0)					62	3E
S80 Sensor Value (hi word)	Current sensor value (bytes 3 and 2)	2	32 bit Floating Point	R		63	3F
S80 Sensor Value (lo word)	Current sensor value (bytes 1 and 0)					64	40
S80 Sensor Voltage (hi word)	Corresponding sensor voltage to the sensor value (byte 3 and byte 2)	2	32 bit Floating Point	R		65	41

S80 Sensor Voltage (lo word)	Corresponding sensor voltage to the sensor value (byte 1 and byte 0)	2	32 bit Floating Point	R		66	42
S80 Sensor Temperature (hi word)	Sensor Temperature (bytes 3 and 2)	2	32 bit Floating Point	R		67	43
S80 Sensor Temperature (lo word)	Sensor Temperature (bytes 1 and 0)					68	44
S80 Sensor is a Sentinel	Sensor is a Sentinel Type (0 - No, 1 - Yes)	1	16 bit Integer	R		69	45
S80 Sentinel Life %	% of Sensor life remaining	1	16 bit Integer	R		70	46
S80 Sentinel Vs (hi word)	Scaled Sentinel Voltage (in mV) normalized to Vo (bytes 3 and 2)	2	32 bit Floating Point	R		71	47
S80 Sentinel Vs (lo word)	Scaled Sentinel Voltage (in mV) normalized to Vo (bytes 1 and 0)					72	48
S80 Sentinel Vo (hi word)	Sentinel 100% value (in mV) on the life relative to 0V (bytes 3 and 2)	2	32 bit Floating Point	RW	Y	73	49
S80 Sentinel Vo (lo word)	Sentinel 100% value (in mV) on the life relative to 0V (bytes 1 and 0)					74	4A
S80 Sentinel Range (hi word)	Sentinel Range (bytes 3 and 2)	2	32 bit Floating Point	RW	Y	75	4B
S80 Sentinel Range (lo word)	Sentinel Range (bytes 1 and 0)					76	4C
Sensor Full Name (18 characters max)	ASCII character bytes 0 and 1, ex. "AB" A - 65 (41 hexadecimal), B - 66 (42 hex), send 6566 (4142 hex). The characters permitted are space ' ' (32 base 10, 20 hex) through '}' 125 base 10, 7D hex).	1	16 bit Integer	RW	Y	77	4D
Sensor Full Name	ASCII bytes 2 and 3	1	16 bit Integer	RW	Y	78	4E
Sensor Full Name	ASCII bytes 4 and 5	1	16 bit Integer	RW	Y	79	4F
Sensor Full Name	ASCII bytes 6 and 7	1	16 bit Integer	RW	Y	80	50
Sensor Full Name	ASCII bytes 8 and 9	1	16 bit Integer	RW	Y	81	51
Sensor Full Name	ASCII bytes 10 and 11	1	16 bit Integer	RW	Y	82	52
Sensor Full Name	ASCII bytes 12 and 13	1	16 bit Integer	RW	Y	83	53
Sensor Full Name	ASCII bytes 14 and 15	1	16 bit Integer	RW	Y	84	54
Sensor Full Name	ASCII bytes 16 and 17	1	16 bit Integer	RW	Y	85	
Sensor Abbreviated Name (8 characters max)	ASCII character bytes 0 and 1, ex. "AB" A - 65 (41 hexadecimal), B - 66 (42 hex), send 6566 (4142 hex). The characters permitted are space ' ' (32 base 10, 20 hex) through '}' 125 base 10, 7D hex).	1	16 bit Integer	RW	Y	86	56
Sensor Abbreviated Name	ASCII bytes 2 and 3	1	16 bit Integer	RW	Y	87	57
Sensor Abbreviated Name	ASCII bytes 4 and 5	1	16 bit Integer	RW	Y	88	58
Sensor Abbreviated Name	ASCII bytes 6 and 7	1	16 bit Integer	RW	Y	89	59
Initiate S80 Storage	Signals the user has completed entering the data and wants it stored. Write any value.	1	16 bit Integer	W		90	5A
Cal log number to read	Cal log number to read (0 - Cal Log 1, 1 - Cal Log 2, 2 - Cal Log 3)	1	16 bit Integer	RW		91	5B
S80 Cal Log slope (hi word)	(bytes 3 and 2)	2	32 bit Floating Point	R		92	5C
S80 Cal Log slope (lo word)	(bytes 1 and 0)					93	5D
S80 Cal Log offset (hi word)	(bytes 3 and 2)	2	32 bit Floating Point	R		94	5E
S80 Cal Log offset (lo word)	(bytes 1 and 0)					95	5F
S80 Cal Log offset Voltage (hi word)	(bytes 3 and 2)	2	32 bit Floating Point	R		96	60
S80 Cal Log offset Voltage (lo word)	(bytes 1 and 0)					97	61

FAULT STATUS

Bit #	bit meaning
0	Memory Error, either a Program Flash, RAM or NVM RAM checksum error has occurred
1	Input Voltage Out Of Tolerance
2	The On Board +12V is Out of Tolerance
3	The On Board +3.3V is Out of Tolerance
4	The Transmitter has lost communication link with the Sensor
5	There is no Sensor connected
6	Sensor Calibration Failed
7	Relay 1 on-time expired
8	Relay 2 on-time expired
9	Relay 3 on-time expired
10	Sentinel Error (useable life has expired)
11	Sentinel Poisoned
12	Membrane Error
13	NU
14	NU
15	NU

WARNING STATUS

Bit #	bit meaning
0	The Sensor has changed from previously connect Sensor
1	Not Used (NU)
2	NU
3	NU
4	NU
5	NU
6	NU
7	NU
8	NU
9	NU
10	NU
11	NU
12	NU
13	NU
14	NU
15	NU

SENSOR TYPE

Data		Meaning		
Decimal	Hexadecimal	Chemical	Sensor Type	Measurement Units
0	0000	Unknown Chemical	None	None
1	0001	Ammonia	mV	ppm
2	0002	Ammonium	mV	ppm
3	0003	Bromide	mV	ppm
4	0004	Calcium	mV	ppm
5	0005	Chloride	mV	ppm
6	0006	Conductivity	Conductivity	S
7	0007	Cupric	mV	ppm
8	0008	Cyanide	mV	ppm
9	0009	DO	mV	ppm
10	000A	DO	mV	% saturation
11	000B	DO	mV	mg/L

12	000C	Fluoride	mV	ppm
13	000D	Hardness (CaCO ₃)	mV	ppm
14	000E	Nitrate	mV	ppm
15	000F	ORP	mV	mVa
16	0010	pH	mV	none
17	0011	Potassium	mV	ppm
18	0012	Resistivity	Conductivity	Ohm (W)
19	0013	Silver	mV	ppm
20	0014	Sodium	mV	ppm
21	0015	Sulfide	mV	ppm
22	0016	Turbidity	TR6	FNU
23	0017	Turbidity	TR6	NTU
24	0018	Turbidity	TR6	ppm
25	0019	Turbidity	TR6	mg/L
26	001A	Turbidity	TR6	% solid
27	001B	DO	DO80	ppm
28	001C	DO	DO80	% saturation
29	001D	DO	DO80	mg/L
30	001E	Calcium	mV	mg/L
31	001F	TDS	Conductivity	ppm
32	0020	Nitrite	mV	ppm
33	0021	TC (max range)	TC80	mg/L
34	0022	TC (min range)	TC80	mg/L
35	0023	FC (max range)	FC80	mg/L
36	0024	FC (min range)	FC80	mg/L
37	0025	FC(200ppm range)	FC80 High	mg/L
38	0026	Resistivity	Conductivity	Ohm
39	0027	Conductivity	Resistivity	S
40	0028	Hydrogen Peroxide	HP80	0 to 2000 ppm
41	0029	Lead	mV	ppm
42	002A	Salinity	Conductivity	PSU
43	002B	Ozone	OZ80	0 to 2 ppm
44	002C	Ozone	OZ80	0 to 20 ppm
45	002D	Peracetic Acid	PA80	0 to 200 ppm
46	002E	Peracetic Acid	PA80	0 to 2000 ppm
47	002F	Peracetic Acid	PA80	0 to 2% v/v
48	0030	Peracetic Acid	PA80	0 to 20% v/v
49	0031	Hardness	mV	Grains
50	0032	Sulfuric Acid	Toroidal	< 30%
51	0033	Sulfuric Acid	Toroidal	30% to 85%
52	0034	Sulfuric Acid	Toroidal	> 85%
53	0035	Hydrogen Peroxide	HP80	0 to 200 ppm

54	0036	Hydrogen Peroxide	HP80	0 to 20000 ppm
55	0037	Nickel	Nickel Opt	0 to 70000 ppm

C. AUTO SPRAY CLEANER

The HP80 is available with an automatic spray cleaner. The cleaning cycle is controlled by Alarm Relay 1 which is configured as a TIMED relay. The default settings are a 12 hour period, 30 second duration and the HOLD function ON for the duration plus 1 minute. The relay actuates a solenoid that feeds high pressure air or water to the Hydrogen Peroxide flow cell. The turbulence blasts away any biofilms or soft precipitating coatings from the sensors, flow cells and lines. The greatest turbulence is in the Hydrogen Peroxide flow cell but both flow cells are agitated as are the feed lines. The duration and period of the cleaning cycle can be easily adjusted to suit the needs of the installation. (See section [3.3.3 Configuring Alarm Relays](#))

1. Remove the ¼" polypropylene tube from the John Guest fitting on the right side of the solenoid cleaner enclosure.
2. Provide 20-40 psi water or air to the ¼" fitting.