



# Instruction Manual

## Model CA900 Sulfide Analyzer



## PREFACE

Purchasing products from Electro-Chemical Devices, Inc. provides you with the finest liquid analytical instrumentation available. If this is your first purchase from ECD, please read the entire manual before installing and commissioning your new equipment.

Manuals are accessible on the ECD website at <https://ecdi.com/product-literature/product-literature/>.

If there are any questions concerning this equipment, please contact your local ECD representative, or the factory directly at:

**Electro-Chemical Devices, Inc.**

1500 North Kellogg Dr.

Anaheim, CA 92807 USA





Telephone: +1-714-695-0051

FAX: +1-714-695-0057

Website: [www.ecdi.com](http://www.ecdi.com)

Email: [sales@ecdi.com](mailto:sales@ecdi.com)

## SYMBOLS USED IN MANUAL

	This symbol is used to designate important information, warnings and cautions. Failure to follow this information could lead to harm to the instrument or user.
	No operator serviceable parts, service by authorized service personnel only.
	This symbol is used to designate a WARNING "Risk of Electrical Shock"
	Disconnect supply before servicing
	Equipment protected throughout by double insulation.

Contents of this manual are believed to be correct at the time of printing and are subject to change without notice. ECD is not responsible for damage to the instrument, poor performance of the instrument or losses resulting from such, if the problems are caused by:

- Incorrect operation by the user.
- Use of the instrument in incorrect applications.
- Use of the instrument in an inappropriate environment or incorrect utility program (power supply).
- Repair or modification of the related instrument by anyone not authorized by ECD.
- There are no operator accessible parts. Service and maintenance to be done by authorized personnel only.
- If the equipment is used in a manner not specified by the manufacturer, the protection provided by the equipment may be impaired.

	Read the complete manual before installing or using the equipment.
---	--

© 2021 Electro-Chemical Devices, Inc. All rights reserved. No part of this manual may be used or reproduced in any form or by any means, or stored in a database or retrieval system without prior written permission from Electro-Chemical Devices, Inc. Making copies of any part of this manual for any purpose other than personal use is a violation of United States copyright laws. Document printed in the United States of America.

## RETURN GOODS POLICY

All requests for returned goods must be initiated through our Customer Service Department. Please call our phone number (714) 695-0051 with the specifics of your request. The following conditions must be satisfied for consideration of applicable credit for the return of products purchased from Electro-Chemical Devices:

- 1) The item is unused and in the original package.
- 2) The item was shipped directly from Electro-Chemical Devices.
- 3) The item has not been damaged in shipment to Electro-Chemical Devices.
- 4) Items containing date-sensitive parts such as electrodes, must be returned within 1 month of the invoiced date.
- 5) Items without date-sensitive parts must be returned within 3 months of the invoiced date.

A Return Merchandize Authorization Number must be obtained from Customer Service and be provided on all paperwork and packaging. To obtain a Return Merchandize Authorization Number, please provide the reason for return, the date of purchase, your original purchase order number, and either our order number or our invoice number. The issuance of a Return Merchandize Authorization Number is a verbal approval for return only and does not guarantee credit or allowance. Returned goods must be received within 30 days of the issuance date of the Return Merchandize Authorization Number or it will become null and void.

Necessary physical and mechanical inspection is completed upon receipt of the item. Applicable credit or equivalent allowance is determined after inspection of the returned item. If all of the above conditions are met, and the item has been approved to return to our stock, a restocking charge of 25% of the purchase price is deducted from the applicable credit

## IMPORTANT SERVICE INFORMATION

Use only factory authorized components for repair. Tampering or unauthorized substitution of components may adversely affect the operation of this product and may void the warranty.

If service or repair is required, please obtain the serial number(s) or sales order number of the product(s) in question and contact ECD's Service Department at:

+1-800-729-1333 (USA/Canada) or +1-714-695-0051  
or email [Service@ecdi.com](mailto:Service@ecdi.com)

**A Return Material Authorization (RMA) number must be obtained** from the service department before returning any material to ECD. All material returned to ECD shall be shipped prepaid to the factory.

## RECEIVING THE INSTRUMENT

Your Electro-Chemical Devices instrument has been carefully packaged to protect it from damage during shipment and dry storage. Upon receipt please follow the procedure outlined below.

1. Before unpacking, inspect the condition of the shipping container to verify proper handling by the carrier. If damage is noted, save the shipping container as proof of mishandling for the carrier.
2. Check the contents of the shipping container with the items and quantities shown on the packing list. Immediately report any discrepancies to ECD.
3. Save the original packing material until you are satisfied with the contents. In the event the product(s) must be returned to ECD, the packing material will allow you to properly ship it to ECD.
4. Familiarize yourself with the instrument before installation, and follow proper installation and wiring procedures.



WARNING Electrical installation must be in accordance with the National Electrical Code (ANSI/NFPA-70), Canadian Electrical Code and/or any other applicable national or local codes.

# INSTALLATION PREP

Failure to follow the proper instructions may cause damage to this instrument and warranty invalidation. Use only qualified personnel to install, operate and maintain the product.

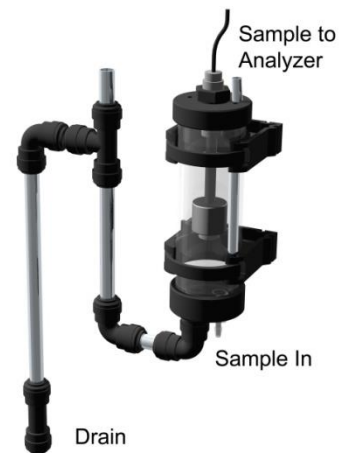
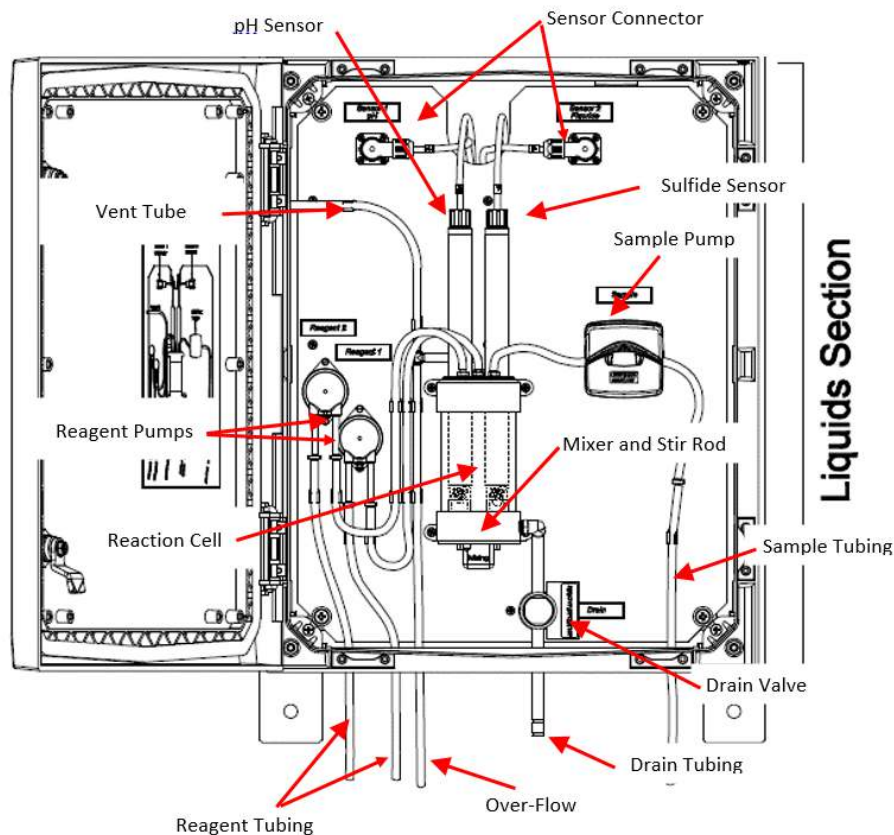

Fast Loop Reservoir

## SAMPLE REQUIREMENTS

Minimum flow: 0.4 gal/hour, (1.5 L/hr)

Temperature: 32° to 122°F (0° to 50°C)

Sample Pressure: Drawn from atmospheric pressure

The Sample Conditioning Cell provides an atmospheric sample point that can adapt to changing sample flows between 0.4 and 10 gal/hr (1.5 -37 L/hr).

## CONNECTING THE INLET AND DRAIN FITTINGS

### Sample Inlet:



The sample must be drawn from atmospheric pressure. The sample feed tube is 8 mm OD x 4.8 mm bore (5/16" OD x 3/16" bore). The sample tube can be placed directly in an open reservoir of the sample water or connected to the reservoir with a 3/16" barb fitting.

**A Sample Conditioning Cell Loop Flow Reservoir:** is available for pressurized samples. This Fast Flow Reservoir allows the sample to fill a 200 ml sampling cell and overflow the balance of the feed to an atmospheric drain. The input to the sample cell is a 1/4" barb fitting is supplied for sample connection but a compression style tube fitting can also be used (not supplied). The sampling port is a stainless steel tube that accommodates the sample feed tubing to the analyzer. The overflow drains through the 12 mm overflow tubing exiting the bottom of the Sample Conditioning Cell. Attach a length of 12 mm soft tubing and allow the overflow to drain to open atmosphere. Do not restrict the drain line. The pressurized feed must have an adjustable shut off valve. Adjust the feed so that the Sample Conditioning Cell fills and starts overflowing in 2 minutes or less. Filling the cell in 2 minutes provides the minimum sample flow (1.5 liters/hour), faster feed rates simply overflow to the drain.

### Sample Drain:

The neutralized sample and the water from the rinse cycles drain from the measurement cell when the solenoid valve is actuated. The drain line must drain to atmospheric pressure.

### CONNECTING THE REAGENTS

	<b>DANGER: Read any precautions and the (SDS) datasheets, wear protective gloves, clothes and glasses before handling chemical products.</b>
	<b>Hazard of severe burns or injury due to handling of dangerous chemicals</b>

Connect the tubing from the reagent pumps to the insertion tubes. Press the insertion tube from Reagent Pump 1 through the grommet in the cap of the 16% KOH solution. Press the insertion tube from Reagent Pump 2 through the grommet in the cap of the 7.5% HCl solution.

### INSTALLING THE SENSORS

The CA900 Sulfide Analyzer is supplied with the sensor cables pre-wired to the analyzer. Simply install the sensors in the flow cell as described below.

The Sulfide and pH sensors mount in the Flow Cell in a O-ring press fitted seal. Remove the protective cap(s) from the sensors and save them for future use. The sulfide ion will also have an extra red/orange colored cap around its sensing element. The cap contains a potassium chloride solution, use care when removing the cap from the sensor to avoid spillage. Loosen the fitting on the flow cell to allow the sensor to be inserted into the fitting. Insert the sensor into the fitting until a good seal is made. There is a swage type seal and an o-ring seal inside the fitting, the twisting motion will facilitate passing these seals. Gently slide the sensor down into the fitting until you deal is captured. Repeat the same installation process for the other sensor.



The CA900 Sulfide Analyzer instrument and sensors were calibrated at the factory and should be ready for use when assembled. However, changes may have occurred during shipping and storage that require recalibration. (See Calibration section below)

# TERMS AND CONDITIONS OF SALE

1. **ACCEPTANCE.** If this writing differs in any way from the terms and conditions of Buyer's order or if this writing is construed as an acceptance or as a confirmation acting as an acceptance, then Seller's acceptance is **EXPRESSLY MADE CONDITIONAL ON BUYER'S ASSENT TO ANY TERMS AND CONDITIONS CONTAINED HEREIN THAT ARE DIFFERENT FROM OR ADDITIONAL TO THOSE CONTAINED IN BUYER'S WRITING.** Further, this writing shall be deemed notice of objection to such terms and conditions of Buyer. If this writing is construed as the offer, acceptance hereof is **EXPRESSLY LIMITED TO THE TERMS AND CONDITIONS CONTAINED HEREIN.** In any event, Buyer's acceptance of the goods shall manifest Buyer's assent to Seller's terms and conditions. No addition to or modification of these terms will be effective, unless set forth in writing and agreed to by Seller.
2. **WARRANTIES AND REMEDIES**
  - a. **Warranty.** Seller warrants to Buyer that it holds and will pass marketable title to the goods sold hereunder. Seller warrants to Buyer that the items and components manufactured by Seller will be free from defects in material and workmanship (subject, however, to tolerances and variances permitted by the trade hereunder) for a period one (1) year for non-consumable products. Consumable electrodes and sensors have a conditional warranty based shelf life and process conditions and is determined by Seller.
  - b. **Exclusion and Conditions.** Seller's obligations with respect to the express warranties and remedies contained herein are conditioned on the following: (i) Buyer's return of the non-conforming goods, if authorized by Seller; (ii) Buyer shall not assign its rights under these express warranties and any attempted assignment shall render such warranties, but not any disclaimers or limitations, void and the goods sold shall be sold **AS IS**; and (iii) all products shall be carefully inspected for damage by Buyer upon receipt, be properly calibrated for Buyer's particular use, and be used, repaired, and maintained by Buyer in accordance with the instructions set forth in Seller's product literature. Repair and maintenance by non-qualified personnel, product subjected to misuse or negligence, and/or damaged during shipment will invalidate the warranty, as will the use of non-approved consumables or spare parts. As with any other sophisticated product, it is essential, and a condition of Seller's warranty, that all personnel using the product be fully acquainted with its use, capabilities and limitations as set forth in the applicable product literature.
3. **DISCLAIMER OF IMPLIED WARRANTIES.** Seller gives no warranties except those expressly contained herein. Seller **disclaims** all other warranties implied by law usage of the trade, course of dealing or course of performance including, but not limited to, **the implied warranties of MERCHANTABILITY and fitness for a particular purpose.**
4. **LIMITATIONS OF LIABILITY.** The following limitations of Seller's liability are acknowledged by the parties to be fair and reasonable and shall apply to any act or omission hereunder, and to any breach of this contract of which these terms and conditions form a part:
  - a. **Disclaimer of Damage.** In no event shall Seller be liable for special, indirect, consequential or incidental damages whether arising under contract, warranty, tort, strict liability or any other theory of liability. Such damages include but are not limited to loss of profits, loss of use of goods, damage to property, and claims of third parties.
  - b. **Suitability.** Buyer acknowledges that it alone has determined the intended purpose and suitability of the goods sold hereunder. It is expressly agreed by the parties that any technical or other advice given by the Seller with respect to the use of the goods or services is given without charge and at Buyer's risk; therefore Seller assumes no obligation or liability for the advice given or results obtained.
  - c. **Notice and Time of Claims.**
    - i. Buyer agrees to check and inspect all products against shipping papers and for damage or shortage upon receipt of goods at destination.
    - ii. Every claim for shortage, damage in transit, or other cause visible upon inspection shall be deemed waived by the Buyer, or the Buyer's customer in the case of resale, unless delivered in writing to Seller by Buyer thirty (30) days from the tender of delivery of the goods to Buyer, provided, however, that claims for shortage must be made within seven (7) days of receipt.
    - iii. The parties expressly waive the statute of limitations and agree that any legal proceeding for any breach of this contract shall be waived unless filed within one (1) year after the accrual of the cause of action thereof.
5. **FORCE MAJEURE.** Seller shall not be liable for any delay in delivery, or failure to deliver, due to any cause beyond the Seller's control including but not limited to fires, floods, or other forces of the elements; strikes, or other labor disputes; accidents to machinery; acts of sabotage; riots; precedence or priorities granted at the request or for the benefit, directly or indirectly of the federal or any state government or any subdivision or agency thereof; delay in transportation or lack of transportation facilities; restrictions imposed by federal, state or other governmental legislation or rules or regulations thereof. If Seller, in its sole discretion, determines that Seller's performance hereunder would result in a loss to Seller's on this sale as computed under Seller's normal accounting procedures because of causes beyond Seller's control, then the Seller may terminate this agreement in whole or in part without liability for any delay in the delivery of, or failure to deliver, the goods sold hereunder
6. **TAXES AND OTHER CHARGES.** The Buyer will pay, or reimburse Seller if it pays, any and all taxes or tariffs or any other similar charges imposed upon this contract, the goods covered hereby or the delivery or use or resale thereof.
7. **FREIGHT CHARGES.** If the sale hereunder is other than F.O.B. Seller's facility, this acknowledgement is based upon the freight charges now in effect. In the event of an increase or decrease in applicable freight charges before the goods are shipped, such charge in freight will be for the Buyer's account.
8. **PRICES AND DELIVERY.** Prices quoted herein are F.O.B. shipping point. Deliveries specified are only our best estimate and are subject to change. This quotation is based upon freight charges now in effect. Buyer will be invoiced at the freight charge prevailing at the date of shipment. Prices are firm for orders meeting Seller's normal shipping schedules. If shipments are held or postponed for any reason other than Seller's fault, and a price increase becomes effective during the period of such hold or postponement, the increase will apply to all shipments that are held or postponed thirty (30) days or more from the effective date of the increase.
9. **PAYMENTS.** If in the judgment of Seller the financial condition of Buyer at any time prior to shipment does not justify the terms of payment specified, Seller may cancel the order, withhold shipment, and/or require full or partial payment in advance. If payment is not made when due, Seller may suspend all future delivery or other performance with respect to Buyer without liability or penalty and, in addition to all other sums payable hereunder, Buyer shall pay to Seller (i) the reasonable costs and expenses incurred by Seller in connection with all actions taken to enforce collection or to preserve and protect Seller's rights hereunder, whether by legal proceedings or otherwise, including without limitation reasonable attorneys' fees, court costs and other expenses and (ii) interest on all amounts unpaid after 30 days charged at the monthly rate of 1-1/2% or the highest rate permitted by law, whichever is lower.
10. **CANCELLATION OR ALTERATION.** Buyer may not alter or cancel any order without Seller's written consent. For any order altered or cancelled with Seller's consent, Buyer must pay for all expenses and labor incurred up to the time of Seller's consent, plus a reasonable percentage for profit. Any order delayed or deferred by Buyer will be subject to price escalation for increased costs of production, and any other expenses caused by the delay. Material on such orders will be stored at Buyer's risk. Seller reserves the right to invoice Buyer and require payment before shipment of any delayed or deferred order.
11. **TITLE AND RISK OF LOSS.** Title and risk of loss shall pass to buyer at Anaheim, California, unless otherwise specified in the contract. If delivery is made by common carrier, risk of loss shall pass upon delivery to the carrier. Claims for loss or damage in transit must be made by Buyer to the carrier. Seller accepts no responsibility for loss or damage to product in transit.
12. **PATENT OR TRADEMARK INFRINGEMENT.** If the goods sold hereunder are to be prepared for manufacture according to Buyers specification, Buyer shall indemnify Seller against any claim or liability for patent, trademark, service mark or trade name infringement on account of preparation, manufacture and/or sale.
13. **NON-WAIVER.** If Government Contract Regulations require the addition, deletion, or modification of these terms and conditions upon prior notification to Seller and Seller's written acceptance thereof, such changes shall become a part of these terms and conditions. Seller shall not be bound by any Government Contract Regulations applicable to Buyer's contracts with the U.S. Government unless Buyer has expressly acknowledged, on the face of this document, the applicability of such Regulations to the transaction between Buyer and Seller contemplated herein. Absent such acknowledgement, Seller is making the assumption in issuing this document that no such Regulations apply.
14. **JURISDICTION.** All such disputes shall be resolved in a court of competent jurisdiction in Orange County, California. Buyer hereby consents to the jurisdiction of the State and Federal Courts sitting in Orange County. Notwithstanding the above, should either party contest the jurisdiction of such courts, the other party may institute its suit in any court of competent jurisdiction.
15. **APPLICABLE LAW.** All questions arising hereunder or in connection with the quotations or any order submitted in connection therewith and/or the performance of the parties hereunder shall be interpreted and resolved in accordance with the laws of the state of California without regard to its conflict of law provisions and excluding the United Nations Convention on the International Sale of Goods.



# Table of Contents

Preface .....	2
Symbols Used in Manual .....	3
Return Goods Policy .....	4
Important Service Information .....	5
Receiving the Instrument .....	5
INSTALLATION PREP .....	6
Sample Requirements .....	6
Connecting the Inlet and Drain fittings .....	6
Connecting the Reagents .....	7
Terms and Conditions of Sale .....	8
1.0 Overview .....	13
1.1 Features .....	13
1.2 Specifications .....	13
2.0 Safety Precautions, Instructions and Hazards .....	14
2.1.1 General Information .....	14
2.1.2 List of Warnings and Potential Dangers .....	15
2.1.3 Reagents .....	16
2.1.4 Sample Stream .....	16
2.1.5 Waste Disposal of the liquid reagents for the reaction .....	16
2.1.6 Analyzer General Hazards .....	17
2.1.6.1 Electrical precautions and hazards .....	17
2.1.6.2 Operating precautions and hazards .....	17
2.1.6.3 Chemical and waste gas hazards .....	17
3.0 Introduction – Analyzer Description .....	18
3.1 Applications .....	18
3.2 Working principle: Ion Selective (ISE) using ECD Sulfide Electrode .....	18
3.3 Analysis Cycle .....	18
3.3.1 Typical Run Sequence .....	19
3.3.2 DISSOCIATION FACTOR .....	19
3.3.3 DISSOCIATION FACTOR TABLE pH correction .....	19
3.3.4 Priming the analyzer before start .....	20
4.0 Components .....	21
4.1 Electrical Section .....	23
4.2 Liquids Section .....	25
4.2.1 Pumps .....	26
4.2.2 Drain Valve .....	26
4.2.3 Reaction Cell .....	26
4.2.4 SULFIDE SENSOR .....	26

4.2.5	pH Sensor .....	26
5.0	Mounting.....	27
5.1	Wiring .....	28
5.1.1	Wiring, Power .....	28
5.1.2	Wiring, Analog Outputs (Ao) .....	28
5.1.3	Wiring, Contact Relay Outputs .....	28
5.1.4	Wiring, Digital Input (Di).....	28
6.0	Reagents and Buffers.....	29
7.0	OPERATION .....	30
7.1	Conventions .....	30
7.1.1	Definitions .....	30
7.1.2	Colors .....	31
7.1.3	Buttons and Indicators .....	31
7.1.3.1	Special Buttons .....	31
7.1.4	Popup Screens .....	32
7.1.5	Pulldown Screens.....	32
7.2	Startup Screen.....	32
7.3	Menu Map .....	33
7.4	Base Screens .....	34
7.4.1	Base Screen A (Main) .....	35
7.4.1.1	Base Screen A (Main Run) .....	36
7.4.1.2	Main Screen A (Run Continuous).....	37
7.4.1.3	Main Screen A1 (Run Recipe) .....	38
7.4.2	Base Screen B .....	39
7.4.2.1	Base Screen B (Manual Activation: Sample Pump) .....	40
7.4.2.2	Base Screen B (Manual Activation: Reagent Pump) .....	41
7.4.2.3	Base Screen B (Manual Activation: Drain) .....	42
7.4.2.4	Base Screen B (Manual Activation: Bottle Maintenance) Reset after every Bottle change .....	43
7.4.2.5	Base Screen B (Manual Activation: Mixer).....	44
7.4.3	Base Screen C (Sensor Data).....	44
7.4.4	Base Screen E (Sulfide Chart).....	45
7.5	Maintenance Menu and Functions .....	46
7.5.1	Maintenance Menu: RINSE .....	46
7.5.2	Maintenance Menu: DRAIN.....	47
7.5.3	Maintenance Menu: STORE SENSOR .....	48
7.6	Menu Functions (Menu Home Screen) .....	49
7.6.1	Alarm Log .....	50

7.6.2	Configure.....	51
7.6.2.1	Configure (System Menu) .....	52
7.6.2.1.1	Language.....	52
7.6.2.1.2	Bottle Maintenance .....	52
7.6.2.1.3	Display .....	53
7.6.2.1.4	Datalog .....	54
7.6.2.1.5	Ethernet Settings .....	54
7.6.2.1.6	Password .....	55
7.6.2.1.7	System Settings.....	56
7.6.2.1.8	I/O – Digital Inputs .....	57
7.6.2.1.9	I/O – 4-20 mA and Relays .....	58
	(See Section 7.6 for 4-20 mA and Section 7.7 for Relays) .....	58
7.6.2.1.10	Reset User Choices.....	58
7.6.2.2	Configure (Sensor Menu).....	59
7.6.3	Cal Sensor 1 .....	59
7.6.4	Information.....	60
7.6.4.1	Sensor Info .....	60
7.6.4.2	System Info.....	61
7.7	Analog Outputs (4-20 mA) Configurations .....	62
7.7.1	4-20 mA (Process Variable, PV) .....	63
7.7.2	4-20 mA (Sensor Value).....	64
7.7.3	4-20 mA (Sensor Temperature) .....	64
7.7.4	4-20 mA (Digital Input, Di 1-4).....	65
7.8	Relay Configurations.....	66
7.8.1	Relay Type (Alarm).....	67
7.8.1.1	Relay Type (Alarm – Sensor 1 Value).....	68
7.8.1.2	Relay Type (Alarm – Sensor 1 Temperature) .....	68
7.8.1.3	Relay Type (Alarm – Process Variable) .....	68
7.8.1.4	Relay Type (Alarm – Digital Input).....	69
7.8.2	Relay Type (Timed) .....	69
7.8.3	Relay Type (Fault) .....	70
7.8.4	Relay Type (Disable).....	70
7.8.5	Relay Type (Simulation).....	70
7.9	Calibration.....	71
7.9.1	Auto Calibration.....	72

7.9.2	Standardize Calibration.....	73
7.9.3	Manual Calibration .....	73
7.9.4	Temperature Calibration.....	73
7.10	Menu and User Interface Configurations.....	74
7.10.1	System Hold Indications.....	74
8.0	Maintenance .....	75
8.1	VISUAL CHECK .....	75
8.2	MONTHLY.....	75
8.3	EVERY 4-6 MONTHS (DEPENDING ON APPLICATION) .....	75
8.4	ANNUAL.....	75
9.0	Troubleshooting .....	76
10.0	Sensor Maintenance.....	77
10.1	Electrode Cartridge Replacement.....	77
10.2	Electrode Cartridge Maintenance .....	77
10.2.1	CLEANING.....	77
10.3	S80/DS80 Sensor Specifications.....	78
10.3.1	Sulfide Electrode.....	78
11.0	Analyzer Shutdown.....	79
Appendix A	Purchasing Information.....	80
Appendix B	Parts and Accessories .....	81

# 1.0 OVERVIEW

Thank you for purchasing our Model CA900 Sulfide Analyzer.

The CA900 Sulfide Analyzer was designed and manufactured to be an easy-to-use, high-sensitivity and low-cost measuring instrument. This Analyzer should give you many years of reliable and hassle-free operation with regular care and maintenance.

This document is the Operating Manual for the Analyzer. We recommend you record the purchasing information on the form in Appendix A Page 80.

The Model CA900 Sulfide Analyzer is 100-240 VAC line powered, 50/60 Hz. Available options include, (4) 4 to 20 mA outputs, (4) configurable Relays (for Alarm, Timed Relay, and Fault), (4) digital inputs, and Ethernet communication.

## 1.1 FEATURES

1. User-replaceable sensor cartridge at minimal cost.
2. Simple, user friendly menu structure.
3. Noise free digital communication with sensors.
4. Reads and writes calibration data to sensor.
5. Non-Isolated 4-20 mA output.
6. Ethernet control and monitoring functions.
7. Datalogging of the Sulfide primary variable the Sulfide sensors, (4) 4-20 outputs, (4) digital inputs, and events.
8. Remote measurement cycle activation.

## 1.2 SPECIFICATIONS

Analysis	Sulfide
Measuring Range	0 to 1000ppm.
Response Time	6 minute cycle plus any user entered wait time.
Repeatability	+/- 2%
Drift	+/- 2% per month of full scale measurements
Input Signals	Non-Isolated 4-20 mA Input Non-Isolated Digital Input Non-Isolated Remote activation (using Digital Input 1)
Output Signals	4-20mA; Ethernet
Contact Relays	Four (4) SPDT, 1 form C (NO - Normally Open, C - Common, NC - Normally Closed), 250 VAC, 15 Amp resistive maximum relays, user configurable as Hi/Lo alarms with expiration timer, Periodic or Fault alarms
Display	Color 12cm W x 9cm H (4.6in. W x 3.5in. H) LCD with resistive touch panel.
Enclosure	Wall mounted, Beige Polycarbonate, IP65, weatherproof, 17 in W x 32 in H x 9 in D / 43cm W x 81cm H x 23cm D
Power	100-240 VAC, 50/60 Hz, 0.7 to 1.4A, protected with 250V, 14A Breaker
Operating Temperature	-5°C - 50°C (23 - 122°F)
Relative Humidity	0 – 80%, up to 31°C Decreasing linearly to 50% RH at 40°C
Altitude	Up to 2000m (6500ft.)
Mains Supply Voltage	Fluctuations up to ±10% of the nominal voltage Transient over voltages: CAT II Pollution Degree: 2
Shipping	Size1 43cm x 30cm x 23cm (7 in W x 11.7 in H x 9 in D) Weight 17kg (38 lbs.)

## 2.0 SAFETY PRECAUTIONS, INSTRUCTIONS AND HAZARDS

	<p>This Manual contains important information required to install, start up and operate the Model CA900 PH Comp with Sulfide ONLY Analyzer. Please read the entire manual carefully before installing or placing the analyzer into service!</p>
---	---

### 2.1.1 GENERAL INFORMATION

Pay attention to all Caution and Danger labels present on the analyzer and all Caution and Danger statements written in this manual.

Electro-Chemical Devices shall not be liable for errors contained herein and/or for the incorrect use of the analyzer. The analyzer's users must read the User's Manual before placing the CA900 Sulfide Analyzer into service. Observe the instructions and follow all national and local regulations and laws regarding workers health and safety.

The use, maintenance and service of this analyzer is restricted to qualified personnel, fully trained in the analyzer's operations. These personnel are intended to be physically and mentally fit and not under the influence of drugs or alcohol.

When the analyzer is not in use, it should be protected from intentional or unintentional powering up, using a proper power switch.





Failure to do so or non-observance of hazards or dangers warnings could result in death or serious injury to the operators or damage to the analyzer.

Before using the analyzer, it is necessary to visually check for damage to the safety devices and to report them to your supervisor even if they don't cause analyzer stop or malfunction.

All of the analyzer's components are installed inside a plastic enclosure; a special key is required to open the door, only qualified maintenance personnel should have access to the key.

### 2.1.2 LIST OF WARNINGS AND POTENTIAL DANGERS

The table below is a list of Hazard and Danger Warning Labels found on the analyzer and/or in this manual. Damaged or illegible labels should be replaced with new ones by the analyzer owner.

	<p>Poisonous Substances:</p> <p>Very hazardous to health when inhaled, swallowed or when they come in contact with the skin. May even lead to death. Danger! Avoid contact with the human body and immediately contact a physician in case of contact.</p>	<p>Involved parts:</p> <ul style="list-style-type: none"> <li>• fluids section</li> <li>• reagent containers</li> </ul>
	<p>Hazard of electrical shock</p> <p>This symbol is used to represent a hazard of severe electric shock or electrocution. All adjustments and maintenance on electrical devices labeled with this symbol should be made by qualified personnel in accordance with national or local regulations. Qualified Personnel means a person who has been fully trained and has professional experience to avoid electrical hazards and dangers. To avoid potentially fatal electrical shock and/or analyzer damage always disconnect input power to analyzer before servicing.</p>	<p>Involved parts:</p> <ul style="list-style-type: none"> <li>• main power supply</li> <li>• peristaltic pump motor</li> <li>• input terminal</li> </ul>
	<p>Hazard of chemical burns</p> <p>This symbol is used to represent a hazard of severe burns or injury due to handling of dangerous chemicals. All handling, maintenance and filling operations of chemicals labeled with this symbol should be made by qualified personnel in accordance with national or local regulations. Qualified Personnel means a person who has been fully trained and has the professional experience to avoid chemical hazards and dangers. Before handling the chemicals or proceeding with service operations, read the material safety data sheets supplied with each chemical and follow all necessary precautions when handling.</p>	<p>Involved parts:</p> <ul style="list-style-type: none"> <li>• Fluids section</li> <li>• Reagent containers</li> </ul>
	<p>Harmful</p> <p>Specific warning depending on the parameter analyzed and the amount of reagents.</p>	<p>Involved parts:</p> <ul style="list-style-type: none"> <li>• Fluids section</li> <li>• Reagent containers</li> </ul>
	<p>Warning of general hazard</p> <p>This symbol means that is necessary read the manual before proceeding to any service operation in order to properly perform the operation. Only qualified personnel, fully trained on the analyzers use and maintenance are allowed to proceed with service operations on the unit.</p>	

### 2.1.3 REAGENTS

The Model CA900 Sulfide Analyzer is based on Ion-Selective (ISE) analysis methods, caustic and acidic reagents to raise and lower the pH of the sample, allowing for the release of the sulfide ions. For the dangers and hazards regarding the chemicals used for the analysis, refer to Chapter 6.0 Page 29 for reagent use.

Make sure that proper safety precautions are taken (e.g. using safety gloves and glasses) during handling the chemical solutions and the reagents containers / bottles.

Read carefully the Material Safety Data Sheets of each chemical. All bottles of reagents must be labeled with the specific hazards and dangers labels.



#### **THE REAGENT INPUT MUST BE AT ATMOSPHERIC PRESSURE**

Failure to do so will cause tubing rupture and over-filling of the Reaction Cell which will cause incorrect readings. In addition, the Reagent could be damaged.

### 2.1.4 SAMPLE STREAM

Take appropriate precautions to avoid direct contact with sample stream. It is the responsibility of the user to collect all the information and take all the precautions regarding physical, chemical, radiation and/or biological hazards and dangers coming from sample stream and/or sample vapors. It is also responsibility of the user to collect all the information and potential hazards regarding the chemical and physical compatibility of sample stream with the analyzer materials.

Table 1: List of materials used in the Model CA900 Sulfide Analyzer

Pump tubing	Silicon
Fittings	PP
Connection tubing	Silicon
Reaction cell	PVC
Drain valve	Norprene®



#### **THE SAMPLE STREAM MUST BE AT ATMOSPHERIC PRESSURE**

Failure to do so will cause tubing rupture and over-filling of the Reaction Cell which will cause incorrect readings. In addition, the Sample Pump could be damaged.

### 2.1.5 WASTE DISPOSAL OF THE LIQUID REAGENTS FOR THE REACTION

The liquid from the drain of the reaction cell may need to be collected in a separate canister. For guidelines on disposal consult the requirements of the Local Authority for chemical waste regulation. Arrange removal by a Disposal Company.



## 2.1.6 ANALYZER GENERAL HAZARDS

### 2.1.6.1 Electrical precautions and hazards

1. Power to the CA900 Sulfide Analyzer must be routed through an ON/OFF power switch.
2. Mind the electrical shock and/or electrocution labels placed on the analyzer.
3. All electrical devices powered by 110/220 VAC present the hazard of electrical shock or electrocution.
4. The analyzer enclosure is equipped with a door that requires a special key for opening to protect all the personnel involved in analyzer use and maintenance.
5. Only Qualified Service Personnel should have access to the key that opens the analyzer.
6. Before servicing the analyzer or any parts that are electrically powered, turn off the power to avoid the risk of electrocution.
7. Inside the analyzer's lower level, the electrical protection is IP2X. Analyzer's enclosure is IP54.
8. Protection against electrical shock is guaranteed by the grounding of all isolated metal surfaces. Grounding terminal/screw is located inside the electrical enclosure, in Upper Left position.
9. It is the user's responsibility to periodically check the efficacy of analyzer's electrical ground.
10. In case of loss of power, the analyzer stops and automatically restarts as soon as power is returned.

### 2.1.6.2 Operating precautions and hazards

1. **HAZARD:** Mechanical hazards caused by moving parts such as the peristaltic pump, the motor...

#### PREVENTIVE ACTIONS:

To avoid risks the analyzer's moving parts have been designed, built and located in an enclosure with a special key. When present inside the enclosure, these parts have protection covers to avoid any contact and physical injuries to users.

2. **HAZARD:** Hazard of burns and poisoning caused by contact with dangerous chemicals

#### PREVENTIVE ACTIONS:

To avoid risks, the analyzer's parts that can cause contact with chemicals have been designed, built and located in closed enclosure with a special opening key. Before servicing the liquids section, read the material safety data sheets supplied with each chemical to take all the necessary precautions when handling. Wear eye protections, gloves, mask and protective clothing if necessary.

3. **HAZARD:** Hazard of poisoning caused by waste gas leaking from the hydraulic parts or waste collector.

#### PREVENTIVE ACTIONS:

Install the analyzer in location of adequate dimensions and in a well-ventilated area.

4. **HAZARD:** Hazard of electric shock and/or electrocution inside the electrical enclosure.

#### PREVENTIVE ACTIONS:

The analyzer's electric equipment complies with EN 60204 requirements.

To avoid risks, the analyzer's parts that can cause hazard of electric shock and/or electrocution have been designed, built and located in an enclosure with a special key. When working inside the enclosure, these parts have protective covers and warning labels to avoid any contact and serious injuries or death to users.



**Note:** Electrical equipment, input power and grounding must comply with all national and local regulations and laws.

Check that the source voltage to be used corresponds with that requested by the analyzer.

Check periodically the power cord as well as the analyzer grounding.

Check periodically the power cord as well as the analyzer grounding.

### 2.1.6.3 Chemical and waste gas hazards

The analyzer has been designed, built and equipped to avoid risks caused by physical and chemical factors such as noise, vibrations, radiations, dust, waste gas etc.

## 3.0 INTRODUCTION – ANALYZER DESCRIPTION

This manual provides general information regarding the principles of operation, the proper installation and operation of the CA900 Sulfide Analyzer.

The Model CA900 is an on-line sequential sampling analyzer (a sequence of sampling, analysis and result processing), using Ion-Selective (ISE) methods.

The analyzer is assembled with two separated sections with two lockable doors. The top section is the ELECTRICAL enclosure. It includes the main power supply, the controller PCB assembly and the touch screen interface. The bottom section is the LIQUIDS section. It includes all of the components involved in the flow, mixing and reaction stages of the sample and reagents (sampling pump, Ion-Selective (ISE) Sensor, reaction cell...).



### 3.1 APPLICATIONS

The CA900 Sulfide Analyzer is an all in one analyzer for the continuous measurement of sulfide ions in aqueous solution. Sulfide ions are present in well water, municipal waste water and waste waters from refineries, tanneries, chemical plants and paper and pulp facilities.

Hydrogen sulfide ( $H_2S$ ) is a gas that dissolves in water and gives it that “rotten egg” odor.  $H_2S$  exists as a dissolved gas in acidic water, as bisulfide ions ( $HS^-$ ) in water with pH values above pH 7 and as sulfide ions ( $S^{2-}$ ) in water with very high pH values, values above pH 12.9

### 3.2 WORKING PRINCIPLE: ION SELECTIVE (ISE) USING ECD SULFIDE ELECTRODE

The CA900 Sulfide Analyzer uses a sulfide ion selective electrode (ISE) to measure the total amount of sulfide present in the sample. The measurement must be made at high pH levels where  $S^{2-}$  exists. Potassium hydroxide (KOH) is added to raise the pH of the sample to around pH 12.9 and a pH electrode measures the actual pH. Sulfide and bisulfide exist in a pH dependent equilibrium with the ratio dependent on the pH. The sulfide ISE measures the sulfide present in the sample and the pH measurement infers what percentage of the total sulfide was measured. The CA900 Sulfide Analyzer calculates and displays the Total sulfide present in the sample.

The highly caustic sample is then neutralized with HCl and the pH is measured and displayed to verify the neutralization. The KOH is neutralized with HCl producing potassium chloride salt (KCl) and water. The neutralized sample can be disposed of as waste or returned to the water supply. Each cycle uses about 1 ml of caustic and 1 ml of acid.

### 3.3 ANALYSIS CYCLE

The analyzer is set to run 6 minute analysis cycles (10 cycles per hour) but can easily be programmed to run 12 minute cycles (5 cycles per hour) or 30 minute cycles (2 cycles per hour). Running continuously at 10 cycles per hour, the CA900 Sulfide Analyzer uses 10 liters (2.5 gallons) of each reagent per month and at 2 cycles per hour less than 2 liters (0.5 gallon) per month.

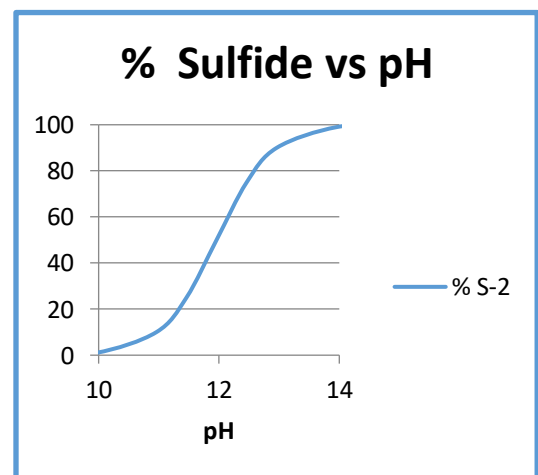

Figure 3.1

### 3.3.1 TYPICAL RUN SEQUENCE

Rinse	The rinse cycle draws in liquid from the sample input to flush the Reaction Cell of any previous run residue.
Sample input line	A quantity of liquid is drawn from the sample line to test.
Mixer On	The mixer is turned on as a preface to add reagent.
Add Reagent 1	A quantity of reagent is added as part of the measurement to raise the pH above 12.9.
Wait	The analyzer waits to give time for the sensor to react to the mixture.
Measure Sulfide	The Sulfide value is read from the ISE sensor.
Add Reagent 2	A quantity of reagent is added as part of the measurement to lower the pH to a neutralize state for be disposed
Drain	The test mixture is drained from the Reaction Cell
Rinse	The rinse cycle draws in liquid from the sample input to flush the Reaction Cell of any previous run residue.
END	Signal to end or stop the current run cycle.

Sulfide Ion Electrode only measures the sulfide ion (S<sup>2-</sup>) component of the total sulfide present in the sample. It does not “see” bisulfide (HS<sup>-</sup>) or hydrogen sulfide (H<sub>2</sub>S). The pH of the sample must be raised to convert most of the H<sub>2</sub>S and bisulfide into sulfide ion. The S<sup>2-</sup> proportion of the total sulfide varies from 0% at pH 9 to 100% at pH 15, see Figure 3.1. The pH sensor provides the pH value needed to calculate the total amount of sulfides present in the water. After the caustic, 16% KOH, has been added and the sulfide measurement made, the sample is neutralized with 6.5% HCl to bring the pH back into the neutral range. The reaction, HCl + KOH → KCl + H<sub>2</sub>O, hydrochloric acid plus potassium hydroxide forms potassium chloride and water which can be sent to the drain or added back to the sample water.

### 3.3.2 DISSOCIATION FACTOR

The dissociation factor is the pH correction factor. It is the equilibrium of the Sulfide sensor based in Figure 3.1, the pka. The pKa of the sulfide sensor is set in the CA900 as 12.9 as its equilibrium. Solutions near pKa, no correction needed.

Dissociation Factor x ppm value of the Calibration Solution = Calibration Value

5 ppm Calibration Value at 12.70 pH. Example: 0.5991 x 5.00 ppm = 2.995 ppm

50 ppm Calibration Value. Example: 0.5991 x 50 ppm = 29.955 ppm

These values are what is entered into the CA900 when performing a 2 point calibration. On some version of the CA900 Sulfide analyzer, this factor is already done for you in the analyzer and no Adjustment is needed. To see if software is available for your version of analyzer, please contact the factory. You can also use the chart below for quick reference.

### 3.3.3 DISSOCIATION FACTOR TABLE pH CORRECTION

12.60	0.653	12.70	0.5991	12.80	0.5428	12.90	0.4853	13.00	0.4283
12.61	0.6477	12.71	0.5936	12.81	0.5371	12.91	0.4796		
12.62	0.6425	12.72	0.588	12.82	0.5313	12.92	0.4738		
12.63	0.6372	12.73	0.5824	12.83	0.5256	12.93	0.4681		
12.64	0.6318	12.74	0.5768	12.84	0.5199	12.94	0.4624		
12.65	0.6264	12.75	0.5712	12.85	0.5141	12.95	0.4567		
12.66	0.621	12.76	0.5655	12.86	0.5084	12.96	0.451		
12.67	0.6156	12.77	0.5599	12.87	0.5026	12.97	0.4453		
12.68	0.6101	12.78	0.5542	12.88	0.4968	12.98	0.4396		
12.69	0.6046	12.79	0.5485	12.89	0.4911	12.99	0.4339		

### 3.3.4 PRIMING THE ANALYZER BEFORE START

Before the start of the analysis cycle RUN, the CA900 Sulfide Analyzer must be primed of Sample, and both Reagents. This will ensure proper analysis cycle of the analyzer and eliminate air bubbles in the line.

Refer to section 7.4.2 BASE SCREEN B for priming functions.

**8:26:04 am**  **REMOTE** **System HOLD** **Timed Relay HOLD**  
Mon Jul 24, 2023 **Datalog**

**Step 1 of 12** **Runtime 0 hr. 00 min. 28 sec.**

**End**  
**SULFIDE**  
**pH COMP'D**  
**0 ppb**

**Sensor 1** pH 6.99 pH  
**Sensor 2** S-- 0 ppb

**Acid 7.50 % HCl** **Caustic 16.00 % KOH**

**Sample Pump**  
**Sample**  
**Mixer**  
**Drain**

**English**

**B** **← RUN MAINT MENU →**

**RLY 1 2 3 4**  
**1 2 3 4**

## 4.0 COMPONENTS

The CA900 Sulfide Analyzer has two distinct sections:

1. The **Electrical Section** including power supply, microprocessor controller, I/O and touch screen interface which are located in the Upper Compartment.

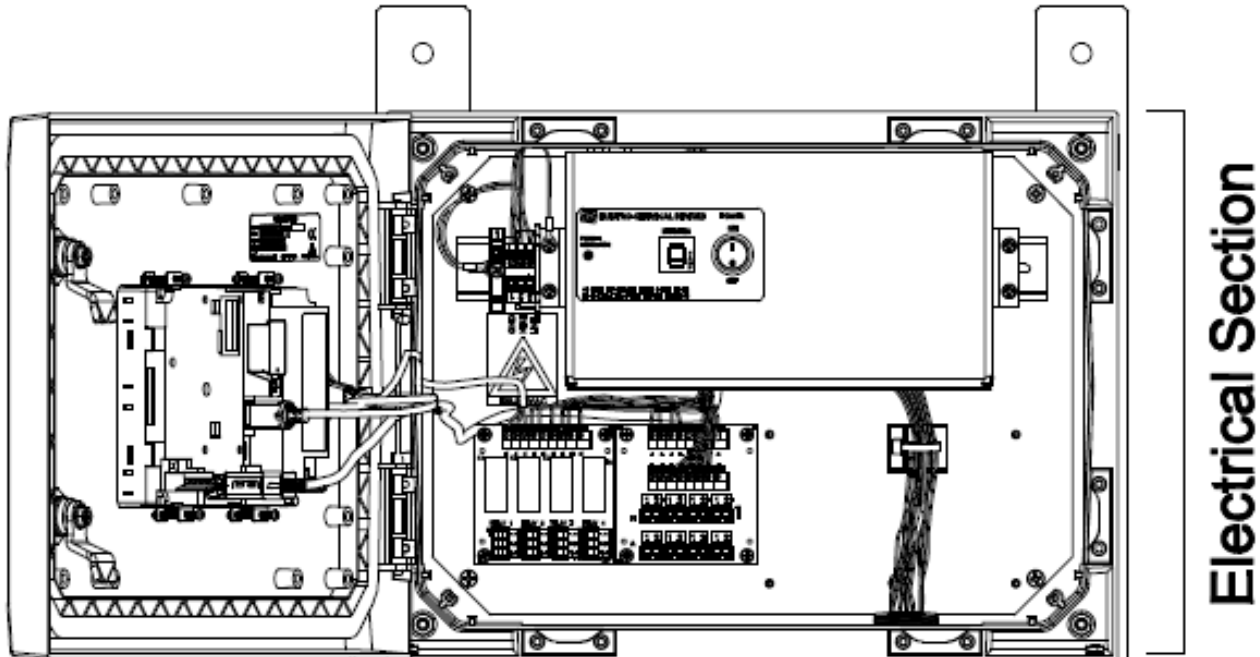

2. The **Liquids Section** which includes all of the liquid handling equipment and is located in the Lower compartment.

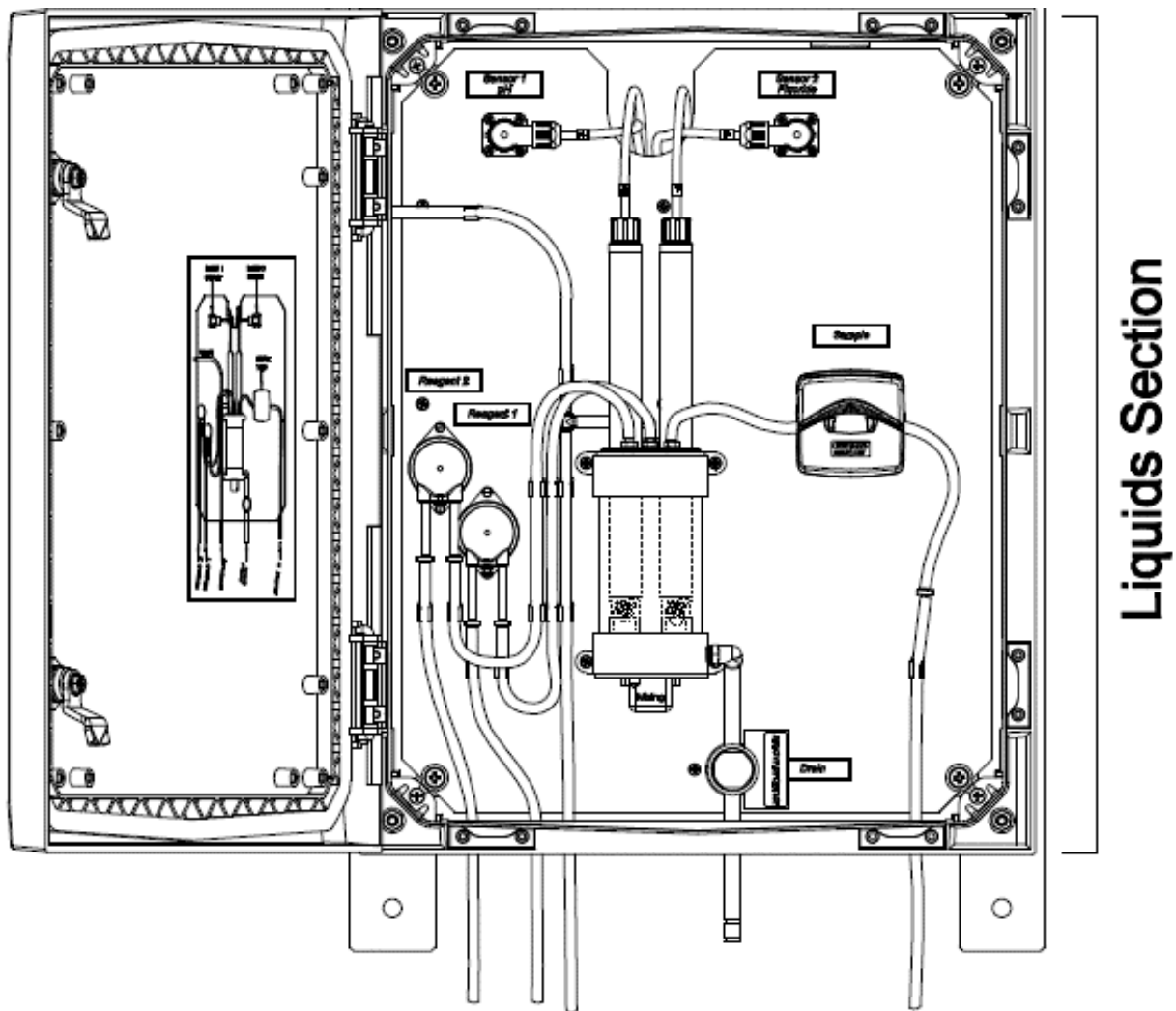
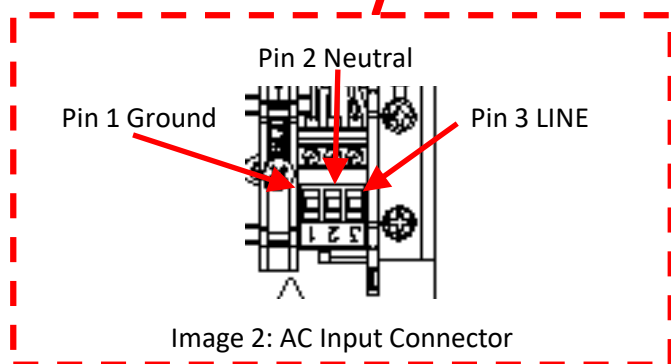
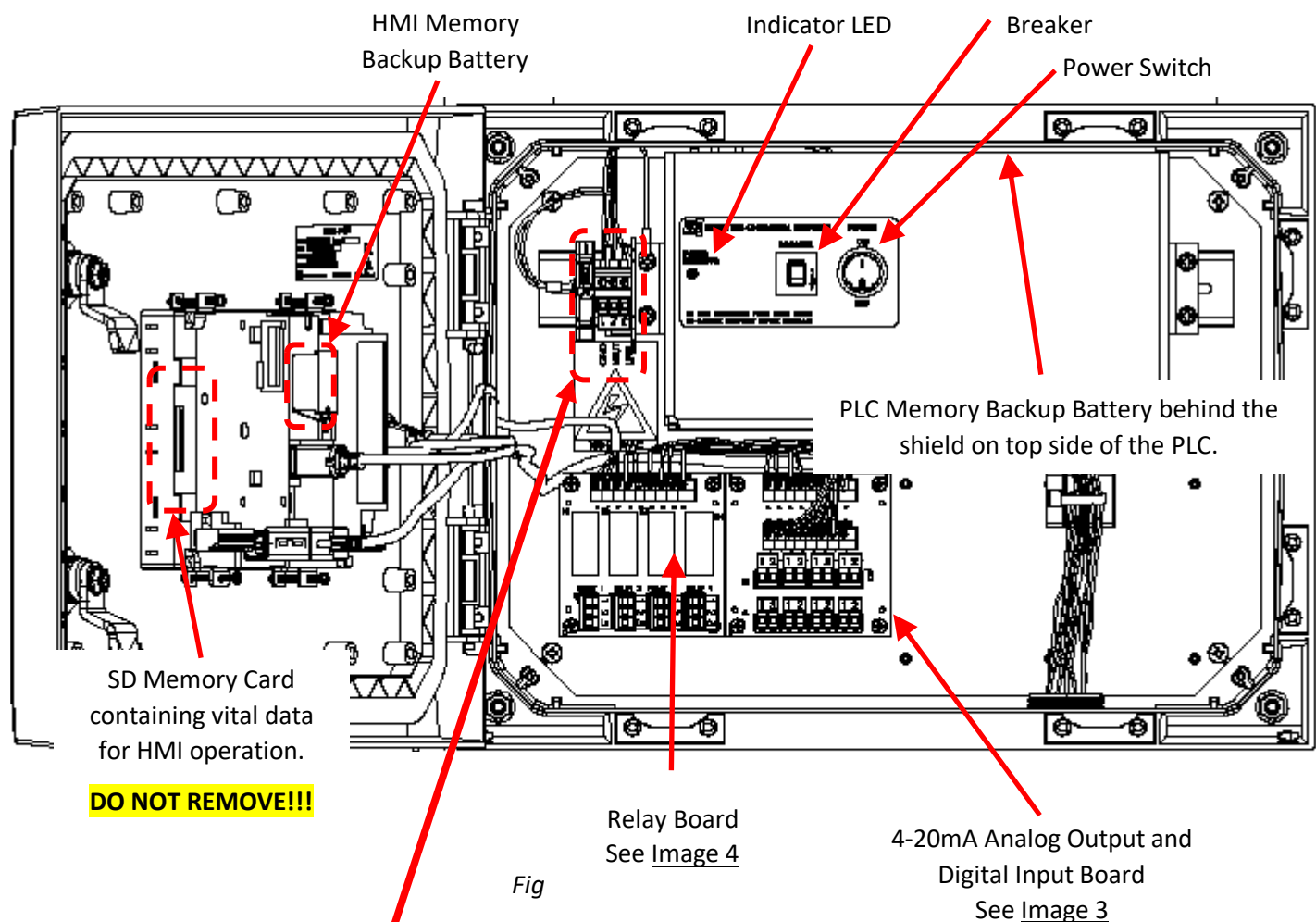

Image 1: Internal Sections

## 4.1 ELECTRICAL SECTION

The microprocessor based controller and its PCB assembly are located in the electronic section. The controller handles all analyzer operations. Collecting all the information and data coming from the different analyzer devices and controls all I/O dialogue with the user touch screen interface and data transfer equipment.



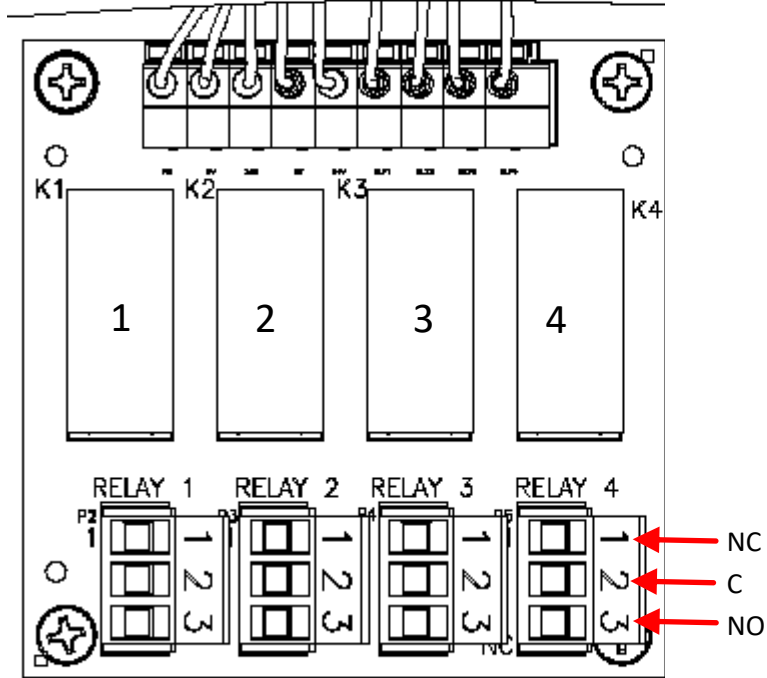

Image 4: Relay Board  
Four SPDT 15A 250VAC Relays

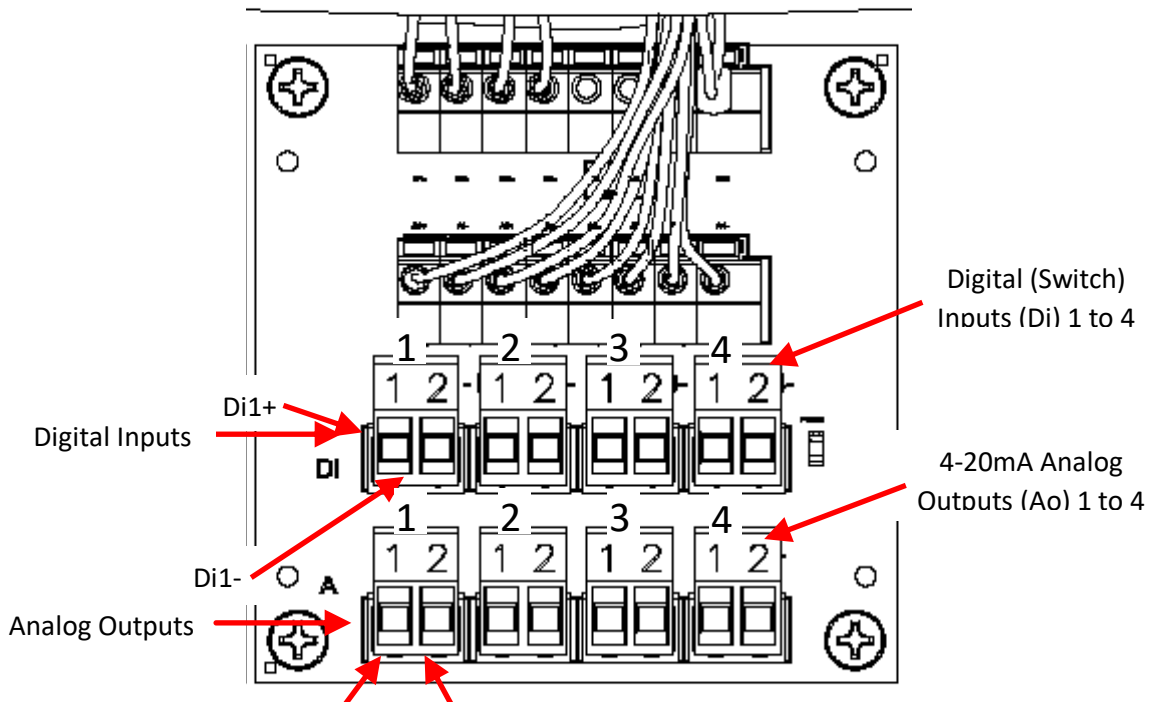

Image 3: 4-20mA Analog Output and Digital Input Board



## 4.2 LIQUIDS SECTION

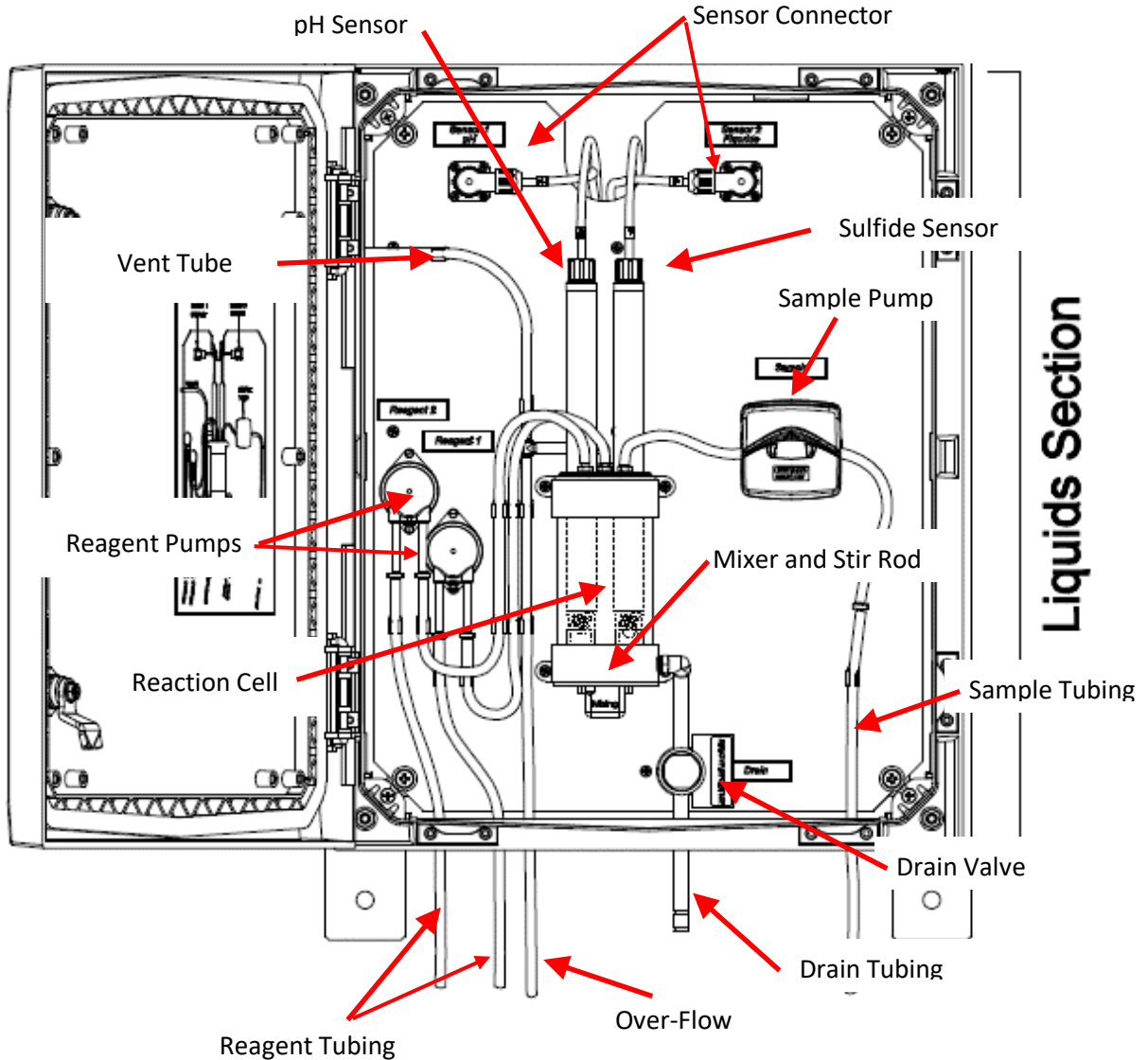

Image 5: Liquids Section



**THE SAMPLE AND REAGENT INPUT MUST BE AT ATMOSPHERIC PRESSURE**

Failure to do so will cause tubing rupture and over-filling of the Reaction Cell which will cause incorrect readings. In addition, the Reagent could be damaged.



**THE DRAIN OUTPUT MUST BE AT ATMOSPHERIC PRESSURE**

Failure to drain will result causing over-filling of the Reaction Cell which will cause incorrect readings and eventually Reaction Cell over-flow.

#### 4.2.1 PUMPS

There are two peristaltic pumps in the Liquids Section that are used for drawing a sample to be tested (Sample Pump) and the other for dispensing a reagent to the sampled liquid (Reagent Pump). Peristaltic pumps work by impinging a small section of tube and pushing along a small quantity of liquid. After a while (depending on use), the impinged tubing will flatten out and need replacement which is characterized by incomplete fills. The Sample Pump's front hinges up allowing access to the tubing for replacement, whereas, the Reagent Pump blue cassette (the front) rotates approximately 1/8 turn and pull straight out for replacement. Use only ECD tubing and replacement items.

#### 4.2.2 DRAIN VALVE

A normally-closed drain (pinch) valve is used to control the draining of the reaction cell. When the valve is actuated it opens and drains the cell. The pinching jaws are sized for 3/8" O.D. Norprene® tubing. The size and material of the tubing is VERY IMPORTANT, use only ECD spares. This tubing should be checked regularly for proper sealing.

#### 4.2.3 REACTION CELL

The reaction cell is the vessel where the sample and reagent are added and mixed. The Sulfide and pH sensor is inserted through an opening on the top of the reaction cell where the sensor electrode is submerged in the sample mixture and measures the Sample solution. Inside the reaction cell is a magnetic bar that is spun on its center axis by the stirring motor immediately below the reaction cell. The assembly is like a laboratory stirring plate.

#### 4.2.4 SULFIDE SENSOR

The Sulfide sensor has two parts: the sensor body with electronics in a 10-inch stainless steel tube and the Sulfide sensor electrode (screwed in to the open end of the sensor body). The sensor uses the Sulfide electrode to measure the concentration. When not in use, the electrode (can be still attached to the sensor) should be kept wet with ECD booting solution (best) or at a minimum tap water.

The Sulfide sensor is connected to be panel and electronics via a circular connector.

1. To connect, simply line-up the indicators on the male (on the sensor cable) and female (on the panel) connectors then push the male sensor connector to mate, The locking ring on the male connector will rotate ¼ turn then snap back when a proper mate is achieved.
2. To disconnect, simply turn the locking ring on the male connector ¼ turn which will push the male connector free of the panel mounted female connector.

#### 4.2.5 PH SENSOR

The pH sensor has two parts: the sensor body with electronics in a 10-inch stainless steel tube and the Sulfide sensor electrode (screwed in to the open end of the sensor body). The sensor uses the Sulfide electrode to measure the concentration. When not in use, the electrode (can be still attached to the sensor) should be kept wet with ECD booting solution (best) or at a minimum tap water.

The pH sensor is connected to be panel and electronics via a circular connector.

3. To connect, simply line-up the indicators on the male (on the sensor cable) and female (on the panel) connectors then push the male sensor connector to mate, The locking ring on the male connector will rotate ¼ turn then snap back when a proper mate is achieved.
4. To disconnect, simply turn the locking ring on the male connector ¼ turn which will push the male connector free of the panel mounted female connector.



**DO NOT USE DE-IODIZED WATER TO STORE THE SENSOR ELECTRODE.**

De-ionized water will cause damage to the sensor electrode and will require replacement. The sensor's electrode is shipped with a black boot on the end with booting solution, this boot can be refilled and used again.

## 5.0 MOUNTING

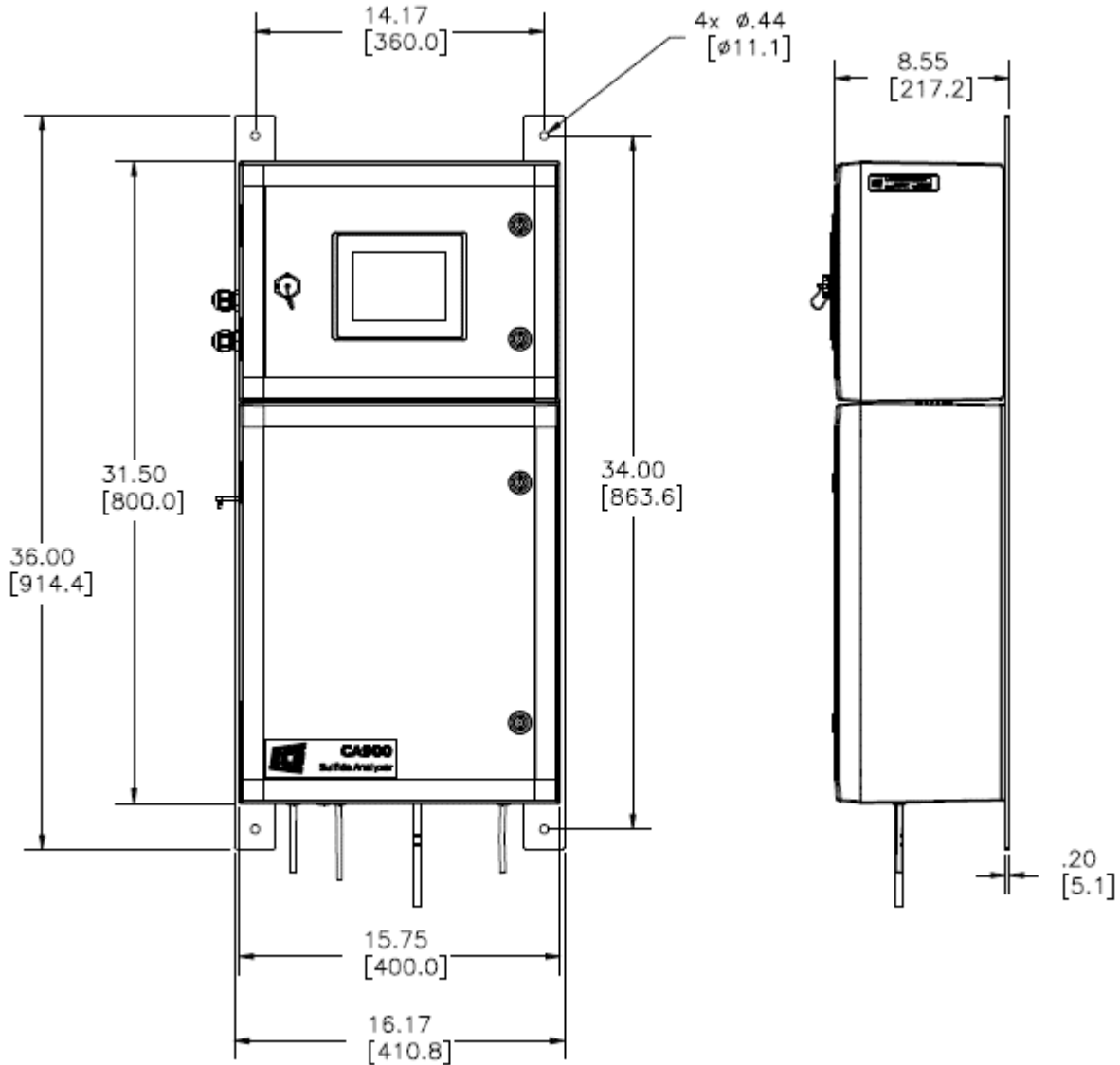

Mount the CA900 in a location where there is easy access to the controller and sensors, installing the system in an area where vibrations, electromagnetic, and radio frequency interference are minimized or absent. Do not mount in direct sunlight or areas of extreme heat (temperature > 50°C (122°F)). The CA900 is suitable for outdoor use avoiding direct water spray or rain, as such, it is best to mount it with a protective cover or sunshield to prevent discoloring over the years.



## 5.1 WIRING

Electrical wiring should only be conducted by qualified personnel.

Before starting to install any wiring, please be aware of the following;

	Warning: RISK OF ELECTRICAL SHOCK
	Disconnect Power before opening instrument.
	WARNING: Electrical installation must be in accordance with the National Electrical Code (ANSI/NFPA-70), Canadian Electrical Code and/or any other applicable national or local codes.

### 5.1.1 WIRING, POWER

ECD recommends using a thermoplastic, outdoor sunlight resistant jacketed cable, wet location rated, and ½” flexible conduit. The power should be hard wired with a switch or breaker to disconnect the controller from the main power supply. Install the switch or breaker near the controller, and label it as the Power Switch for the controller.

#### 110/220 VAC

Attach power cable as shown in [Image 2 Page 21](#). Feed the cable through one of the gland fittings on the left hand side of the CA900. Tighten the cable gland to provide a good seal to the cable. The instrument can be powered up at this point with no harm to the controller, but it is best to wait until the sensor is installed.

### 5.1.2 WIRING, ANALOG OUTPUTS (Ao)

The industry standard 4 to 20mA Analog Outputs (Ao) are shown in [Image 3 Page 22](#). The analog outputs are labeled as **A1+(-)** to **A4+(-)**. **A1+** is located on the right side of the circuit board with **A4-** on the left side of the board.



### 5.1.3 WIRING, CONTACT RELAY OUTPUTS

The standard configuration has 8 SPST 230V 15A relays that can be wired either **normally open (NO)** or **normally closed (NC)**. Diagram of the relays can be seen in [Image 4 Page 21](#).

### 5.1.4 WIRING, DIGITAL INPUT (Di)

The Digital Inputs (Di) are shown in [Image 3 Page 21](#). The Digital inputs are labeled **Di1+ (-)** to **Di4+ (-)**. **Di1+** is located on the right side of the circuit board with **Di4-** on the left side of the board. The Digital Inputs are used by connecting the + and – of one of the Di channels together to provide an ON indication to the system, disconnecting or opening indicates the channel is OFF.

## 6.0 REAGENTS AND BUFFERS

	<b>DANGER: Read any precautions and the (SDS) datasheets, wear protective gloves, clothes and glasses before handling chemical products.</b>
	<b>Hazard of severe burns or injury due to handling of dangerous chemicals</b>

The CA900 Sulfide Analyzer uses the following reagents:

Reagent 1 – 16% Potassium Hydroxide a highly caustic reagent and can be purchased in sizes of 500ml, 1L, 2L, 5L, and 20L.

Reagent 2 – 7.5% Hydrochloric Acid a highly acidic reagent and can be purchased in sizes of 500ml, 1L, 2L, 5L, and 20L.

The CA900 Sulfide Analyzer uses any of 2 the following calibration standards and should be selected based on the range of the Analyzer or 100 ppm whichever is lower. For example a range of 0 to 10 ppm should use the full scale standard of 10 ppm and one decade lower of 1 ppm. Standards are available as follows in 500 mL volumes:

1 ppm, 3 ppm, 5 ppm, 10 ppm, 30 ppm, 50, ppm, 100 ppm

The Analyzer utilizes a pH electrode in addition to the Sulfide sensor. pH 7 and pH 4 Buffer is needed to calibrate the pH sensor.

Read all SDS data sheets before preparing the reagents.

**Use good laboratory technique. Wear safety goggles, gloves and protective clothing when preparing the reagents, calibration solutions or cleaning solutions.**

**Mind all Hazard and Poison labels.**

Pre-made reagents and solutions are available from ECD. The part #s for the reagents can be found in Appendix B Page 81.

## 7.0 OPERATION

The ECD Model CA900 Sulfide Analyzer is designed for the online continuous measurement of Sulfide in a general purpose industrial environment. The CA900 uses an ECD sensor equipped with a ECD Sulfide electrode to measure the Sulfide content of a sampled process stream mixed with a reagent to enhance the free Sulfide ions. The measurement identity is contained in the Sensor's memory. The measured Sulfide is data logged and can be used as set-points.

Programming or setup of the CA900 is accomplished via the color LCD touch panel mounted on the front of the housing. The resistive touch panel requires more force to actuate selections than a typical cell phone capacitive touch screen; therefore, don't expect to soft-touch the screen button and get an action. Resistive touch screens have better characteristics suited for an industrial environment than capacitive touch screens; for example, resistance to false actuations by water droplets. Programming is done using a menu system that presents options to the user graphically. All selections are stored in a non-volatile memory for recall during power-up.

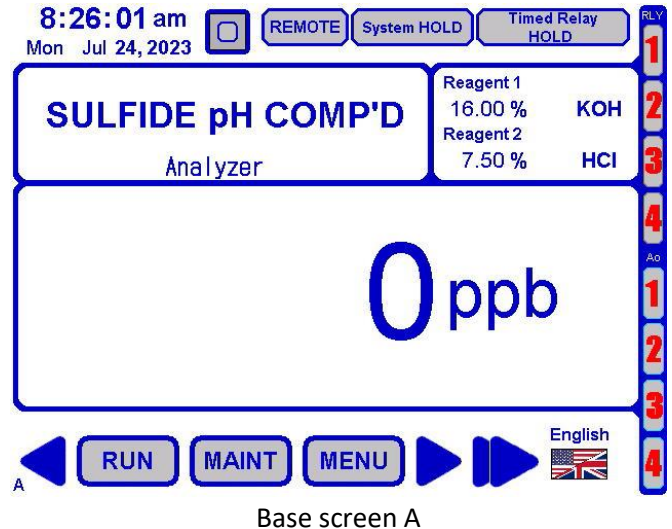

Base screen A



Only press on the Touch Screen using a finger or soft tipped stylus. **NEVER** use any hard object such as keys, screw drivers etc. The Touch Screen will be damaged and will be considered customer abuse thereby rendering the CA900's warranty void.

### 7.1 CONVENTIONS

#### 7.1.1 DEFINITIONS

The following are useful definitions used in the manual and are included for clarity.

1. Base Screen A – The home screen of the CA900 used to display device information. Base Screen A is where everything defaults or times out back to.
2. Device – Any of the various CA900 resources available for the user, ex. Sensors, Relays etc.
3. Sensor – The metal or plastic tube (body) where a sensor element is screwed into and is connected directly to the CA900 via a 4 conductor (wire) cable.
4. Sensor Element or Electrode – The cartridge that is screwed into the sensor end, usually an ISE or pion sensor element meant for millivolt (mV) sensors.
5. ISE – Ion Selective Electrode.
6. Ao – Analog Output (4mA -20mA)
7. Di – Digital Input (switch input)
8. Screen – The Color LCD Panel that is the primary output to the user.
9. Touch Screen – The clear resistive membrane that is located on the face of the Screen and is the primary input for the user.
10. Popup Screen – Screens that are activated by buttons on the Base or other Popup Screens. Popup screens allow device configuration and access to device information. These screens will overlay Base Screen A.
11. Pulldown Screen - Screens that present a list of user choices and are activated from either a Popup or another Pulldown Screens. There isn't a title bar with screen name, the screen number is at the bottom and the Pulldown Screen over-lays the activating screen.

12. Title Bar – The bar at the top of a Popup Screen that has the screen number and name. Pulldown Screens don't have a title bar.
13. Screen Numbers – Numbers in the title bar (Popup Screens) or at the bottom left (Pulldown Screens) that can be used to reference the screen instead of the screen name.

### 7.1.2 COLORS

Various colors are used on the LCD panel to convey the operation of the CA900 to the user.

1. Gray – The button or action is not available.
2. Light Blue – The parameter can be modified or denotes the current selection.
3. Green – The parameter or device has been activated.
4. Yellow or Orange – A warning that an action is occurring or the user is about to make a system change.

### 7.1.3 BUTTONS AND INDICATORS

Buttons are graphical elements on the Screen that can be activated by pressing the touch screen area of the button. Indicators are also graphical elements on the Screen but are only activated by a CA900's parameter, pressing an indicator don't result in any action. Buttons can also be Indicators but retain the feature of touch activation.

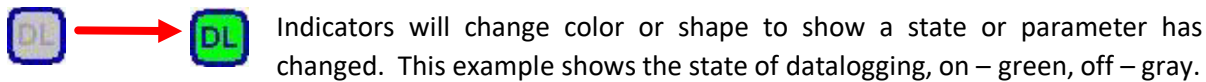
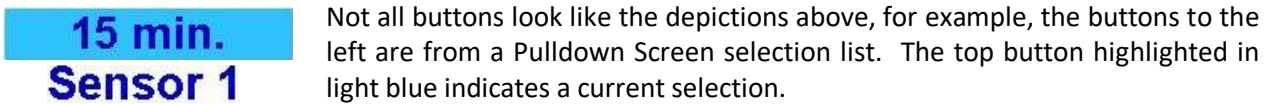
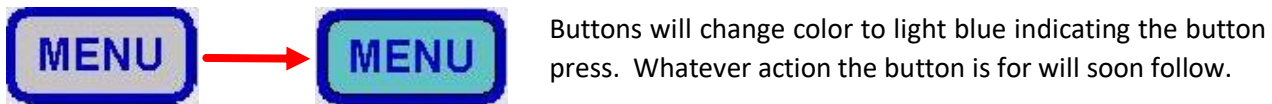

#### 7.1.3.1 Special Buttons

The EXIT and BACK buttons are on most if not all Popup Screens and have specific action relating to the menu screens.



The bar graph at the bottom of the EXIT button corresponds to the amount of time left before the Popup Screen is automatically closed. The bar turns red when there is ~ 20% of the time remaining before the screen back light will turn off.

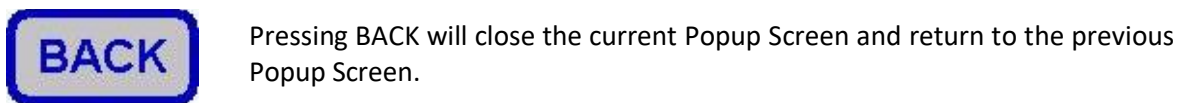

### 7.1.4 POPUP SCREENS

Popup Screens have a title bar with screen name and screen number and are activated by buttons on the Base or other Popup Screens. Popup Screens allow device configuration and access to device information. The Popup Screen will close after a determined interval setup in the Display Configuration.

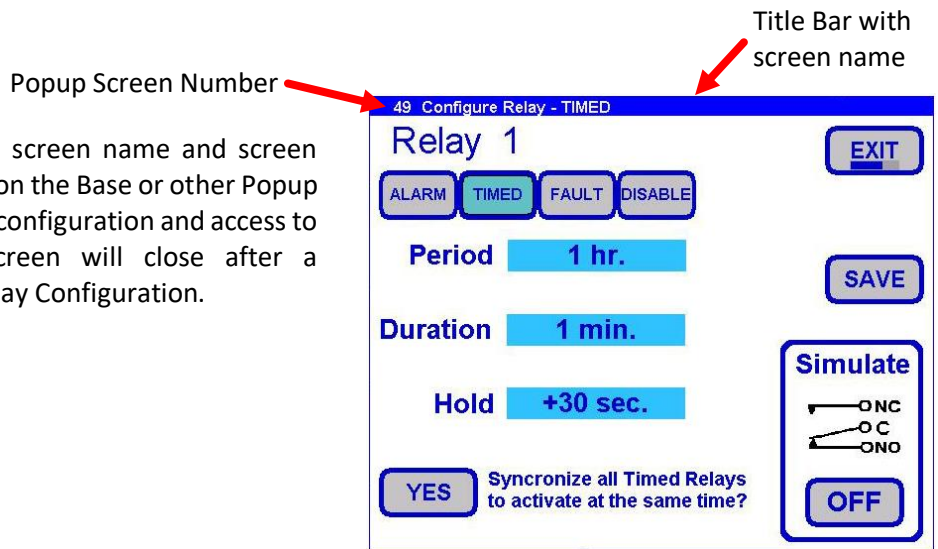

### 7.1.5 PULLDOWN SCREENS

Pulldown Screens present a list of user choices and are activated from either a Popup or another Pulldown Screen. There isn't a title bar with screen name but the screen number is at the bottom. The Pulldown Screen over-lays the activating screen and closes after 7 seconds if no selection has been made.

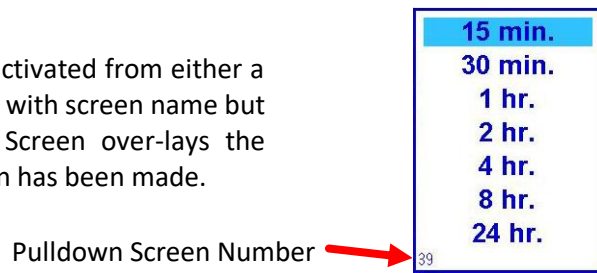

## 7.2 STARTUP SCREEN

The Startup Screen is the first screen presented after power is applied to the CA900. While the Startup Screen is displayed, the system is initializing and the sensor inputs are being scanned for the presence of a Sulfide sensor. Once the Sulfide sensor is found, it is always polled for data and cannot be disabled.



Indicates the system is initializing and will turn all green when completed.



## 7.3 MENU MAP

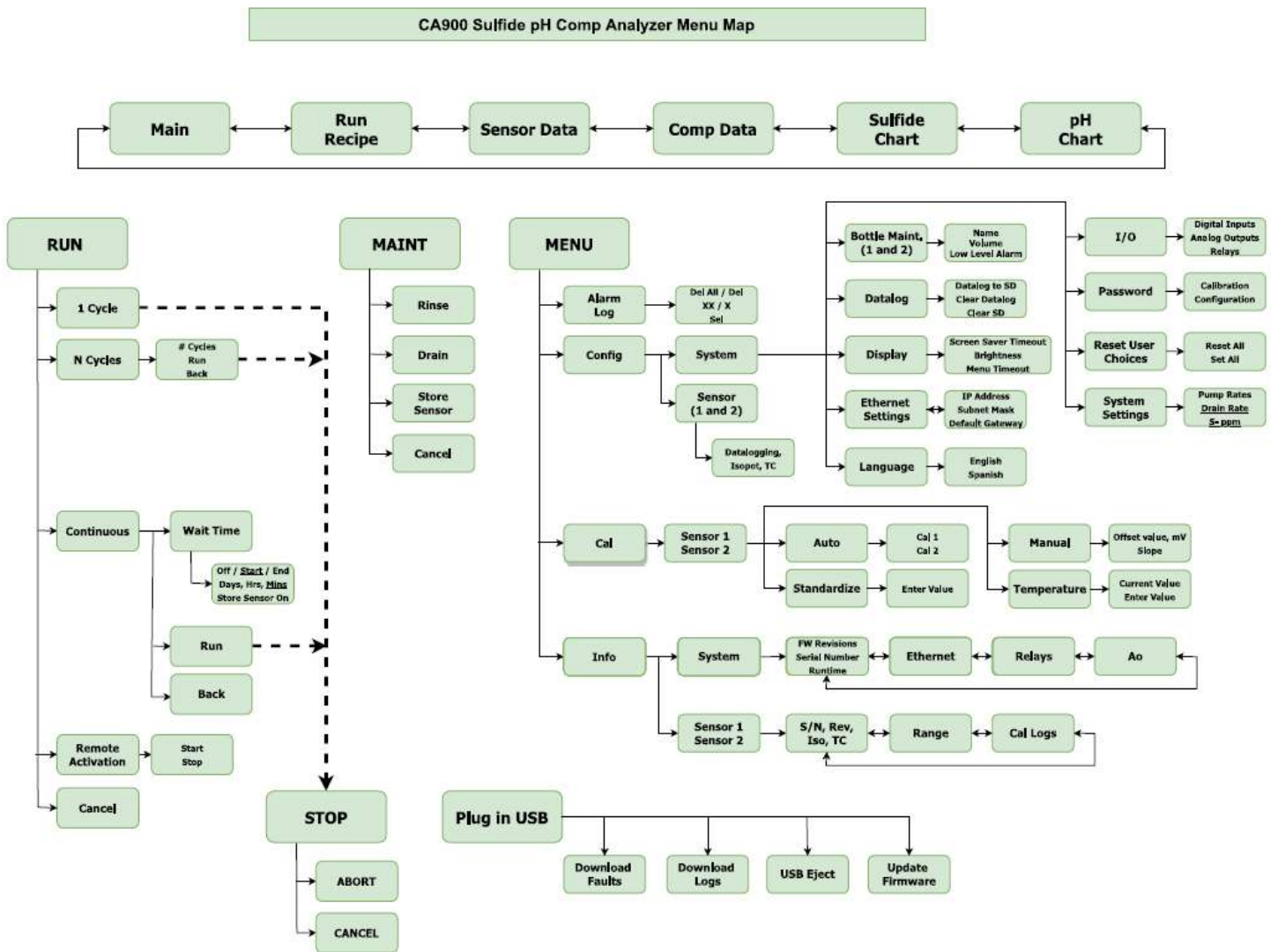

## 7.4 BASE SCREENS

The Left and Right arrows are used to navigate between the four base screens providing views of additional system and run information.

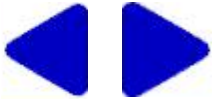

5 inch, 640 x 480 pixel screen

Base Screen letter designations are located at the left bottom of the screen

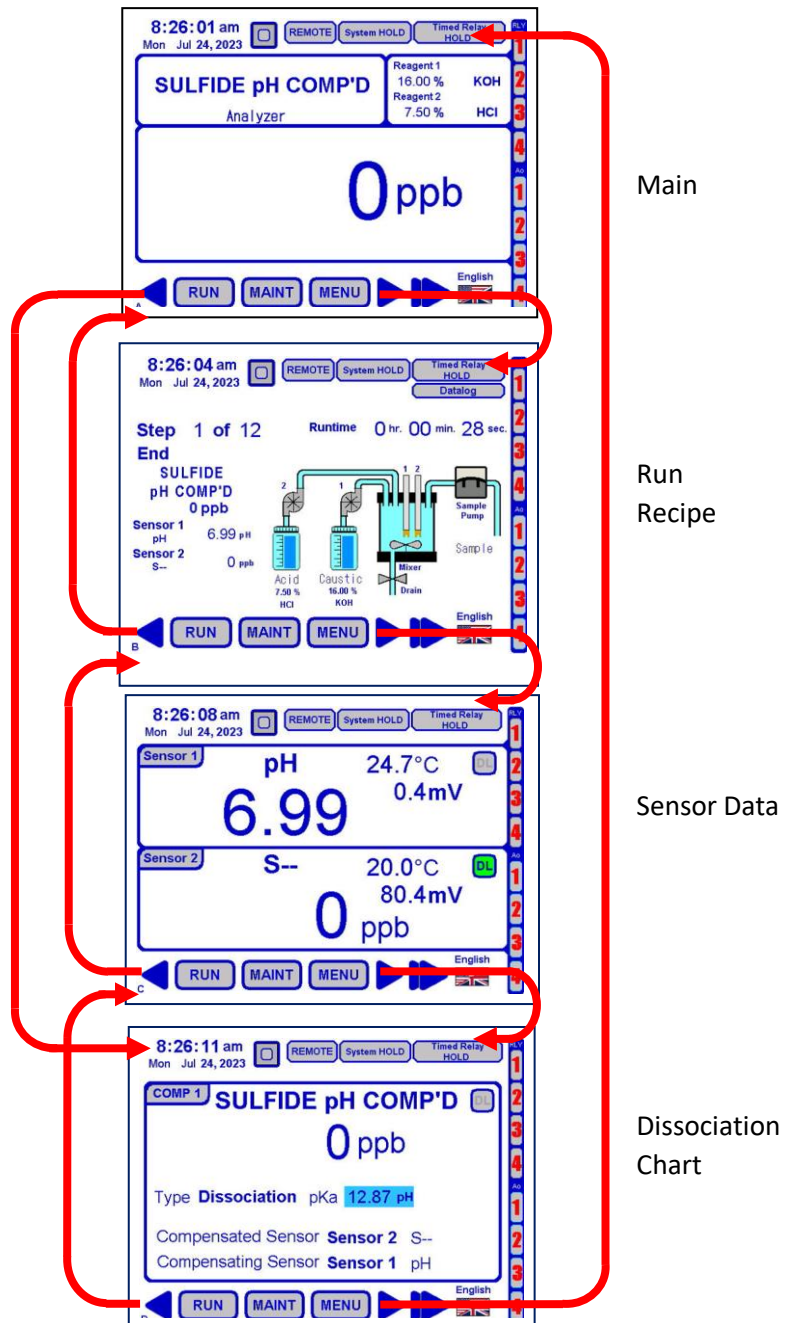

### 7.4.1 BASE SCREEN A (MAIN)

Once the screen saver has been turned on, a checkmark will appear here with a dark blue background shortening in height corresponding to the timeout set in Popup Screen 13. At approximately 20% remaining time, the dark blue will turn to red; after which the display backlight will turn off. Pressing anywhere on the screen will turn the backlight back on. Pressing anywhere on the screen during the screen saver timeout will restart the timer.

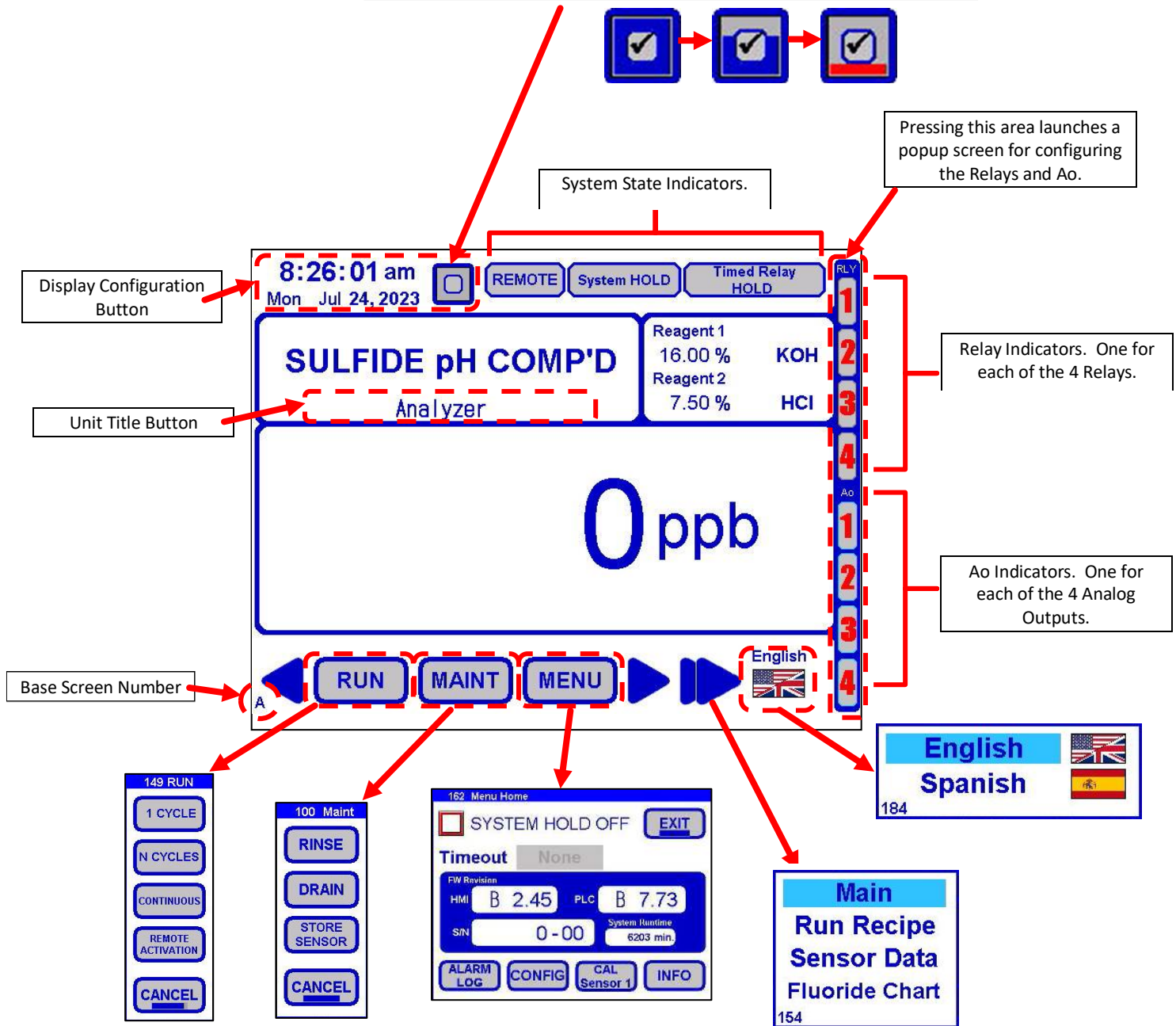

### 7.4.1.1 Base Screen A (Main Run)

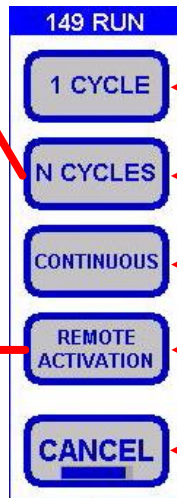
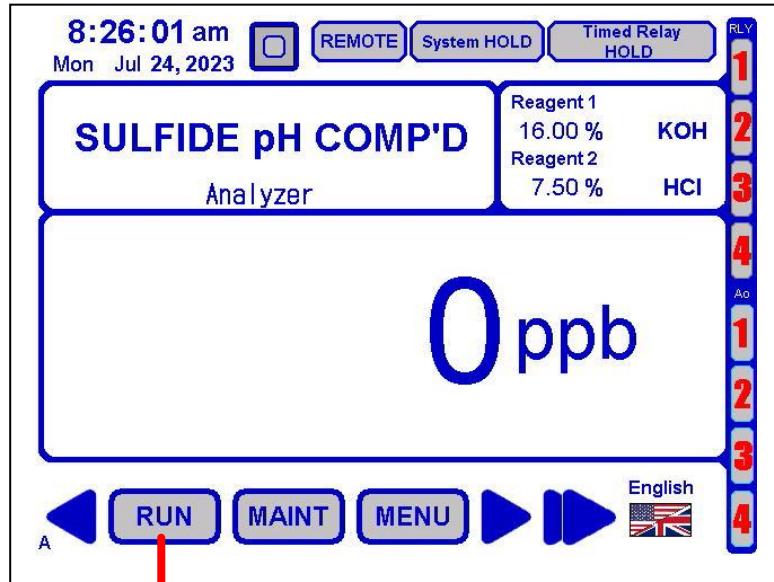

- Runs 1 Recipe Cycle
- Runs n Recipe Cycles as input by the user
- Runs continuous recipe cycles until aborted
- Start/Stop Remote Activation
- Cancels RUN type selection

Remote Activation allows the operator to use Input 1 for activating a recipe run from another location or a button outside the housing.

Input 1 can still be employed with a relay for local indication, for example

7.4.1.2 Main Screen A (Run Continuous)

The main screen displays the time 8:26:01 am on Mon Jul 24, 2023. It shows 'SULFIDE pH COMP'D Analyzer' with reagent levels: Reagent 1 at 16.00% (KOH) and Reagent 2 at 7.50% (HCl). The current reading is 0 ppb. A menu on the left lists options: 1 CYCLE, N CYCLES, CONTINUOUS, REMOTE ACTIVATION, and CANCEL. The 'CONTINUOUS' option is highlighted with a red arrow pointing to the 'RUN' button on the main screen.

The '178 Continuous' menu shows the 'OFF' position selected. It features a 'No Wait Time' diagram and 'Run Cycle' settings. The settings are: Day(s) 0, Hr(s) 0, and Min(s) 0. Maximum values are 7 Day(s), 24 Hr(s), and 60 Min(s). Buttons for BACK, RUN, and CLEAR are visible. A checkbox for 'Store Sensor ON' is present.

In the OFF position, the analyzer will run continuously without a wait time between cycles.

Press "RUN" to start continuous cycles.

The '178 Continuous' menu shows the 'START' position selected. It features a 'Wait Time' diagram and 'Run Cycle' settings. The settings are: Day(s) 0, Hr(s) 0, and Min(s) 0. Maximum values are 7 Day(s), 24 Hr(s), and 60 Min(s). Buttons for BACK, RUN, and CLEAR are visible. A checkbox for 'Store Sensor OFF' is present.

In the START position, the analyzer will run continuously based on the user set period of time.

For example, one cycle on average is 5 minutes. Configuring the settings to:

Day(s) = 0  
Hrs(s) = 1  
Min(s) = 0

Means that every (1) hour, the analyzer will run one cycle for 5 minutes and wait an additional 55 minutes before the next cycle begins.

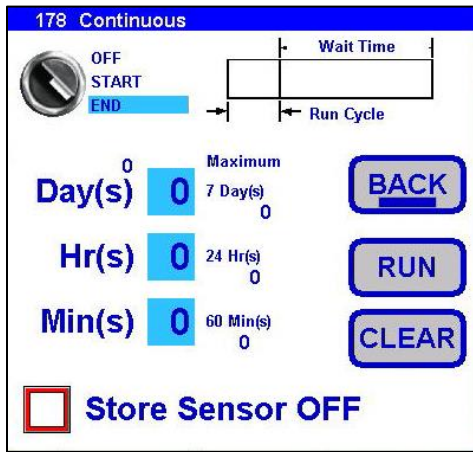

In the END position, the user sets the additional wait time after each cycle.

For example, one cycle on average is 5 minutes.  
Configuring the settings to:

Day(s) = 0  
Hrs(s) = 1  
Min(s) = 0

Means that after a cycle is finished, the analyzer will wait for (1) hour until the next cycle begins.

### 7.4.1.3 Main Screen A1 (Run Recipe)

2:17:33 pm  
Mon Apr 19, 2021

REMOTE System HOLD Timed Relay HOLD

SULFIDE pH COMP'D Analyzer

Reagent 1

0 ppb

1 Cycle Runtime 0 hr. 00 min. 01 sec.

Step 1 of 10 Rinse

English

A1

STOP MAINT MENU

Run Type → 1 Cycle

Recipe Steps → Step 1 of 10 Rinse

Runtime of the recipe run → 0 hr. 00 min. 01 sec.

Current recipe operation → Rinse

The Stop button appears during a recipe run → STOP

MAINT and MENU buttons are de-activated during a recipe run → MAINT MENU

Stops the process and sets up the next → 150 STOP ABORT CANCEL

7.4.2 BASE SCREEN B

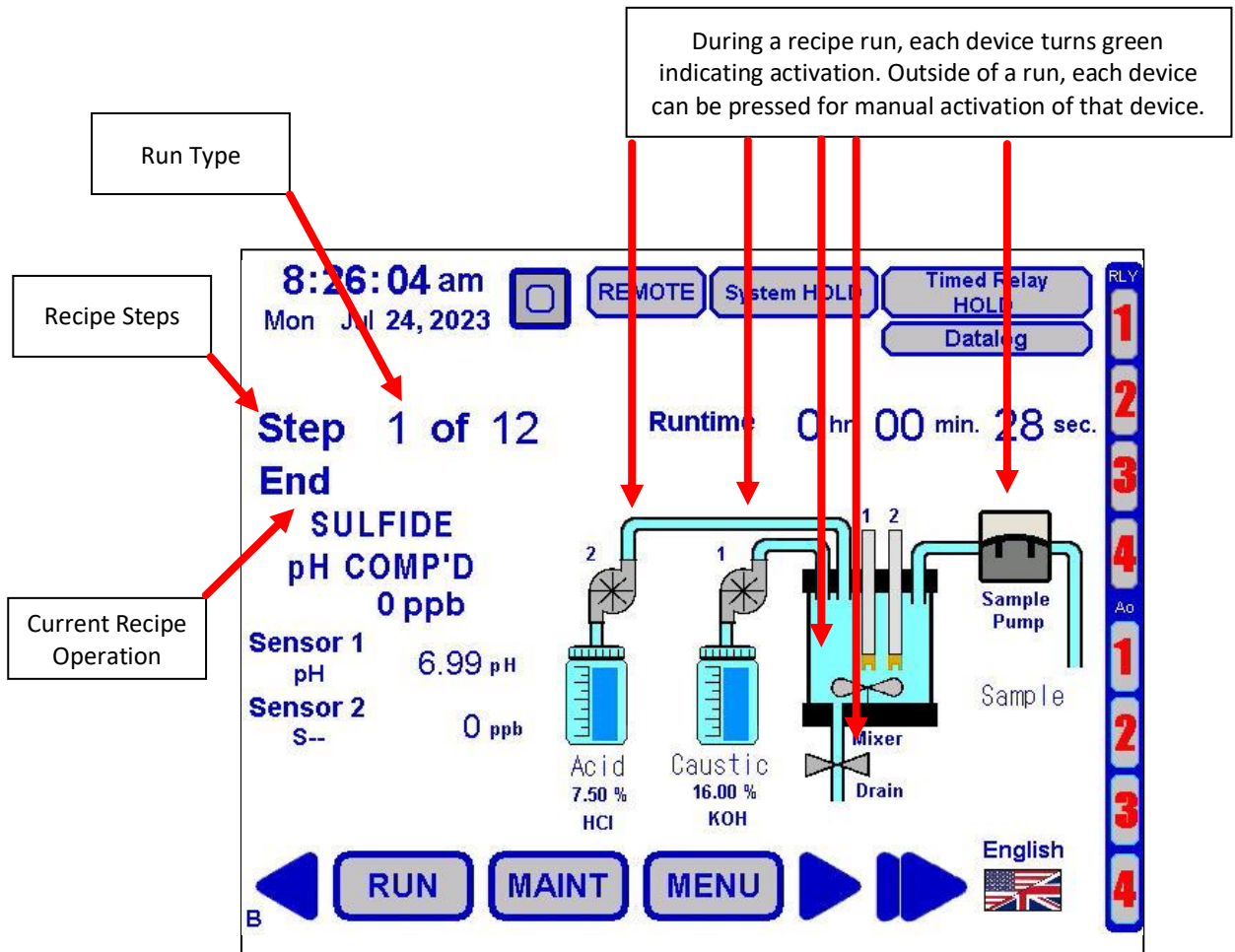

7.4.2.1 Base Screen B (Manual Activation: Sample Pump)

8:26:04 am  
Mon Jul 24, 2023

REMOTE System HOLD Timed Relay HOLD Datalog

Step 1 of 12 Runtime 0 hr. 00 min. 28 sec.

End

SULFIDE  
pH COMP'D  
0 ppb

Sensor 1 pH 6.99 pH  
Sensor 2 S-- 0 ppb

Acid 7.50 % HCl  
Caustic 16.00 % KOH

Mixer Drain

Sample Pump

English

B RUN MAINT MENU

RLY 1 2 3 4 Ao 1 2 3 4

Press on the Sample Pump to Manually Sample a desired quantity of Sample to the cell

180 Prime Pump

Sample Pump CANCEL

Volume To Deliver

Deliver	Delivered
0.0 ml	0.0 ml

00 min. 28 sec.

pH COMP'D  
0 ppb

Sensor 1 pH 6.99 pH  
Sensor 2 S-- 0 ppb

Acid 7.50 % HCl  
Caustic 16.00 % KOH

Mixer Drain

Sample Pump

Sample

English

B RUN MAINT MENU

RLY 1 2 3 4 Ao 1 2 3 4

Press the highlighted area to enter in the desired volume to deliver

Press RUN to start sampling.



7.4.2.2 Base Screen B (Manual Activation: Reagent Pump)

8:26:04 am  
Mon Jul 24, 2023

REMOTE System HOLD Timed Relay HOLD  
Datalog

Step 1 of 12 Runtime 0 hr. 00 min. 28 sec.

End  
SULFIDE  
pH COMP'D  
0 ppb

Sensor 1 pH 6.99 pH  
Sensor 2 S-- 0 ppb

Acid 7.50 % HCl  
Caustic 16.00 % KOH

Sample Pump  
Sample  
Mixer  
Drain

English

B RUN MAINT MENU

RLY 1 2 3 4  
Ao 1 2 3 4

Press on the Reagent Pump to manually deliver a desired quantity of reagent to the cell.  
This function also allows the user to prime the reagent line.

180 Prime Pump

Pump 1

CANCEL

Volume To Deliver

Deliver	Delivered
0.0 ml	0.0 ml

RUN

Press the highlighted area to enter in the desired volume to deliver

Press "RUN" to start the reagent pump/priming the reagent pump.

7.4.2.3 Base Screen B (Manual Activation: Drain)

Press on the Drain to manually drain out the cell.

Press DRAIN to remove all liquid from the cell.

\*Ensure that the electrode tip is submerged with ECD booting solution (best) or at a minimum tap water. If exposed to air for a long period of time, the electrode will dry out and produce erratic results.

7.4.2.4 Base Screen B (Manual Activation: Bottle Maintenance) Reset after every Bottle change

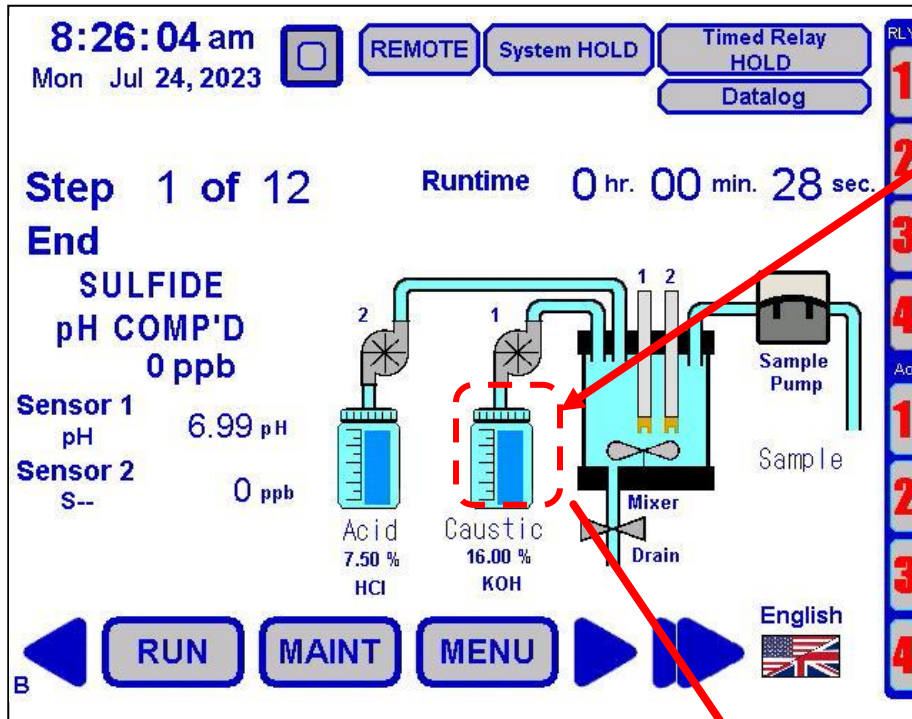

Press on the Reagent Bottle to adjust name, volume and low level alarm settings.

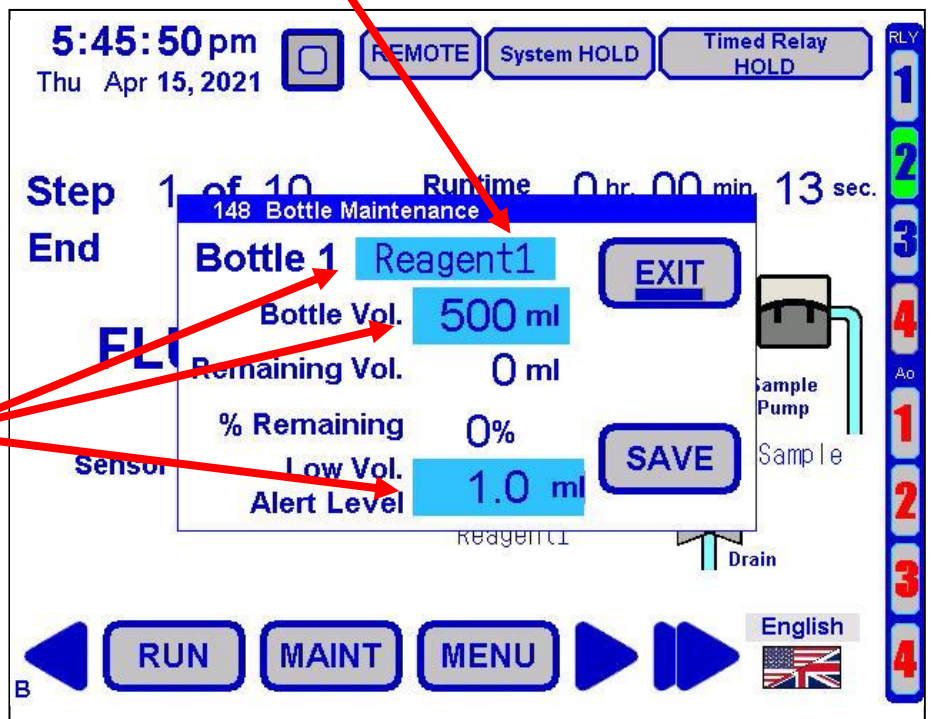

Bottle name, volume and low level alarm can be adjusted.

### 7.4.2.5 Base Screen B (Manual Activation: Mixer)

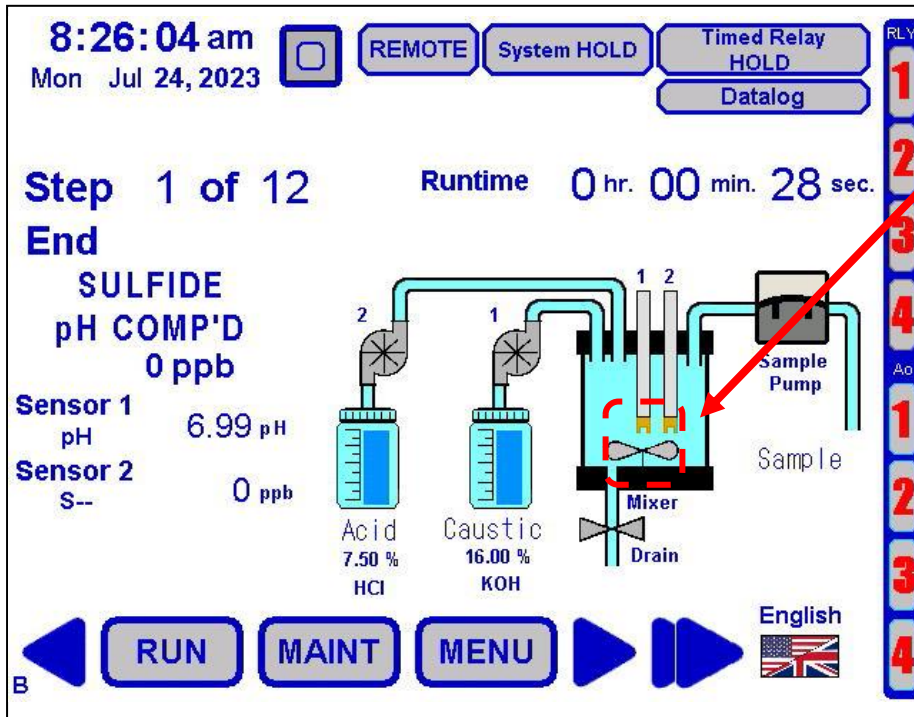

Press on the mixer to activate the stir bar. A popup screen does not appear.

### 7.4.3 BASE SCREEN C (SENSOR DATA)

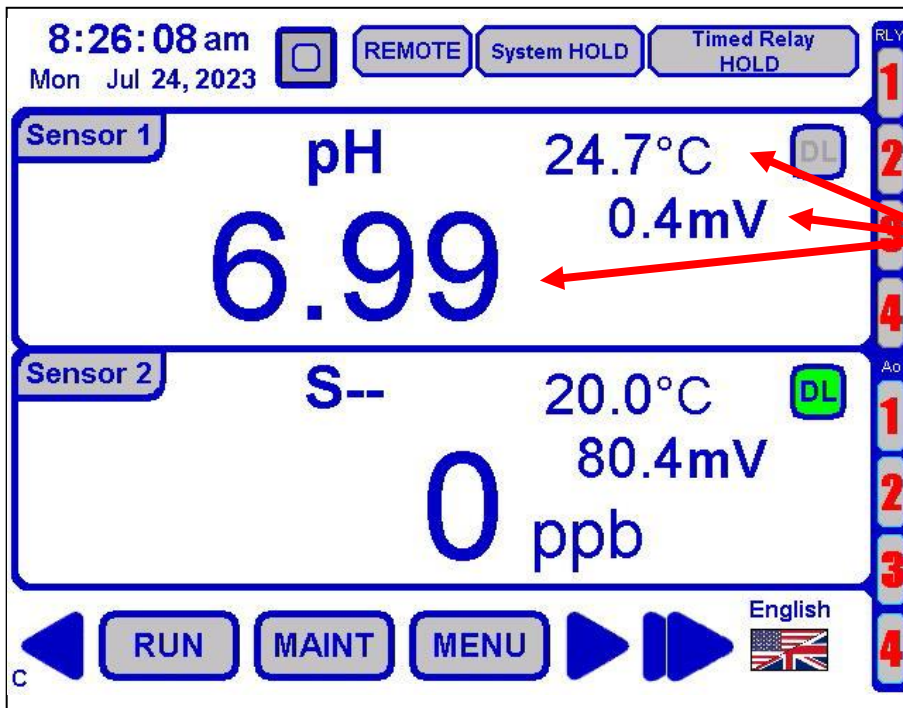

This base screen allows the user to view the sensor data in real time.

Temperature, mV and concentration values can be observed during each recipe.

7.4.4 BASE SCREEN E (SULFIDE CHART)

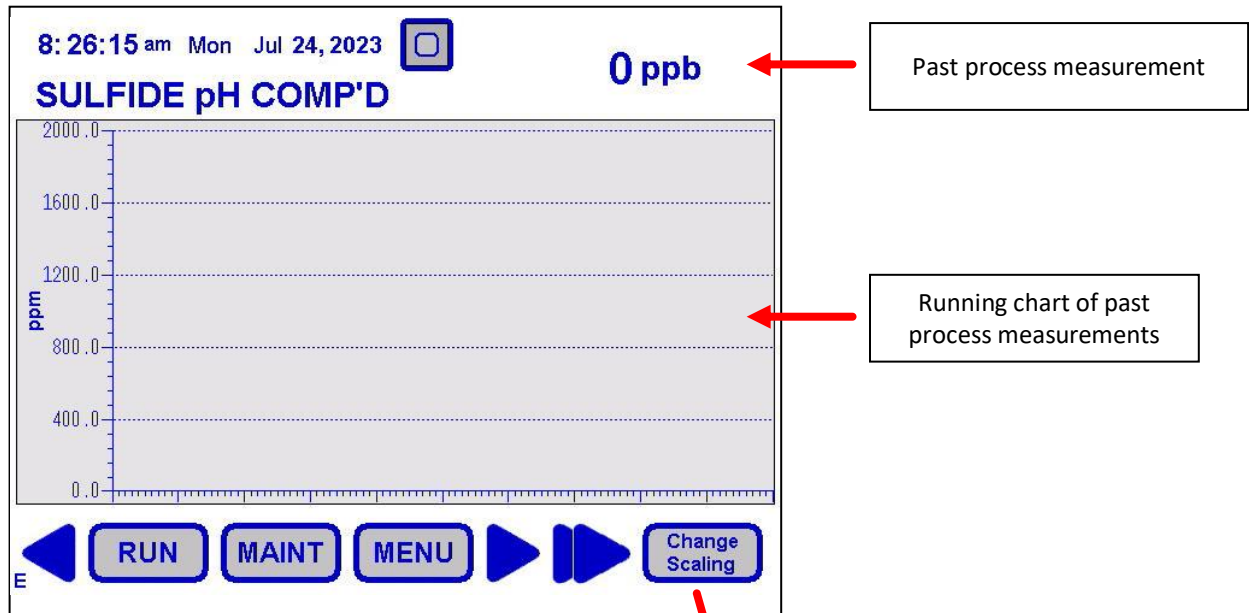

X and Y axis can be adjusted here.

X Axis defines each reading.

Y Axis defines the concentration in ppm.

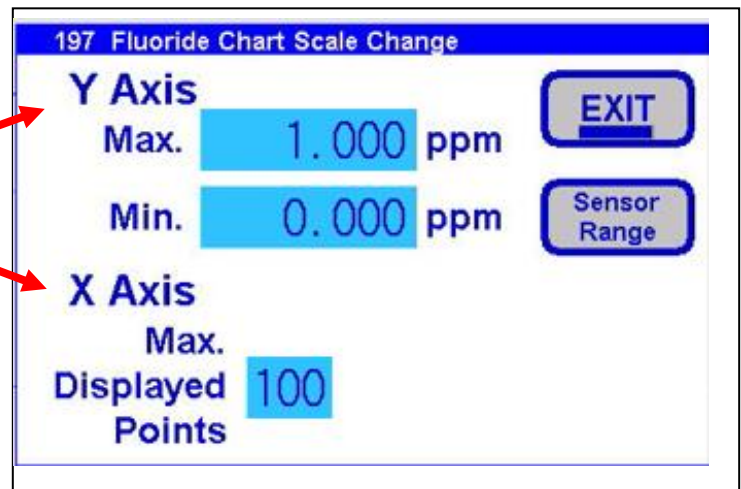

## 7.5 MAINTENANCE MENU AND FUNCTIONS

The maintenance menu allows the user to rinse, drain and store the sensor with sample. Use these functions when performing tubing replacements, hydraulic checks, replacement of the electrode and/or placing the analyzer in standby mode.

### 7.5.1 MAINTENANCE MENU: RINSE

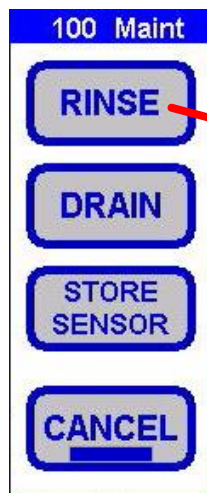
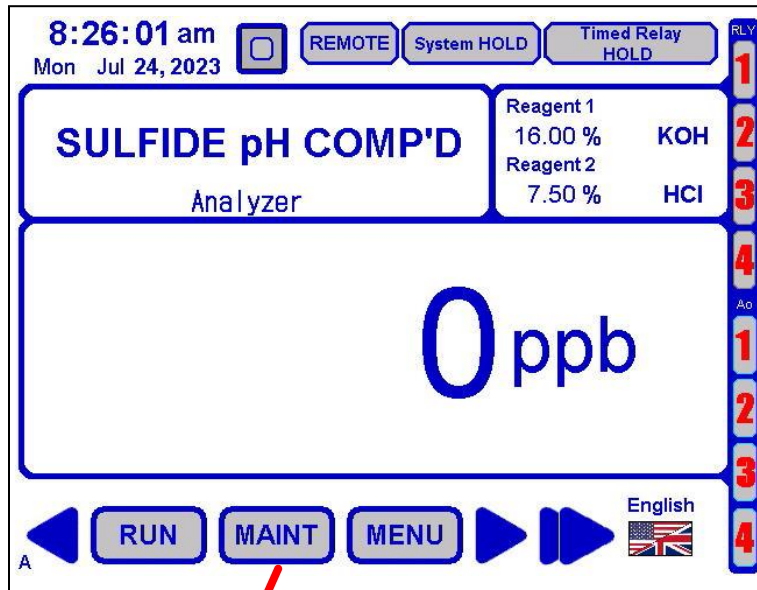

Choosing the function "RINSE" will rinse out the reaction cell and show this Warning screen.

7.5.2 MAINTENANCE MENU: DRAIN

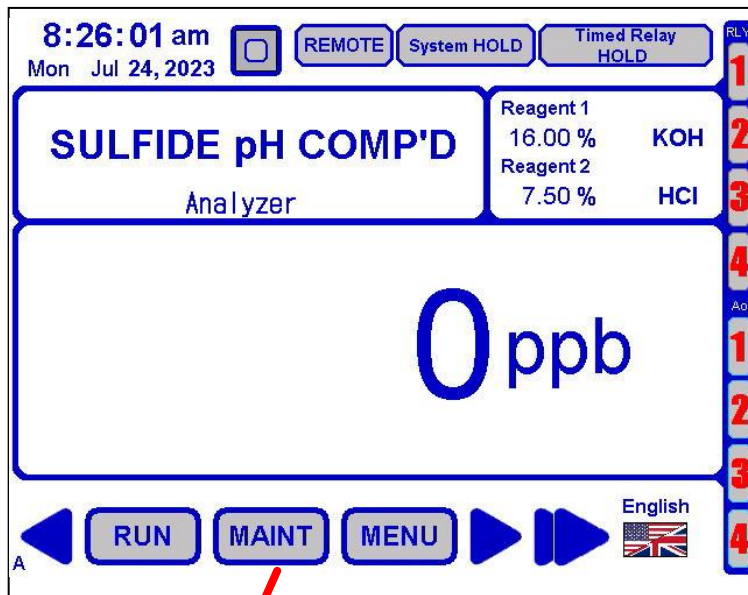

Choosing the function "DRAIN" will drain out the reaction cell and show this Warning screen.

7.5.3 MAINTENANCE MENU: STORE SENSOR

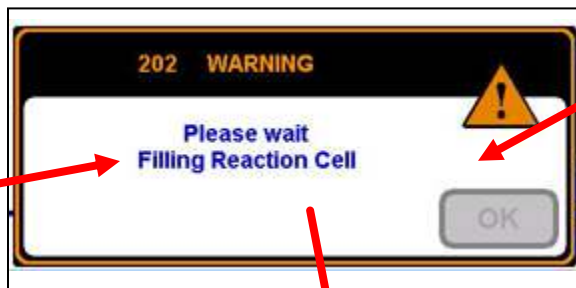
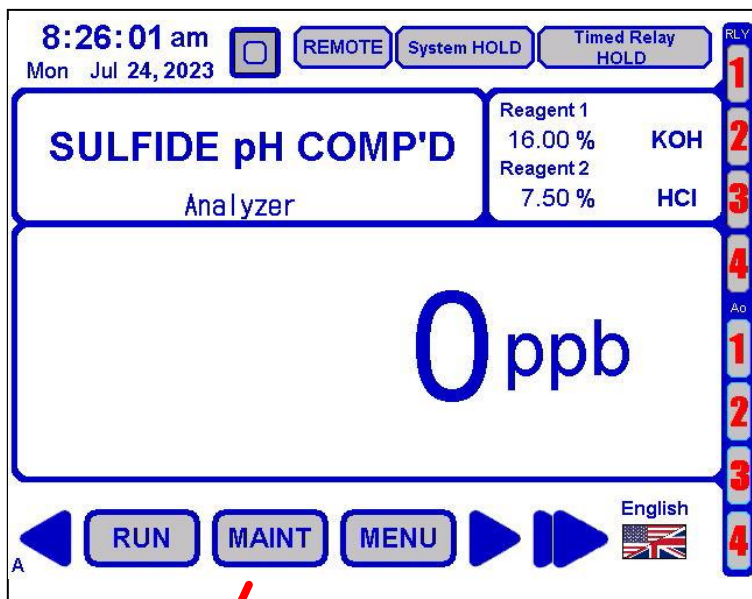

Choosing the function "STORE SENSOR" will fill up the reaction cell and show this Warning screen.

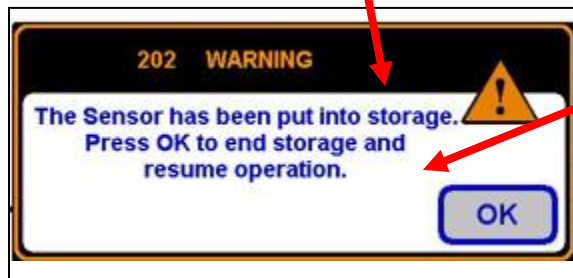

Once the cell is full, the following warning screen will appear.

To keep storage of sensor, leave this screen on.

To end storage, press "OK".



## 7.6 MENU FUNCTIONS (MENU HOME SCREEN)

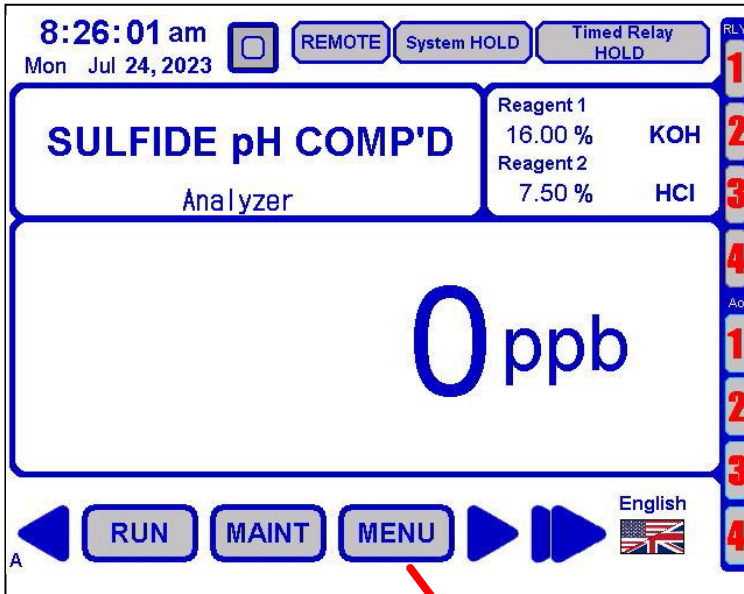

System Hold can be turned ON/OFF here.

Timeout for the Menu Home screen can be set here.

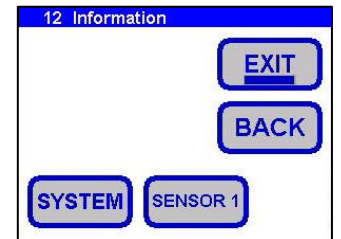
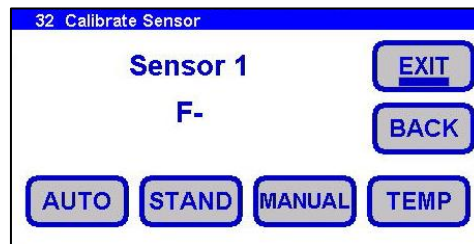
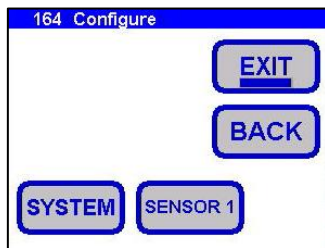
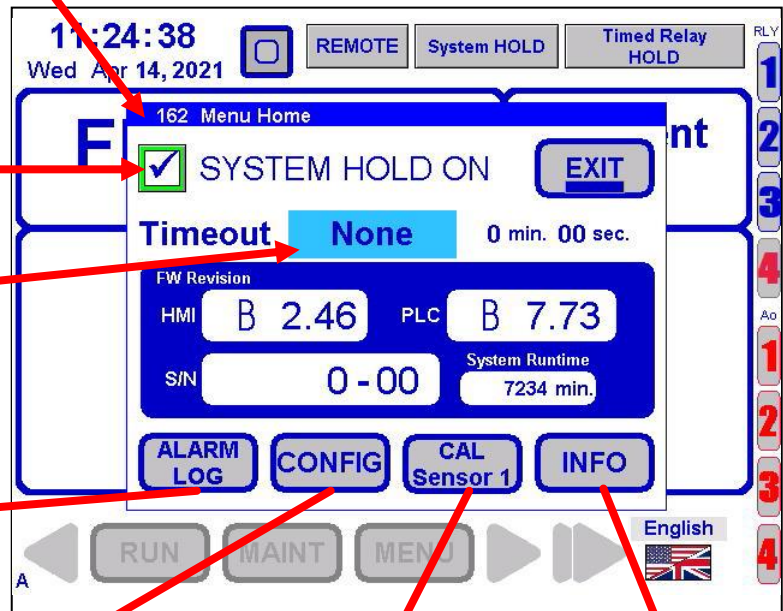

7.6.1 ALARM LOG

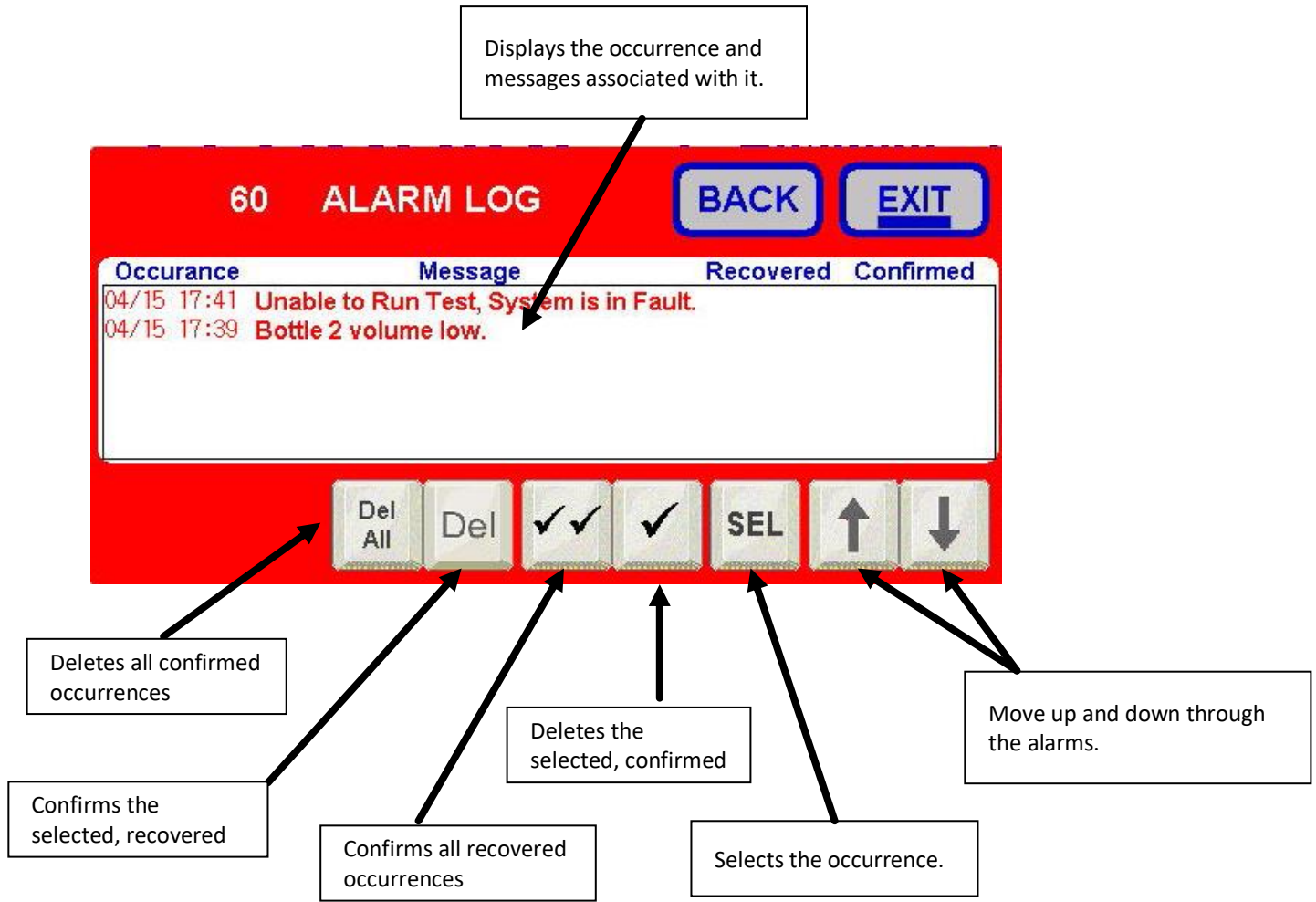

## 7.6.2 CONFIGURE

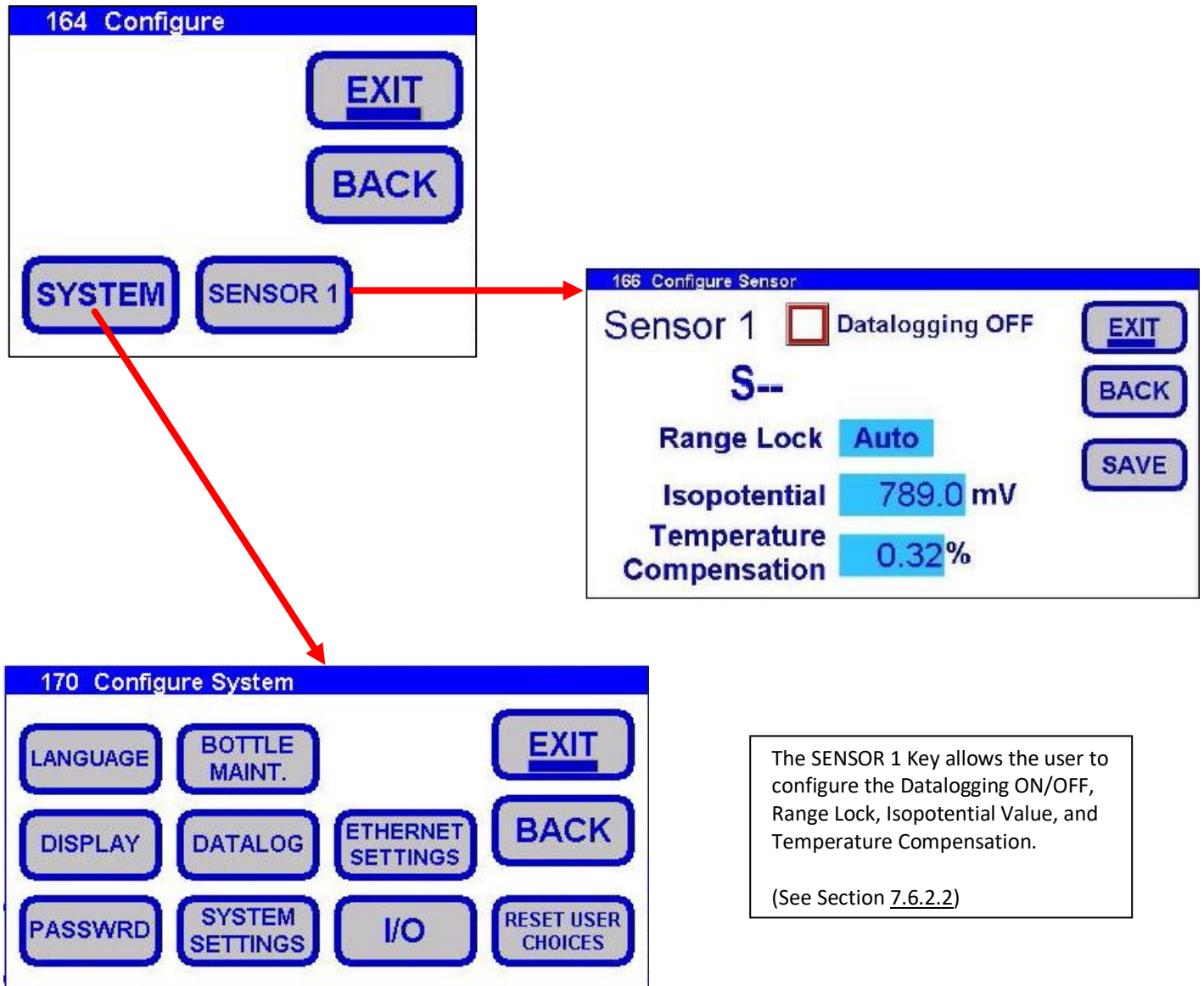

The SENSOR 1 Key allows the user to configure the Datalogging ON/OFF, Range Lock, Isopotential Value, and Temperature Compensation.

(See Section 7.6.2.2)

The SYSTEM Key allows the user to configure:

1. Language
2. Bottle Maintenance
3. Display
4. Datalog
5. Ethernet Settings
6. Password
7. System Settings
8. I/O
9. Reset User Choices

### 7.6.2.1 Configure (System Menu)

#### 7.6.2.1.1 Language

The user is able to choose between English and Spanish Language.

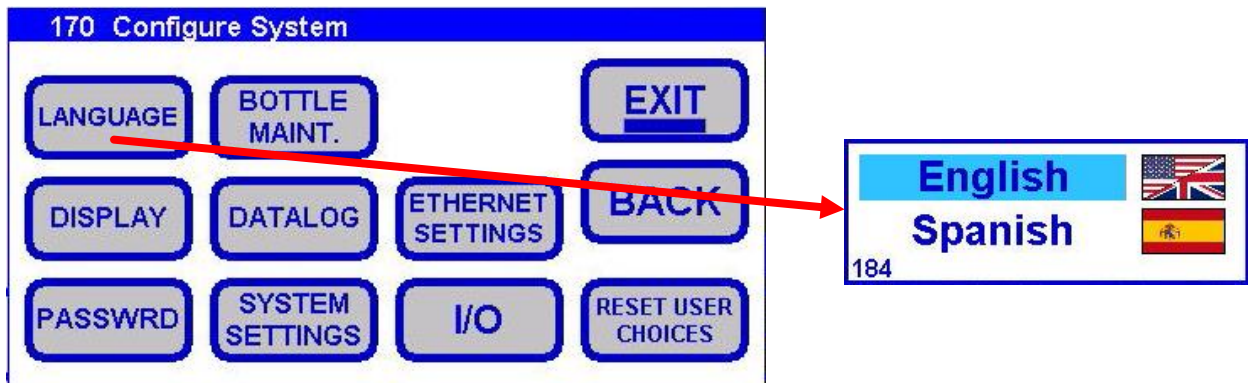

#### 7.6.2.1.2 Bottle Maintenance

The Bottle Maintenance Key allows the user to Name the Bottle, Input the Bottle Volume, and provide a Low Liquid Volume Alert Level.

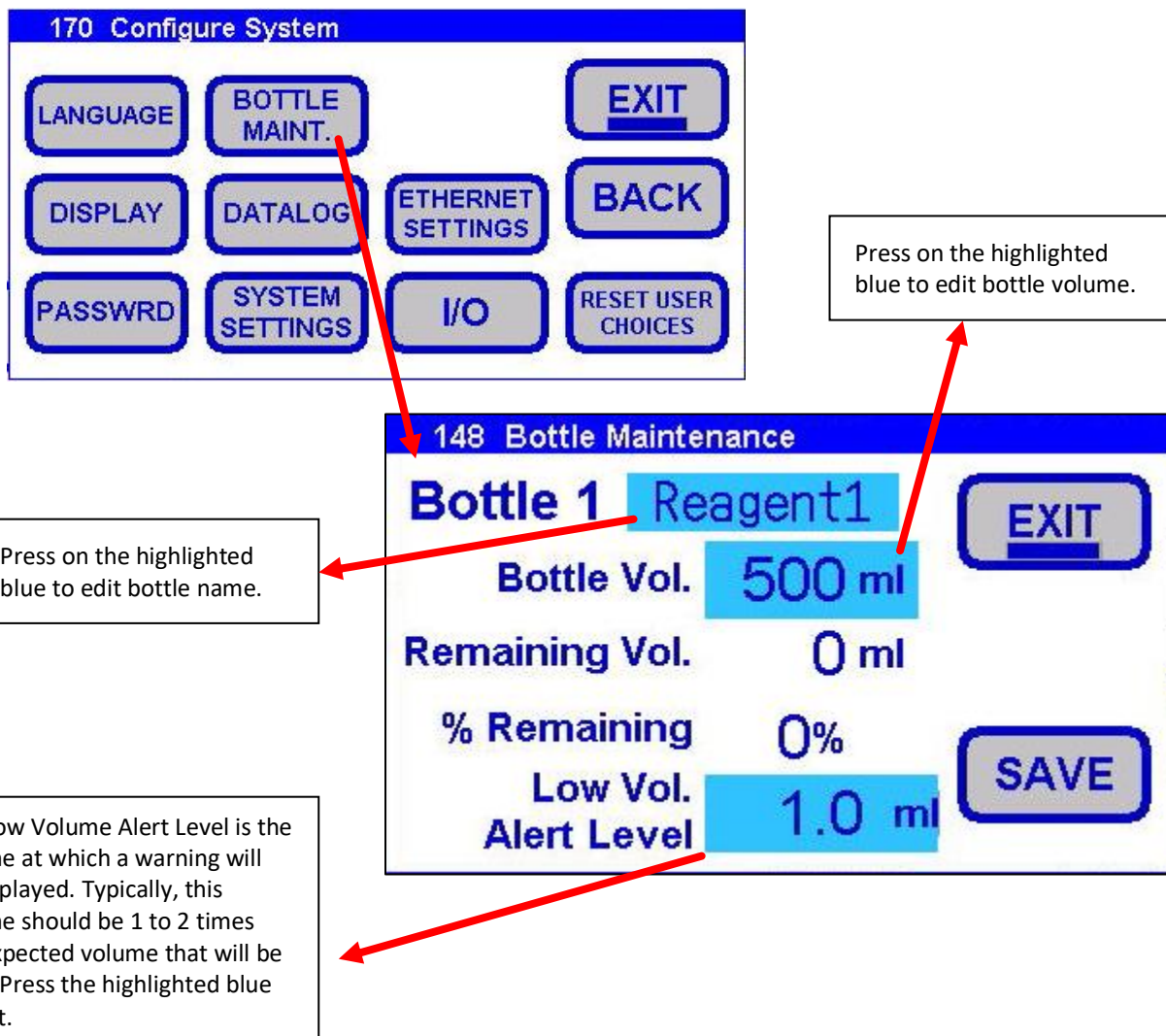

7.6.2.1.3 Display

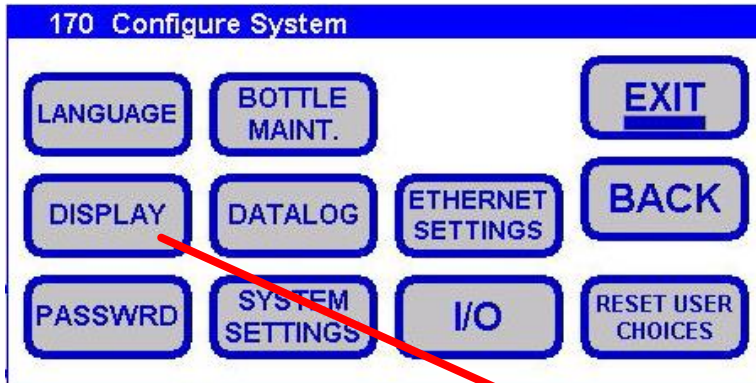

Pressing the square will turn ON/OFF the screen saver after the configured Timeout time.

The screen saver turns off the display backlight (dark screen) but the HMI's power LED is still on. Pressing anywhere in the display area will turn back on the backlight.

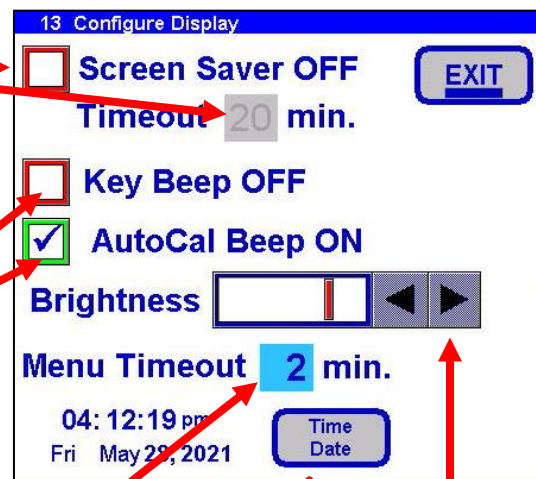

Beep ON will sound a "beep" each time a key is pressed.

Beep OFF will mute this sounds.

Key Beep ON sounds each time a key is pressed.

AutoCal Beep ON sounds each time the AutoCal occurs.

Adjust the Menu Timeout. After the configured time, the Menu will exit to a base screen.

Adjust the Display Intensity.

Pressing the checkbox will change the time format between 12 and 24 hour..

Pressing the checkbox will change the calendar format between MM/DD/YYYY and DD/MM/YYYY.

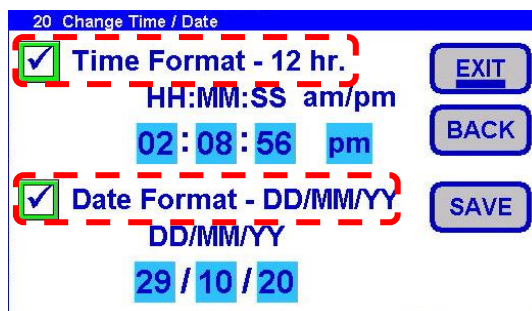

### 7.6.2.1.4 Datalog

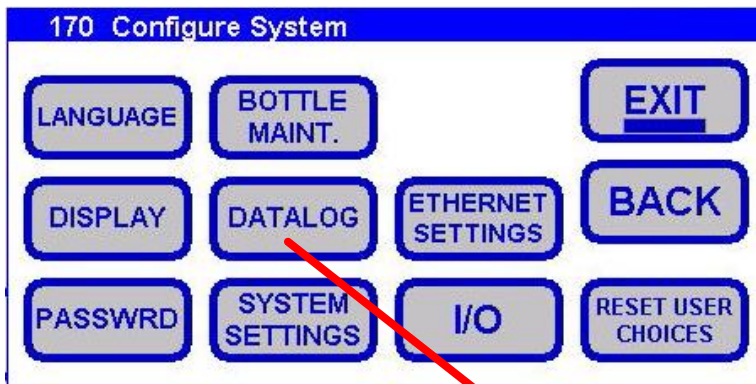

\* The USB stick will be damaged if not ejected properly. The user must EJECT (USB Eject) the USB stick before removal.

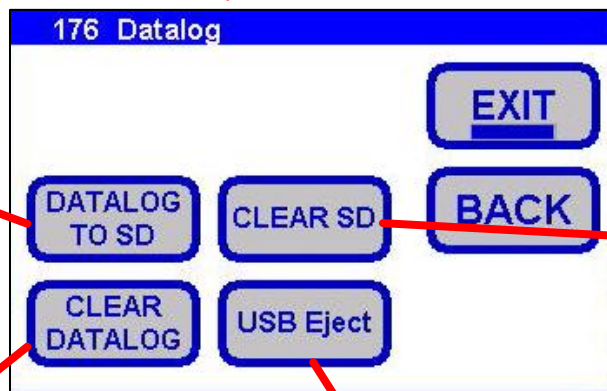

Forces the Datalog to be written to the SD now instead of waiting the real-time timeout

Clears the Alarm, Data and Event logs from the SD card

Clears the Data and Event logs from the system memory

Clears the Data Allows the USB memory stick to be eject from the system without harming any data on the stick

### 7.6.2.1.5 Ethernet Settings

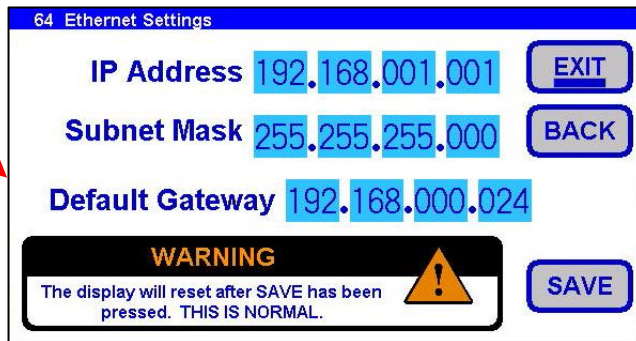
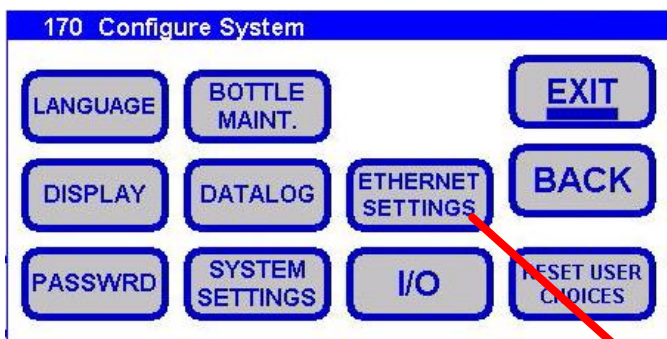

7.6.2.1.6 Password

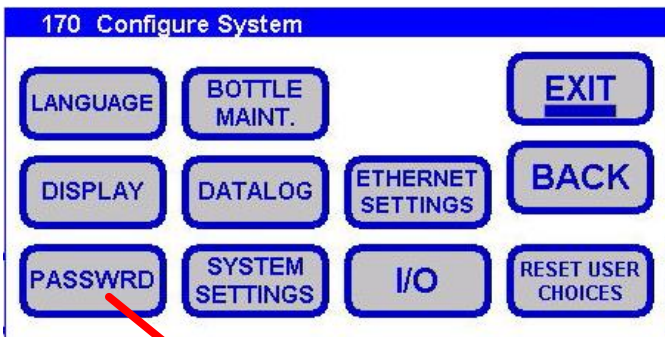

Pressing the red square (without checkmark) will turn on both the Calibration (green square with checkmark) and Configuration passwords. The gray square with checkmark denotes the Configuration password cannot be turned off.

Both passwords are the same by default but can be modified by the user.

The Configuration password can be turned on independent of the Calibration password.

The respective password will be active on the next entry into the Calibrate or Configure Screens.



7.6.2.1.7 System Settings

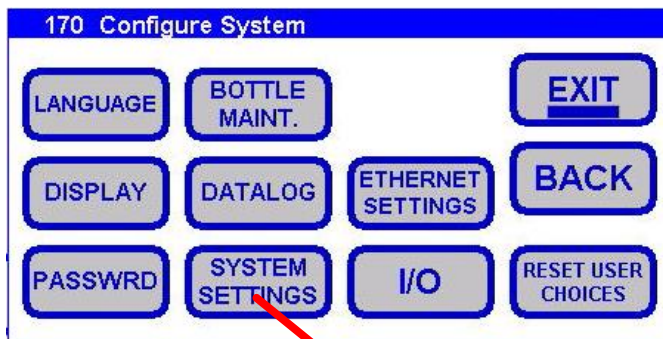

The system settings allows the user to input the Sample Fill Rate, Drain Rate and Reagent Fill Rate. These settings are configured at the ECD Factory and should only be changed by qualified personnel upon contact to ECD.

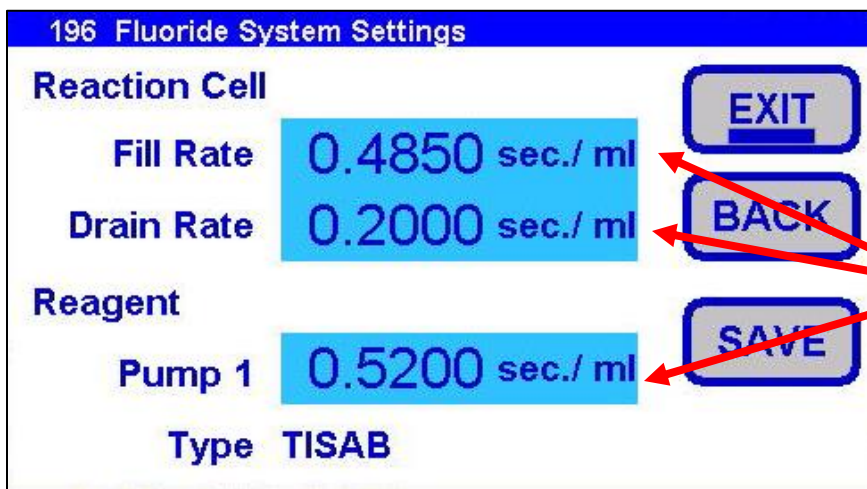
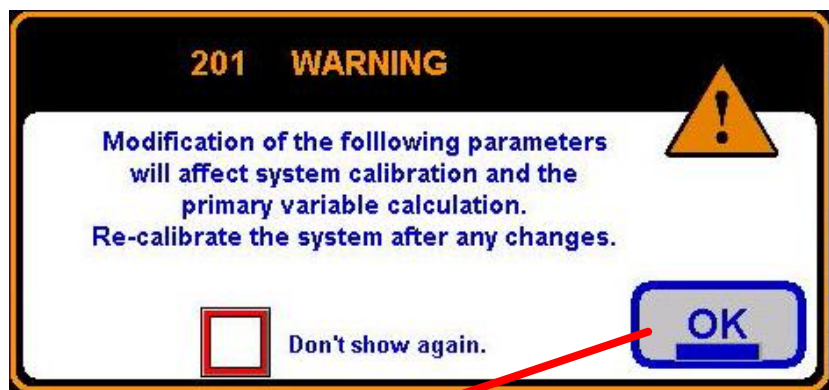

These values are configured and determined at ECD's Factory. Recalibration must be done if any adjustments are made here. Adjust the rate(s) and press SAVE.



### 7.6.2.1.8 I/O – Digital Inputs

Digital Inputs are simple switch inputs where the corresponding +24Vdc connector pin is shorted to the corresponding input connector pin indicating an external switch is ON and left open indicating OFF. Di devices can be used to monitor various switch devices. The Di device can be given a descriptive Name such as “Lo Vol” in order to facilitate reading the CA900 channel with the DI device. The Di device only has to be enabled for monitoring and to start datalogging, the Di device doesn't have to be displayed on Base Screen A for the input to be continually monitored

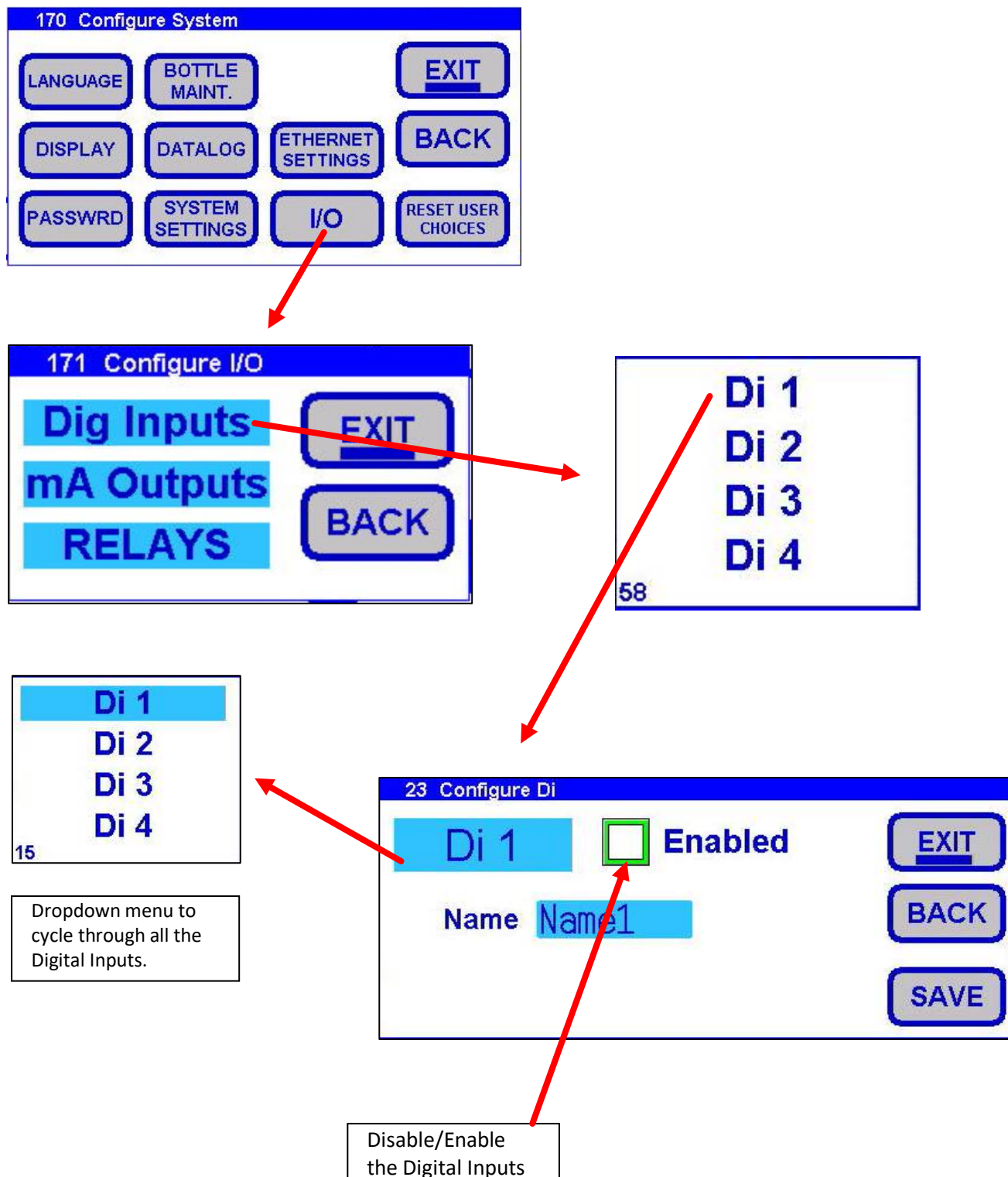

### 7.6.2.1.9 I/O – 4-20 mA and Relays

(See Section 7.7 for 4-20 mA and Section 7.8 for Relays)

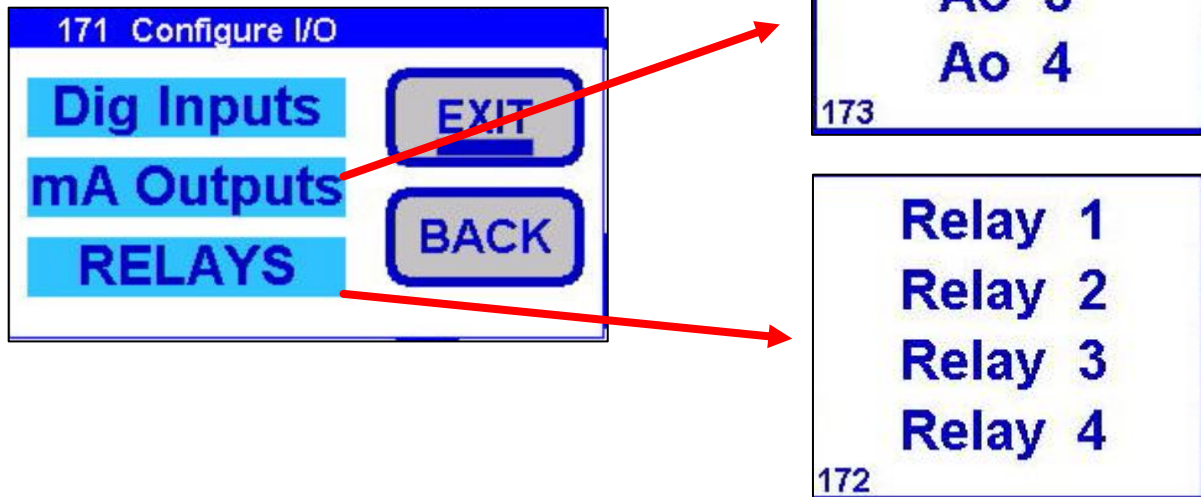

### 7.6.2.1.10 Reset User Choices

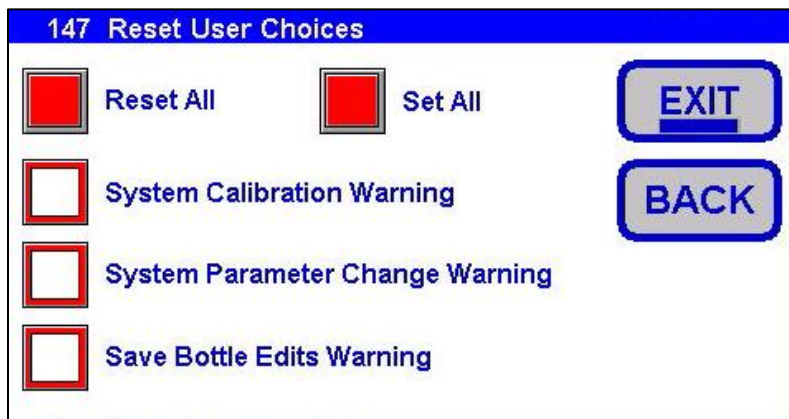
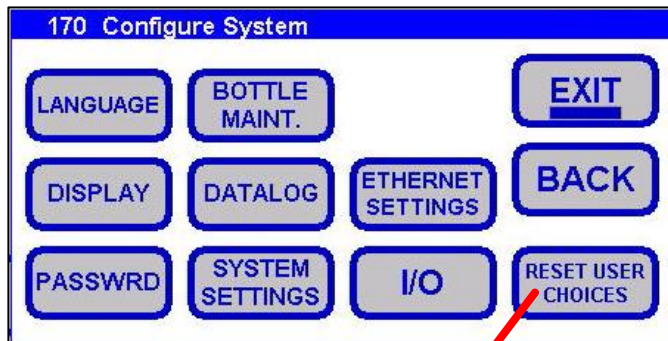

The reset user choices screen allows the user to set or reset previous choices made about viewing the warning screens again. The red square without check mark means the warning will be displayed, whereas, the green square with the check mark means the warning will not be displayed.

### 7.6.2.2 Configure (Sensor Menu)

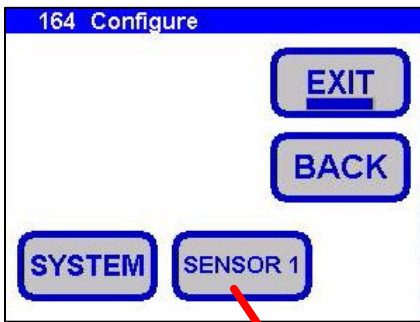

The unit range can be locked to only show ppb, ppm or automatically adjust between the two.

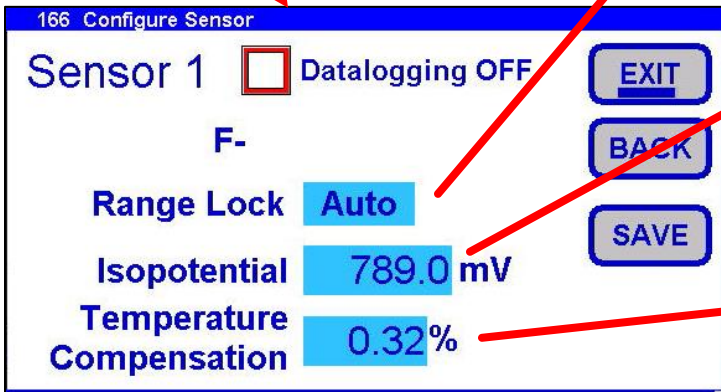

Each Sulfide electrode has a unique Isopotential determined at the factory. Please see the provided test report or contact ECD for this information.

A temperature compensation is established when an automatic calibration is conducted.

### 7.6.3 CAL SENSOR 1

CAL Sensor 1 allows the user to calibrate the Sulfide Sensor. Different types of calibrations are available such as automatic two point calibration, standardization, manual calibration. A temperature calibration is also found in this menu.

(See Section 7.9 For the Calibration Guide)

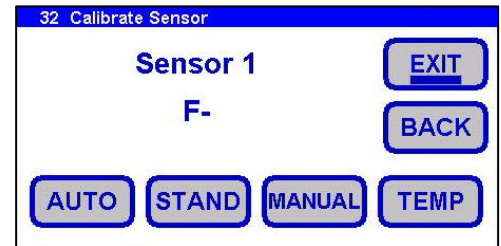
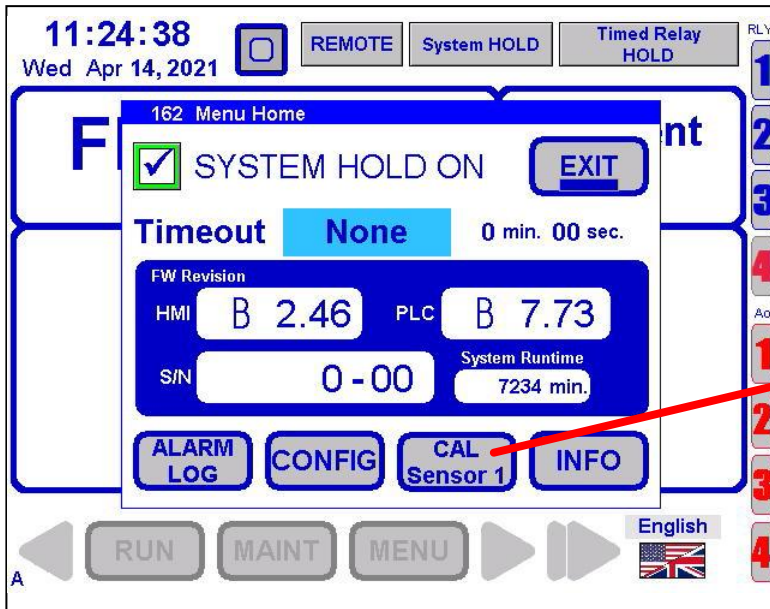

### 7.6.4 INFORMATION

The INFO (Information) menu allows the user to view the system and sensor information such as Ethernet, relay, 4-20 mA, and calibrations.

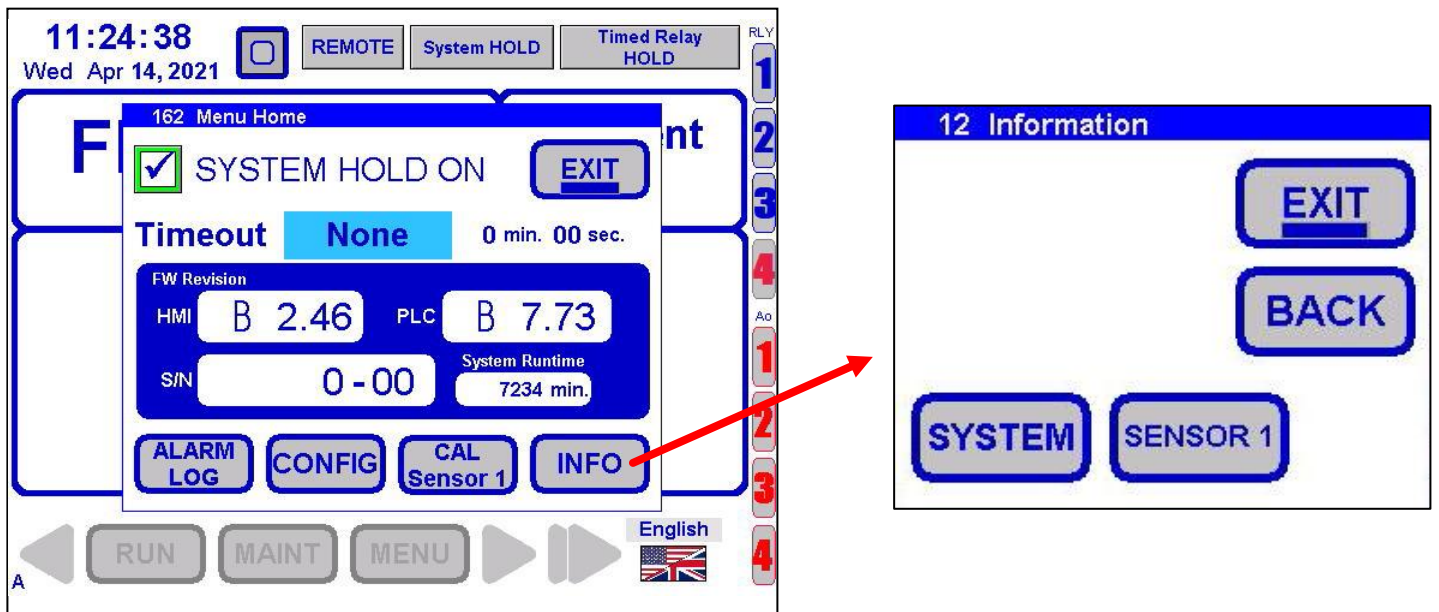

#### 7.6.4.1 Sensor Info

Sensor Information gives the user a single location to view data regarding the sensor. The first screen provides the serial number, revision, isopotential and temperature compensation of the sensor. The second screen shows the sensor range. There are three calibration logs with Cal Log 1 being the most recent. As calibrations are performed, the logs are shifted to next higher log number with the highest log number written over and lost. For example, Cal Log 1 becomes Cal Log 2, Cal Log 2 becomes Cal Log 3 and Cal Log 3 is lost. The current calibration is then stored in Cal Log 1.

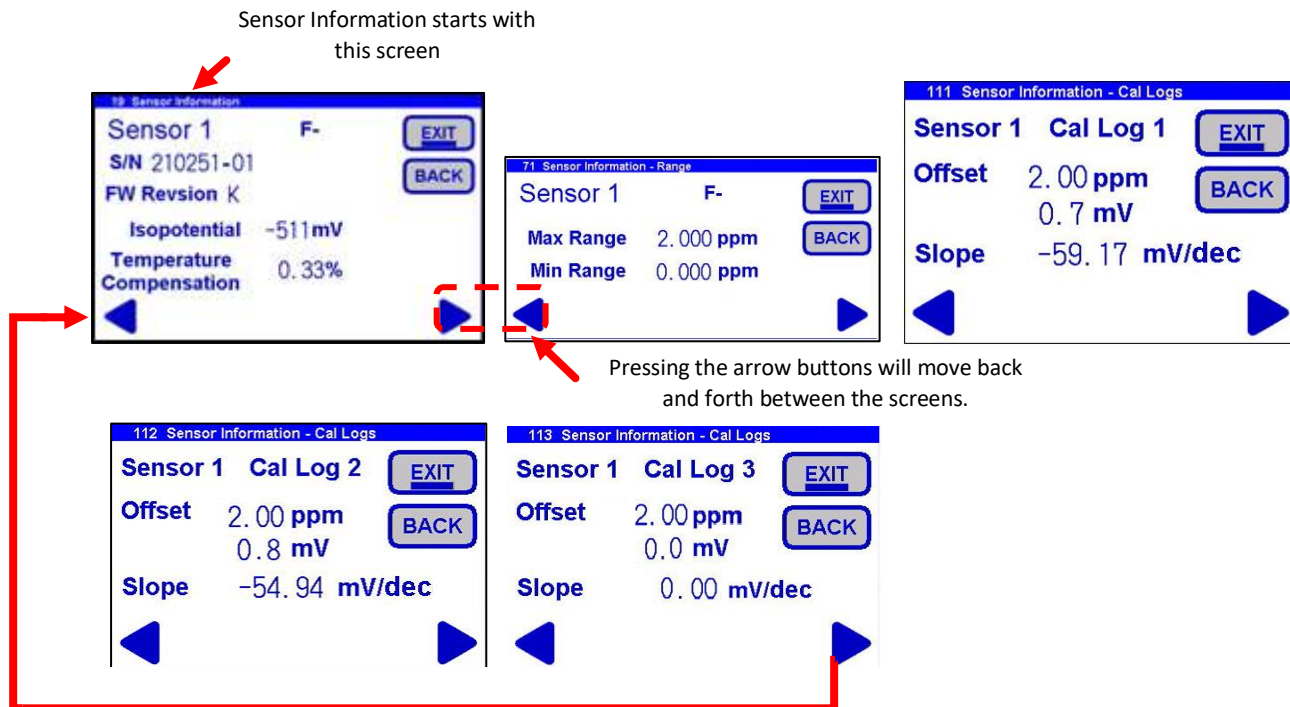

### 7.6.4.2 System Info

Pressing the SYSTEM button will present a series of Pulldown Screens containing information on various system parameters such as firmware revisions, system serial number, Ethernet addresses and mask, relay configurations and Ao configurations.

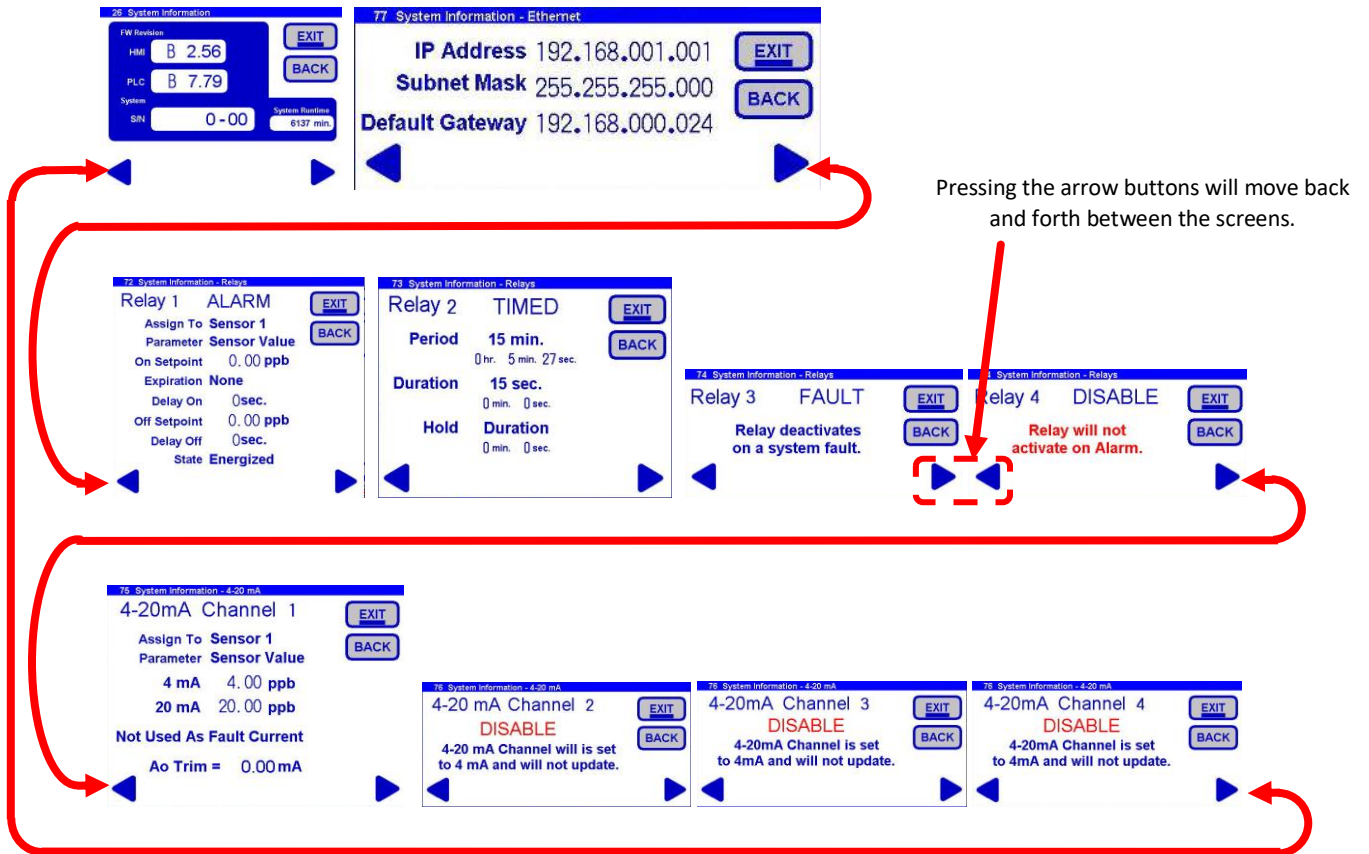

## 7.7 ANALOG OUTPUTS (4-20 mA) CONFIGURATIONS

Analog Outputs present proportional 4 to 20mA current output corresponding the signal level of any of the other CA900 devices (Sensors, Process Variable, Digital Inputs) assigned to the Ao channel. The 4 to 20mA output will correspond to the range starting and ending from the endpoints set by the user. For example, a sensor has a sensing range of 0 to 40,000ppm (40ppT), the user can choose to use an Ao to only monitor the sensing range from 500ppm (4mA) up to 1000ppm (20mA). A Name can be given to the Ao device in order to denote the meaning of the output. The Ao device only has to be enabled for monitoring and to start datalogging, the Ao device doesn't have to be displayed on Base Screen A for the input to be continually monitored.

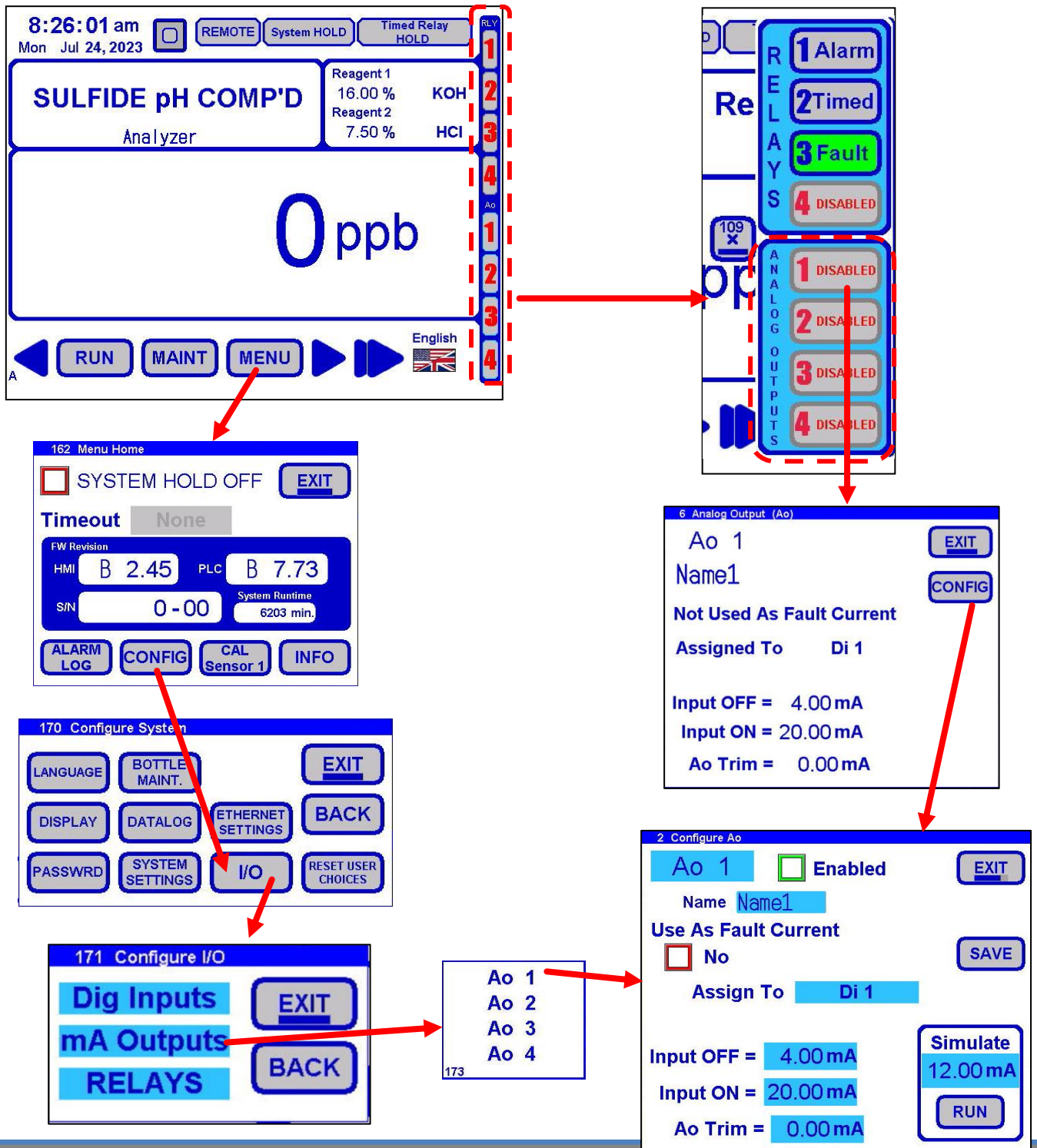

The 4-20 mA can be assigned to the Process Variable (PV), the Sulfide Sensor (Sensor 1 F-) or any of the Digital Inputs (Di 1-4)

The screenshot shows the '2 Configure Ao' dialog box. At the top, 'Ao 1' is selected and the 'Enabled' checkbox is checked. The 'Name' field contains 'Name1'. Under 'Use As Fault Current', the 'No' option is selected. The 'Assign To' dropdown is set to 'Di 1'. Below this, the 'Input OFF' is set to 4.00 mA, 'Input ON' is set to 20.00 mA, and 'Ao Trim' is set to 0.00 mA. A 'Simulate' section shows '12.00 mA' and a 'RUN' button. To the right, a separate box lists 'Sensor 1 F-', 'Sensor 2 --', 'PV', 'Di 1', 'Di 2', 'Di 3', and 'Di 4'. A red arrow points from 'Di 1' in the 'Assign To' field to 'Di 1' in the list box. The number '191' is visible at the bottom left of the list box.

### 7.7.1 4-20 MA (PROCESS VARIABLE, PV)

The screenshot shows the '2 Configure Ao' dialog box with 'Assign To' set to 'PV'. The '4 mA' field is set to 0.00 ppb, the '20 mA' field is set to 0.00 ppb, and 'Ao Trim' is set to 0.00 mA. The 'Simulate' section shows '12.00 mA' and a 'RUN' button. A red dashed box highlights the 4 mA, 20 mA, and Ao Trim fields. A red arrow points from the 'Simulate' section to a callout box that says: 'To Simulate the 4-20 mA, adjust here and choose "RUN".'. Another red arrow points from the dashed box to a callout box that says: 'Configure the 4 and 20 mA outputs here. The user is able to Trim the mA.'

### 7.7.2 4-20 mA (SENSOR VALUE)

Configure the 4-20 mA for the Sulfide Sensor's measurement. In the example, 0.00 ppT corresponds to 4.0 mA output and 2.000 ppT corresponds to 20.0 mA output.

The screenshot shows the '2 Configure Ao' dialog box. At the top, it says 'Ao 1' and 'Enabled' with a checked checkbox. There is an 'EXIT' button. Below that, the 'Name' field contains 'Name1'. The 'Use As Fault Current' section has an unchecked checkbox and the label 'No', with a 'SAVE' button. The 'Assign To' field is set to 'Sensor 1' with an 'F-' label. The 'Parameter' field is set to 'Sensor Value'. Below this, there are two rows for calibration: '4 mA =' followed by a text box containing '0.000' and 'ppT', and '20 mA =' followed by a text box containing '2.000' and 'ppT'. At the bottom left, 'Ao Trim =' is followed by a text box containing '0.00 mA'. On the right side, there is a 'Simulate' button with '12.00 mA' below it, and a 'RUN' button at the bottom.

### 7.7.3 4-20 mA (SENSOR TEMPERATURE)

Configure the 4-20 mA for the Sulfide Sensor's Temperature.

The screenshot shows the '2 Configure Ao' dialog box. At the top, it says 'Ao 1' and 'Enabled' with a checked checkbox. There is an 'EXIT' button. Below that, the 'Name' field contains 'Name1'. The 'Use As Fault Current' section has an unchecked checkbox and the label 'No', with a 'SAVE' button. The 'Assign To' field is set to 'Sensor 1' with an 'F-' label. The 'Parameter' field is set to 'Sensor Temp'. Below this, there are two rows for calibration: '4 mA =' followed by a text box containing '0.0' and '°C', and '20 mA =' followed by a text box containing '0.0' and '°C'. At the bottom left, 'Ao Trim =' is followed by a text box containing '0.00 mA'. On the right side, there is a 'Simulate' button with '12.00 mA' below it, and a 'RUN' button at the bottom.



### 7.7.4 4-20 mA (DIGITAL INPUT, DI 1-4)

Configure the 4-20 mA for the Digital Inputs 1-4. In the example, 4.00 mA turns OFF the input and 20.0 mA will turn ON the input.

The screenshot shows a configuration window titled "2 Configure Ao". It contains the following fields and controls:

- Ao 1**: A blue text field containing "Ao 1".
- Enabled**: A green checkbox that is currently unchecked.
- EXIT**: A button with a blue border and grey background.
- Name**: A blue text field containing "Name1".
- Use As Fault Current**: A label above a red checkbox that is currently unchecked.
- No**: A label next to the red checkbox.
- SAVE**: A button with a blue border and grey background.
- Assign To**: A label above a blue text field containing "Di 1".
- Input OFF =**: A label above a blue text field containing "4.00 mA".
- Input ON =**: A label above a blue text field containing "20.00 mA".
- Ao Trim =**: A label above a blue text field containing "0.00 mA".
- Simulate**: A button with a blue border and grey background, containing the text "Simulate".
- 12.00 mA**: A blue text field below the "Simulate" button.
- RUN**: A button with a blue border and grey background, located below the "Simulate" button.

## 7.8 RELAY CONFIGURATIONS

Any of the 4 relays can be configured as an Alarm, Timed or Fault Type and any relay can be Disabled and never used. The buttons down the right of Base Screen A will open configuration Pulldown Screens for the relay type assigned to the relay; in addition, the buttons also serve as indicators lighting up green when a relay has been activated and depict the Relay Type in plain text.

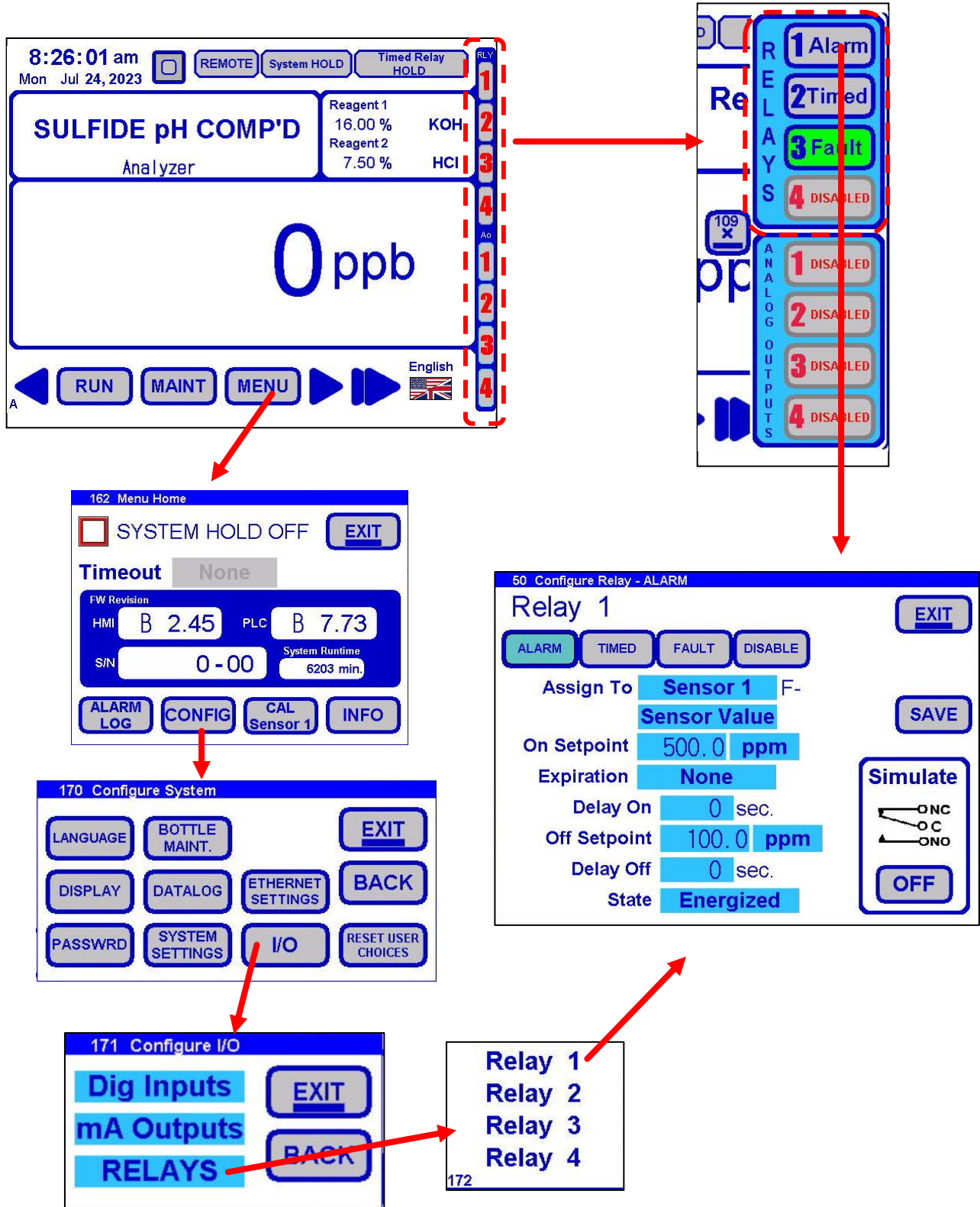

### 7.8.1 RELAY TYPE (ALARM)

Alarm type relays can be set to activate and deactivate at particular setpoints related to Sensor Readings or Temperature, Process Variable, or Digital Inputs. There are various options to enable different uses of the Alarm type relay.

Setting an expiration time for a relay allows for a level of fault detection in the relay circuitry, monitoring equipment and process control. Setting an expiration time will de-energize the relay and set an expired relay fault. A different relay set as a Fault Type can be used for an external problem notification.

The energized state means the normally open (NO) contact is open until the relay is activated, then the NO contact will close. Then De-Energized state means the NO contact is closed until the relay is activated, then NO contact will open.

Pressing any of the light blue area with numbers brings up the Numeric Keypad allowing number entry.

Pressing the light blue area brings up a Pull-down Screen allowing the user to set the parameter's scale. Some chemical types don't allow the span of ranges, ex. pH, in which case, the units wouldn't be highlight light blue.

Depending on the sensor, there will be different ranges presented with different Pull-down Screens.

### 7.8.1.1 Relay Type (Alarm – Sensor 1 Value)

The user can set an Alarm Relay for the Sensor 1 Value. Configure the “On Setpoint” and “Off Setpoint” to determine when the alarm will turn ON/OFF.

The screenshot shows the configuration screen for Relay 1. At the top, it says "50 Configure Relay - ALARM" and "Relay 1". There are four tabs: "ALARM" (selected), "TIMED", "FAULT", and "DISABLE". A "SAVE" button is on the right. Below the tabs, the configuration is as follows:

Assigned To	Sensor 1
Parameter	Sensor Value
On Setpoint	100.0 ppm
Expiration	None
Delay On	0 sec.
Off Setpoint	5.0 ppm
Delay Off	0 sec.
State	Energized

On the right side, there is a "Simulate" section with a diagram of a relay switch and an "OFF" button.

### 7.8.1.2 Relay Type (Alarm – Sensor 1 Temperature)

The user can set an Alarm Relay for the Sensor 1 Temperature. The maximum and minimum values are + 70°C and - 20°C respectively.

The screenshot shows the configuration screen for Relay 1. At the top, it says "50 Configure Relay - ALARM" and "Relay 1". There are four tabs: "ALARM" (selected), "TIMED", "FAULT", and "DISABLE". A "SAVE" button is on the right. Below the tabs, the configuration is as follows:

Assigned To	Sensor 1
Parameter	Sensor Temp
On Setpoint	0°C
Expiration	None
Delay On	0 sec.
Off Setpoint	0°C
Delay Off	0 sec.
State	Energized

On the right side, there is a "Simulate" section with a diagram of a relay switch and an "OFF" button.

### 7.8.1.3 Relay Type (Alarm – Process Variable)

The user can set an Alarm Relay for the Process Variable. The Process Variable represents the output after a full analysis cycle is completed.

The screenshot shows the configuration screen for Relay 1. At the top, it says "50 Configure Relay - ALARM" and "Relay 1". There are four tabs: "ALARM" (selected), "TIMED", "FAULT", and "DISABLE". A "SAVE" button is on the right. Below the tabs, the configuration is as follows:

Assign To	PV
On Setpoint	100.00 ppm
Expiration	None
Delay On	0 sec.
Off Setpoint	25.00 ppm
Delay Off	0 sec.
State	Energized

On the right side, there is a "Simulate" section with a diagram of a relay switch and an "OFF" button.

### 7.8.1.4 Relay Type (Alarm – Digital Input)

The user can set an Alarm Relay for any of the 1-4 Digital Inputs.

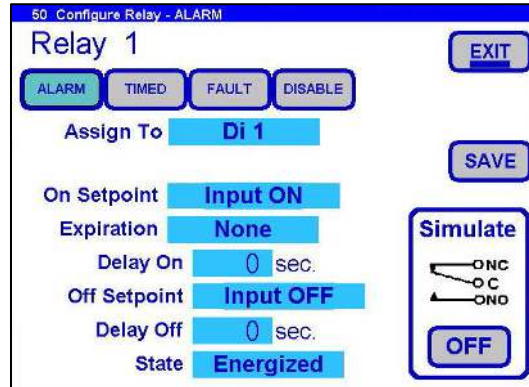

### 7.8.2 RELAY TYPE (TIMED)

Timed Type relays allow for a periodic activation independent of any CA900 device set points. This feature is especially useful for spray cleaners such as the ECD AC10. The timed relay can be set to activate the spray cleaner at a running period and for a duration of sparging. Since the sensor reading would be erratic due to the sparging, a hold can be set to avoid inadvertent relay activations and Ao outputs. The numbers under each of the parameters are the times remaining for the time set point.

15 min.  
30 min.  
1 hr.  
2 hr.  
4 hr.  
8 hr.  
24 hr.

39

The period is the time between the relay activations.

15 sec.  
30 sec.  
1 min.  
2 min.  
5 min.  
15 min.  
30 min.

40

The duration is the amount of time the relay is activated. The duration time begins at the start of the timed period.

OFF  
Duration  
+15 sec.  
+30 sec.  
+1 min.  
+2 min.  
+5 min.  
+15 min.  
+30 min.

41

A hold can be activated where all sensors are not monitored in order to stop inadvertent relay activations and Ao outputs. Hold times can be set to length of the timed duration or time intervals in addition to the timed duration.

Pressing this button will re-start all Timed Type relays synchronizing the start of each relay's period. The same result occurs when the power is cycled.

### 7.8.3 RELAY TYPE (FAULT)

Selecting a Fault Type will automatically activate the relay (the normally open, NO, contact closes) until a fault occurs, after which, the relay will be deactivated (NO contact opens). The Fault Type operates this way as a fail-safe notification of the CA900 loss of power where the Fault Type relay will open due to loss of power.

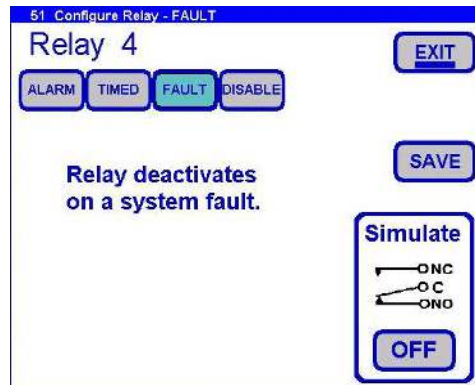

### 7.8.4 RELAY TYPE (DISABLE)

Relays can be disabled when not in use or when diagnosing a problem where relay activation is undesired. Disable the relay in question and later set the relay back to the type previously configured. All the setpoints and other parameters will have been saved and reconfigured into the relay.

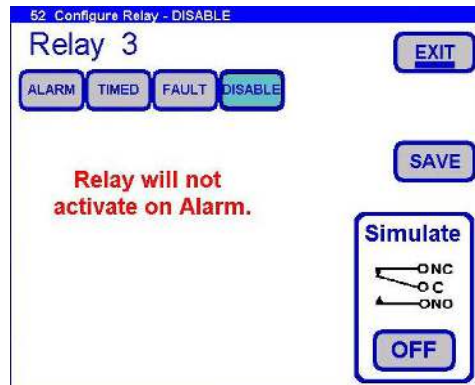

### 7.8.5 RELAY TYPE (SIMULATION)

Relay Simulation allows at-will testing of relay connections independent of the relay configuration. Exiting the relay configuration will return the relay to its previous activation state.

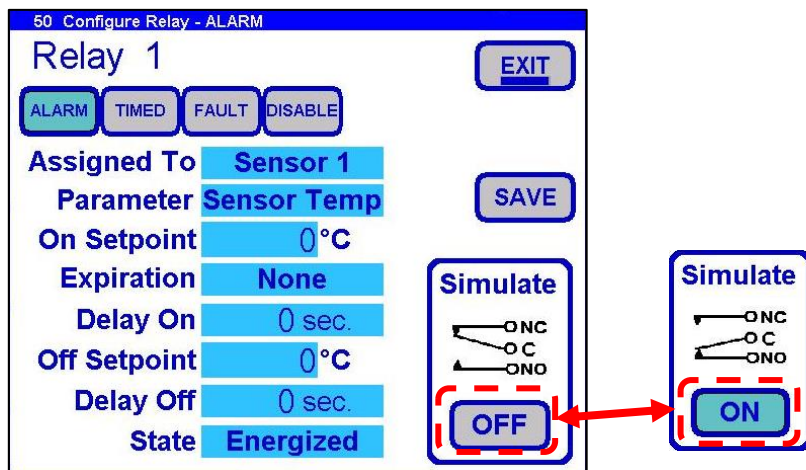

## 7.9 CALIBRATION

Sensor Calibration allows the user to adjust the sensor to known values in order to compensate for wear and tear on the electrode. There are four types of calibration; AUTO, STAND, MANUAL and TEMP each of which are described in separate sections below.

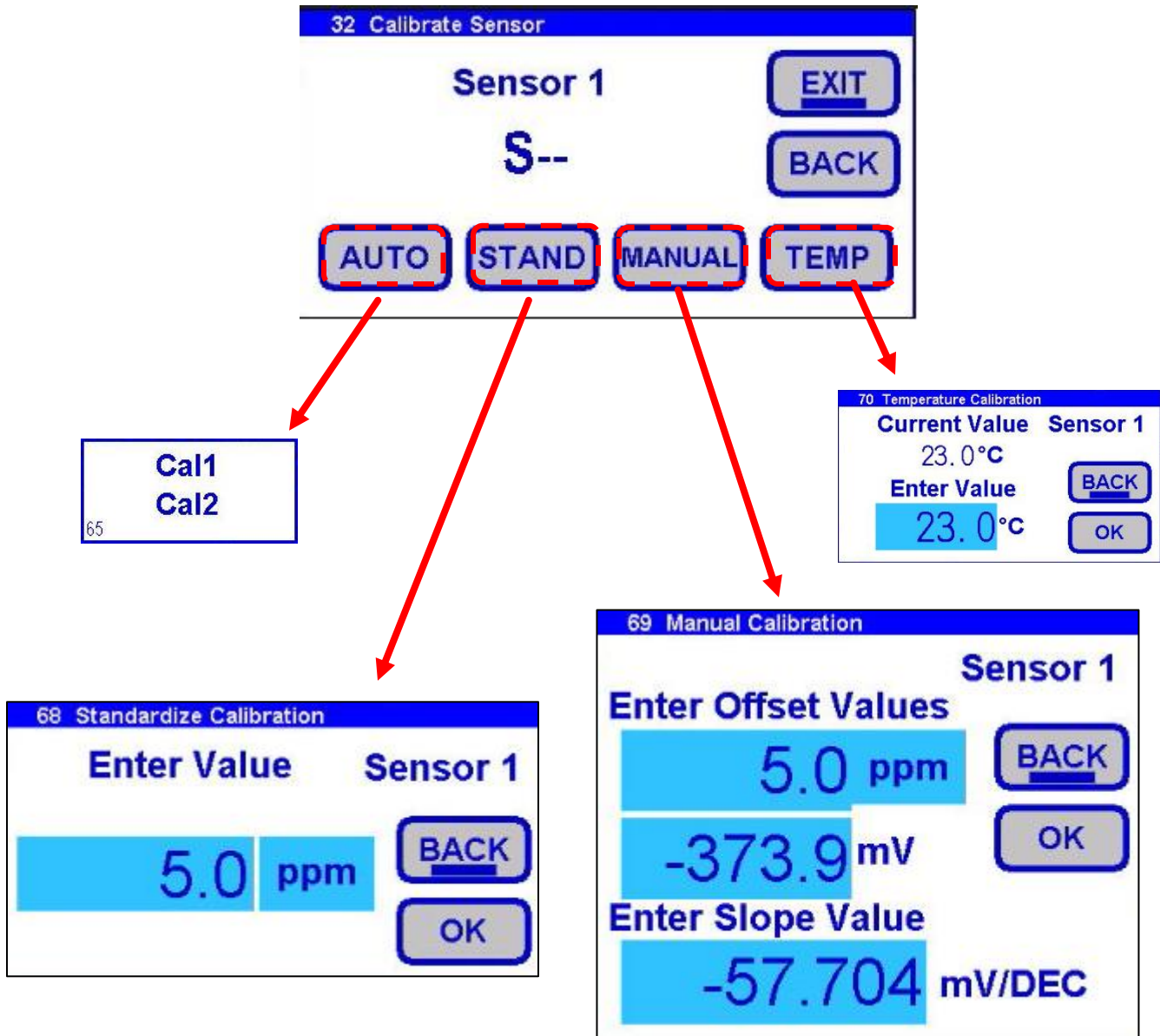

### 7.9.1 AUTO CALIBRATION AUTO

Auto Calibration is the primary calibration method for all measurements. Auto Calibration automatically recognizes the calibration solution the sensor is in and proposes the actual temperature compensated value for acceptance.

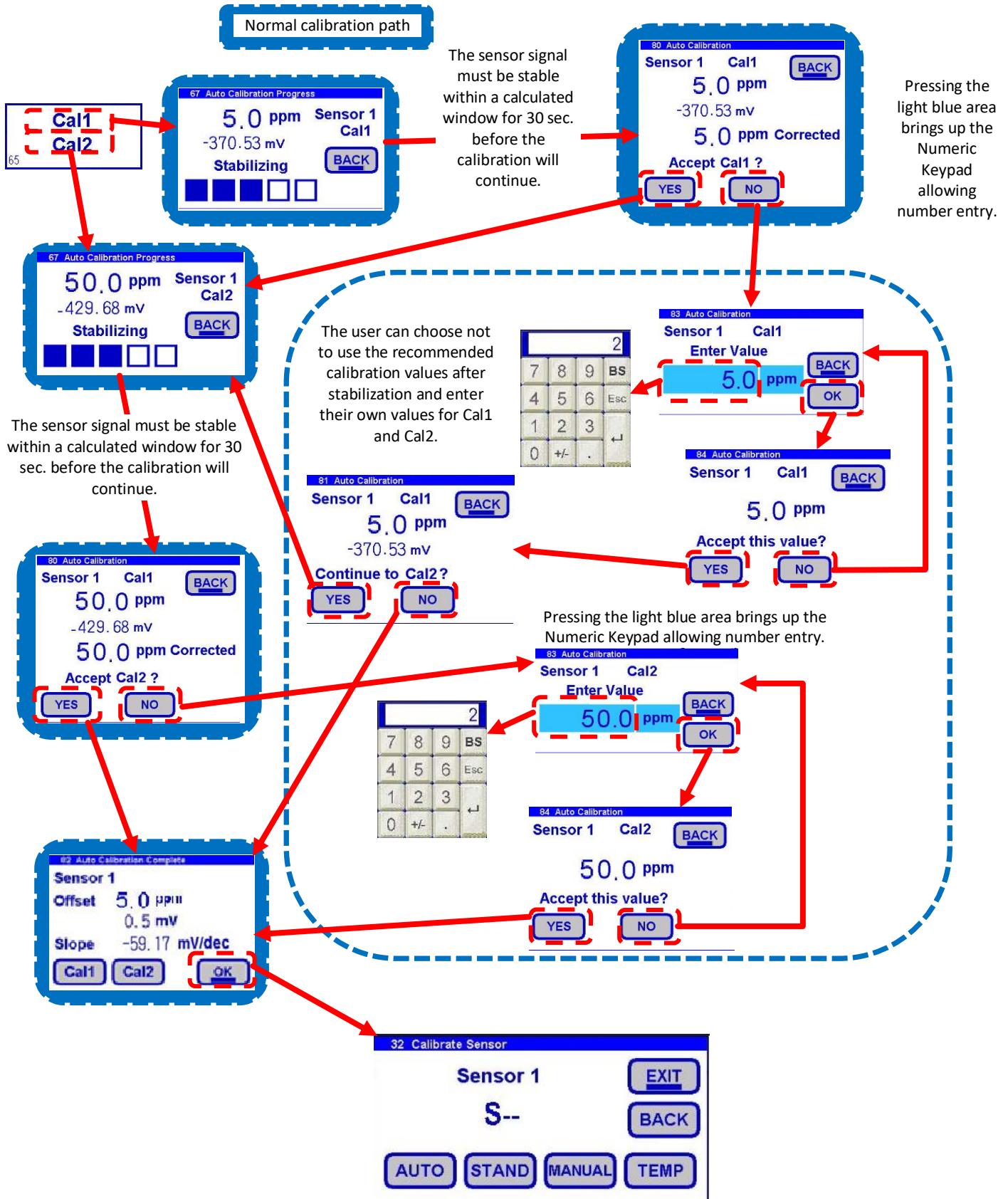



### 7.9.2 STANDARDIZE CALIBRATION STAND

A Standardize Calibration is a single point calibration where the sensor's reading is adjusted to agree with a solution of known value, either a calibration standard, a grab sample or laboratory determined value.

The diagram illustrates the Standardize Calibration process. It starts with a numeric keypad on the left showing the number '2' entered. A red dashed box highlights the '5.0 ppm' value on the 'Enter Value' screen for 'Sensor 1'. A text box explains: 'Pressing the light blue area brings up the Numeric Keypad allowing number entry.' The process continues through several screens: 'Enter Value' showing '315.95 ppm', a unit selection screen with options like 'ppb', 'ppm', and 'ppT', and a final unit selection screen with options like 'mVa', 'µg/L', 'mg/L', and 'µS'. A text box notes: 'Depending on the sensor, there will be different ranges presented with different Pulldown Screens.'

### 7.9.3 MANUAL CALIBRATION MANUAL

Manual Calibration allows the user to enter calibration data for an electrode into the transmitter without performing a calibration. A Manual Calibration requires entry of three pieces of data, (1) A concentration with the (2) corresponding mV value and (3) a slope for the electrode. These values are derived when the electrodes are manufactured and have been entered into the sensor before shipment. There is a test sheet for the electrode that includes the above values.

The diagram illustrates the Manual Calibration process. It starts with a numeric keypad on the left showing the number '2' entered. A red dashed box highlights the '5.0 ppm' value for '(1) Enter Offset Values'. Another red dashed box highlights the '373.9 mV' value for '(2) Enter Slope Value'. A third red dashed box highlights the '-57.704 mV/DEC' value for '(3) Enter Slope Value'. A text box explains: 'Pressing the light blue area brings up the Numeric Keypad allowing number entry.' The process continues through several screens: 'Enter Offset Values' showing '0 ppm', 'Enter Slope Value' showing '0.0 mV', and a final unit selection screen with options like 'ppb', 'ppm', and 'ppT'. A text box notes: 'Depending on the sensor, there will be different ranges presented with different Pulldown Screens.'

### 7.9.4 TEMPERATURE CALIBRATION TEMP

Temperature Calibration allows the user to correct the sensor's temperature to the process temperature.

The diagram illustrates the Temperature Calibration process. It shows a numeric keypad on the left with the number '2' entered. A red dashed box highlights the '23.0°C' value on the 'Enter Value' screen for 'Sensor 1'. A text box explains: 'Pressing the light blue area brings up the Numeric Keypad allowing number entry.' The screen also shows 'Current Value' as '23.0°C' and 'Enter Value' as '23.0°C'.

# 7.10 MENU AND USER INTERFACE CONFIGURATIONS

## 7.10.1 SYSTEM HOLD INDICATIONS

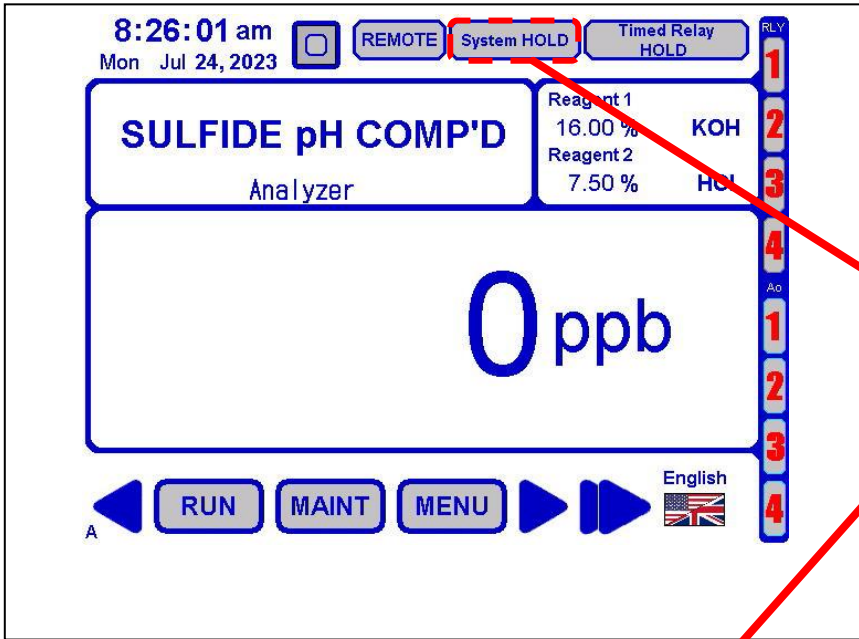

There is no BACK button on Popup Screen 10, Menu Home, as this screen is the start of the menu structure and BACK would be the same as EXIT.

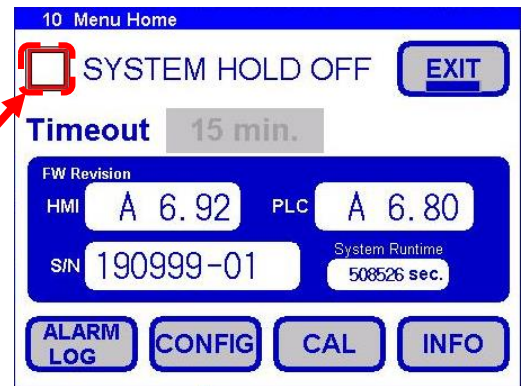

Pressing the Checkmark Box turns on or off System Hold.

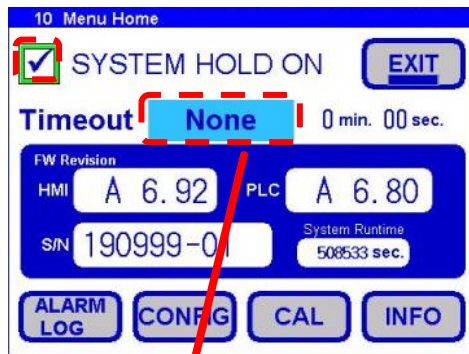

Pressing the light blue area allows System Hold Timeout to be selected.



The light blue area indicates the current selection. Press any list item for that selection.



## 8.0 MAINTENANCE

Basic maintenance on the CA900 Sulfide Analyzer requires refilling or replacing reagent containers and cleaning the Reaction Cell on a regular basis. In addition, it is advised to perform an overall visual check of the wetted parts for any leakage. If any leaks are detected, take immediate corrective action. Cleaning of the analyzer cabinet is best performed using a soft, non-aggressive cleaner. The use of a logbook for registering reagent refiling, corrective measures and performed scheduled maintenance is strongly recommended.

Switch off the power to the analyzer prior to the performance of the basic maintenance work, the CA900 Sulfide Analyzer cannot be operational during maintenance. Prior to any maintenance work, take into consideration all necessary precautions regarding personal safety (protective clothing, safety glasses etc). Always label and rinse all connected tubing with water prior to removal of analyzer.

	<p><b>Caution</b></p> <p>The CA900 Sulfide Analyzer uses a chemical reagent.</p> <p>Make sure that proper safety precautions are taken (e.g. using safety gloves and glasses) when handling chemical reagents.</p>
---	--

### 8.1 VISUAL CHECK

Visually check the following items whenever possible:

- Liquid leakage
- Cell sample level (during cycle)
- Electrode Sensor and Reaction cell cleanliness and condition
- Reagent levels

### 8.2 MONTHLY

- Visual check (as stated above)
- Replace Drain Pinch Valve Tubing
- Clean the Reaction Cell
- Replace Reagent 1, 2 and reset reagent counter
- Standardization (1 point Adjustment)
- Recalibration if needed.

### 8.3 EVERY 4-6 MONTHS (DEPENDING ON APPLICATION)

- Replace Hydraulic Tubing
  - Peristaltic Pump Sample Tubing
  - Peristaltic Reagent Tubing
  - Sample Tubing
- Clean/Replace Fittings
- Recalibration (if not performed on a monthly basis)

### 8.4 ANNUAL

- Replace Sulfide Electrode (depending on application the electrode may need replacement every 6 – 12 months)
- Analyzer general inspection (for qualified personnel only)

## 9.0 TROUBLESHOOTING

Symptom	Probable cause	Remedy
Blank Display	No Power	Check power source, 110/220VAC
Incorrect readings	Sensor needs calibration	Perform a standardization calibration. See INFO for calibration log
	Incorrect Temperature measurement	Calibrate/Trim Temperature to correct value
	Temperature Compensation set up incorrectly	Verify: 0.33%
“Sensor Comm Lost” prompt	Lost connection between sensor and controller	Check sensor connection to controller, loose connector? Visually inspect cable for cuts or crushed areas, replace sensor if cable is compromised

## 10.0 SENSOR MAINTENANCE

The Sulfide sensor requires periodic cleaning and/or replacement. The life of an electrode is dependent on the process conditions it is exposed to. The chemical constituents in the process may coat the electrode surfaces requiring the electrode to be removed and cleaned or replaced. Cleaning agents should be specific to the type of coating, detergents, and alcohols for removing greases and oils, acids for removing hard water scales and metallic deposits or spray washing for flocculants and biofilms.

### 10.1 ELECTRODE CARTRIDGE REPLACEMENT

Periodic replacement of the electrode cartridges is required for the CA900 Sulfide Analyzer. The following procedure explains how to replace the electrode cartridge in the sensor assembly:

1. Remove the sensor assembly from the reaction cell, rinse with tap water and wipe the sensor body dry.
2. Remove the electrode cartridge from the front of the sensor assembly by turning it counterclockwise.
3. Take the new electrode cartridge and remove the protective soaker boot and element cover. *Be careful not to flex the electrode body while removing the tape and the protective boot.*
4. Rinse the electrode tip in tap water, and wipe the electrode body dry, then lubricate the o-ring seals with the included lubricant. *Save the protective soaker boot in the event the electrode must be stored at a future time.*
5. Replace the electrode cartridge by inserting the BNC connector (silver cylinder) into the open end of the sensor body pushing past the first o-ring, up to the second o-ring where the electrode cannot be pushed further. Continue the installation by turning the electrode clockwise into the sensor body (screwing the electrode into the sensor body) past the second o-ring on the electrode stopping at the last ridge on the electrode body. Turning the electrode should stop, as the electrode is completely seated.

**NOTE: DO NOT OVER-TIGHTEN THE ELECTRODE. IF EXCESS FORCE IS REQUIRED DURING ELECTRODE INSTALLATION, CHECK FOR PROPER THREAD ENGAGEMENT OR FOR AN OBSTRUCTION.**

### 10.2 ELECTRODE CARTRIDGE MAINTENANCE

An important aspect of sensor maintenance is the service of the electrode cartridge. After being in operation, an electrode may begin to exhibit slow response or non-reproducible measurement. This may be due to coating of the measurement electrode or clogging of the reference junction. Regular electrode cleaning reduces problems associated with the coating and clogging. Frequency of cleaning will depend on the process and application.

If possible, the electrode can be cleaned without removing it from the sensor body. However, if the electrode must be removed, the o-rings must be inspected and re-lubricated with the silicone grease supplied with the CA900 Sulfide Analyzer.

#### 10.2.1 CLEANING

The Sulfide solid state crystal based electrode is fairly robust and can be cleaned with alcohols, detergents, or dilute acids to remove coatings caused by greases, oils, or films. A soft tooth brush or paper towel should be used to remove stubborn coatings, but the sensor tip should be avoided. Do not clean with a wire brush. Metal carry-over from the brush will compromise the measurement. Cleaning should be followed by polishing before calibrating the sensor.

## 10.3 S80/DS80 SENSOR SPECIFICATIONS

1. Dimensions: DS80/S80 – ¾" OD x 8" Length
2. Cable Length: 4' standard 4 conductor shielded
3. Housing Materials: 316 Stainless Steel
4. Ring Materials: Standard: Viton™ (VIT)
5. Shipping Weight: S80/DS80 1.2kg (2.5lbs.)

### 10.3.1 SULFIDE ELECTRODE

Part#:	2005163.VIT
ISE sensor:	solid state LaF crystal
Construction:	PEEK body
Reference Electrode:	double porous Teflon junction
Measurement range:	0.02 – 32,000 ppm
pH Range:	11 – 14 pH w/pH comp. 13 without pH comp.
Temperature Range:	0° – 80°C
Pressure Range:	50 psig

## 11.0 ANALYZER SHUTDOWN

If the CA900 Sulfide Analyzer will be out of service for a period of two weeks or greater, proceed as follows:

1. Empty all reagent containers.
2. Rinse and refill all reagent containers with distilled water.
3. Prime all of the pumps with DI water.
4. Disconnect the sample feed line and fill the fast-loop reservoir (if present) with distilled water.
5. With the sample inlet tubing attached to a container of distilled water, run the analyzer for at least 2 cycles.
6. Empty the water from all lines.
7. Put the analyzer in stand-by condition.
8. Turn OFF the power to the analyzer and disconnect the plug from the wall socket.
9. Place the Sulfide electrode sensing element orange cap over the sensing element.
10. Place the Sulfide sensor electrode (sensing end) into booting solution (clear rubber cap) for storage.

## Appendix A Purchasing Information

Model CA900 Sulfide Analyzer, Part # Guide						
CA900	Parameter					
	1	Alkalinity				
	2	Fluoride				
	3	Sulfide				
		<b>Range</b>				
		A	0 - 50 ppm (mg/L)			
		B	0 - 500 ppm (mg/L)			
		C	0 - 1,000 ppm (mg/L)			
			<b>Number of Channels</b>			
			1	1 Channel, Atmospheric Sampling		
			2	PH Comp – Fluoride, Sulfide ONLY		
			3	PH Comp with auto calibration Fluoride ONLY		
				<b>Analyzer Outputs</b>		
			1	(X4) 4-20 mA, (x4) Relays, Ethernet		
				<b>Sensor Material</b>		
			1	SS Sensors		
			2	Titanium Sensors		
			3	Hastelloy Sensors		
				<b>Fast Loop Sample Cell</b>		
			0	No Fast Loop Sample Cell (Standard)		
			1	Fast Loop Sample Cell (1000270-2)		
CA900	3	A	2	1	1	0



## Appendix B Parts and Accessories

Model CA900 Sulfide Analyzer: Spare Parts	
Part#	Description
2000395	KIT, TUBING, ANNUAL MAINTENANCE + QUARTERLY SAMPLE & PINCH VALVE+ ELECTRODES
2010041-1MK	REAGENT 1 MIX KIT
2010042-1MK	REAGENT 2 MIX KIT
2010472	SULFIDE SOLUTION 5PPM 500ML
2010473	SULFIDE SOLUTION 50PPM 500ML
2005122.VIT	SULFIDE ELECTRODE
2000196	REACTION CELL MOTOR ASSY
2000192-1	REAGENT MICROPUMP
9600086	MAGNETIC STIR BAR
2000193	KIT FITTINGS
9551026	O-RING REACTION CELL
2000097-1	PINCH DRAIN VALVE
2000151-1	SAMPLE PUMP
1000270-2	FAST LOOP RESERVOIR

END

LEFT BLANK



1500 North Kellogg Drive • Anaheim, CA 92807 • +1-714-695-0051 • FAX +1-714-695-0057 • [ecdi.com](http://ecdi.com)